

4G Vehicle Gateway

VHG87B-LT1B0 (dual LTE cat.4)

VHG87B-L61B0 (dual LTE cat.6)



4G Vehicle Gateway

Chapter 1 Introduction.....	7
1.1 Introduction	7
1.2 Contents List.....	8
1.2.1 Package Contents	8
1.3 Hardware Configuration.....	9
1.4 LED Indication	12
1.5 Installation & Maintenance Notice	13
1.5.1 SYSTEM REQUIREMENTS.....	13
1.5.2 WARNING	13
1.5.3 HOT SURFACE CAUTION	15
1.5.4 Product Information for CE RED Requirements	16
1.6 Hardware Installation.....	19
1.6.1 Mount the Unit	19
1.6.2 Insert the SIM Card	19
1.6.3 Install the External RF Cable and Antenna.....	20
1.6.4 Connecting DI/DO Devices.....	21
1.6.5 Connecting Serial Device.....	22
1.6.6 Connecting Power	23
1.6.7 Connecting to the Network or a Host.....	25
1.6.8 Setup by Configuring WEB UI.....	25
Chapter 2 Basic Network.....	27
2.1 WAN & Uplink	27
2.1.1 Physical Interface	28
2.1.2 Connection Setup.....	33
2.1.3 Load Balance	53
2.2 LAN & VLAN.....	58
2.2.1 Ethernet LAN.....	58
2.2.2 VLAN.....	61
2.2.3 DHCP Server	74
2.3 WiFi	82

4G Vehicle Gateway

2.3.1	WiFi Configuration	83
2.3.2	Wireless Client List	96
2.3.3	Advanced Configuration.....	98
2.4	IPv6.....	100
2.4.1	IPv6 Configuration.....	100
2.5	Port Forwarding.....	108
2.5.1	Configuration	109
2.5.2	Virtual Server & Virtual Computer	110
2.5.3	DMZ & Pass Through.....	116
2.5.4	Special AP & ALG	119
2.6	Routing	123
2.6.1	Static Routing	124
2.6.2	Dynamic Routing	127
2.6.3	Routing Information	135
2.7	DNS & DDNS.....	136
2.7.1	DNS & DDNS Configuration.....	136
2.8	QoS.....	140
2.8.1	QoS Configuration	140
Chapter 3	Object Definition	149
3.1	Scheduling.....	149
3.1.1	Scheduling Configuration.....	149
3.2	User	151
3.2.1	User List.....	151
3.2.2	User Profile.....	153
3.2.3	User Group	155
3.3	Grouping.....	157
3.3.1	Host Grouping	157
3.4	External Server	159
3.5	Certificate.....	162
3.5.1	Configuration	162

4G Vehicle Gateway

3.5.2 My Certificate.....	165
3.5.3 Trusted Certificate.....	172
3.5.4 Issue Certificate.....	179
Chapter 4 Field Communication	182
4.1 Bus & Protocol.....	182
4.1.1 Port Configuration.....	182
4.1.2 Virtual COM.....	184
Chapter 5 Security.....	195
5.1 VPN.....	195
5.1.1 IPSec.....	196
5.1.2 OpenVPN.....	204
5.1.3 L2TP	218
5.1.4 PPTP	226
5.1.5 GRE.....	233
5.2 Firewall.....	238
5.2.1 Packet Filter.....	238
5.2.2 URL Blocking.....	243
5.2.3 MAC Control.....	247
5.2.4 Content Filter	250
5.2.5 Application Filter	254
5.2.6 IPS.....	257
5.2.7 Options.....	261
5.3 Authentication	265
5.3.1 Captive Portal.....	265
5.3.2 MAC Authentication.....	269
Chapter 6 Administration.....	271
6.1 Configure & Manage	271
6.1.1 Command Script.....	272
6.1.2 TR-069	276
6.1.3 SNMP.....	281

4G Vehicle Gateway

6.1.4 Telnet & SSH	292
6.2 System Operation.....	295
6.2.1 Password & MMI.....	295
6.2.2 System Information.....	299
6.2.3 System Time	300
6.2.4 System Log	305
6.2.5 Backup & Restore	310
6.2.6 Reboot & Reset	311
6.3 FTP.....	312
6.3.1 Server Configuration	313
6.3.2 User Account.....	315
6.4 Diagnostic.....	316
6.4.1 Diagnostic Tools.....	316
6.4.2 Packet Analyzer	318
Chapter 7 Service	321
7.1 Cellular Toolkit.....	321
7.1.1 Data Usage	322
7.1.2 SMS.....	325
7.1.3 SIM PIN.....	329
7.1.4 USSD.....	334
7.1.5 Network Scan	337
7.2 SMS & Event.....	339
7.2.1 Configuration	341
7.2.2 Managing Events	348
7.2.3 Notifying Events	351
7.3 Location Tracking.....	354
7.3.1 GNSS.....	355
7.3.2 Track Viewer	361
7.4 Power Control	366
7.4.1 Ignition Sense.....	366

4G Vehicle Gateway

Chapter 8 Status.....	369
8.1 Dashboard.....	369
8.1.1 Device Dashboard.....	369
8.2 Basic Network.....	371
8.2.1 WAN & Uplink Status.....	371
8.2.2 LAN & VLAN Status.....	375
8.2.3 WiFi Status.....	376
8.2.4 DDNS Status.....	379
8.3 Security.....	380
8.3.1 VPN Status.....	380
8.3.2 Firewall Status.....	385
8.4 Administration.....	389
8.4.1 Configure & Manage Status.....	389
8.4.2 Log Storage Status.....	391
8.4.3 GNSS Status.....	392
8.5 Statistics & Report.....	393
8.5.1 Connection Session.....	393
8.5.2 Network Traffic.....	394
8.5.3 Login Statistics.....	395
8.5.4 Cellular Usage.....	396
8.5.5 Portal Usage.....	397
Appendix A GPL WRITTEN OFFER.....	398

4G Vehicle Gateway

Chapter 1 Introduction

1.1 Introduction

Congratulations on your purchase of this outstanding product: 4G Vehicle Gateway. For In-vehicle WiFi hotspot, In-vehicle telematics, and M2M (machine-to-Machine) applications, AMIT 4G Vehicle Gateway is absolutely the right choice.

With built-in world-class 4G LTE modules (*¹), you just need to insert SIM card from local mobile carrier to get to Internet. By VPN tunneling technology, remote sites easily become a part of Intranet, and all data are transmitted in a secure (256-bit AES encryption) link. The feature of DI/DO allows gateway to have real-time response whenever events are detected by sensors. To meet a variety of In-Vehicle application requirements, AMIT 4G Transit Gateway also equips GPS receiver for AVL or fleet management applications.

The VHG87B series products are loaded with luxuriant security features including VPN, firewall, NAT, port forwarding, DHCP server and many other powerful features for complex and demanding in-vehicle and M2M-IoT applications. DC 9-36V wide-range power design allows overcoming transient power in vehicles. Terminal block also secures power lines from falling out while vehicles are moving on the road.

Main Features:

- Built-in dual high speed LTE modems with 2+2 SIMs for uplink traffic failover and load balance.
- Equip gigabit Ethernet ports to connect other IP-based devices in vehicle.
- RS232 serial port for controlling legacy serial devices, such as ticketing/payment device or other control unit.
- Digital I/O ports for integrating sensors (door sensor, passenger counting), panic button, switch, or other alarm devices.
- Equip 802.11a/b/g/n/ac concurrent dualband WiFi access point especially suitable for WiFi hotspot service in vehicle.
- Work with internal / external portal and RADIUS server for user authentication or push advertisements.

Before you install and use this product, please read this manual in detail for fully exploiting the functions of this product.





¹ VHG87B-LT1B0 for dual LTE cat.4, and VHG87B-L61B0 for dual LTE cat. 6.

4G Vehicle Gateway

1.2 Contents List

1.2.1 Package Contents

#Standard Package

Items	Description	Contents	Quantity
1	VHG87B-Lx1B0 4G Vehicle Gateway(*2)		1pcs
2	Cellular Antenna		4pcs
3	2.4G/5GHz WiFi Antenna		2pcs
4	8 pin Terminal Block		1pcs
5	Mounting Bracket		2pcs

2 The maximum power consumption of VHG87B series product is 20.0W.

4G Vehicle Gateway

1.3 Hardware Configuration

➤ Front View

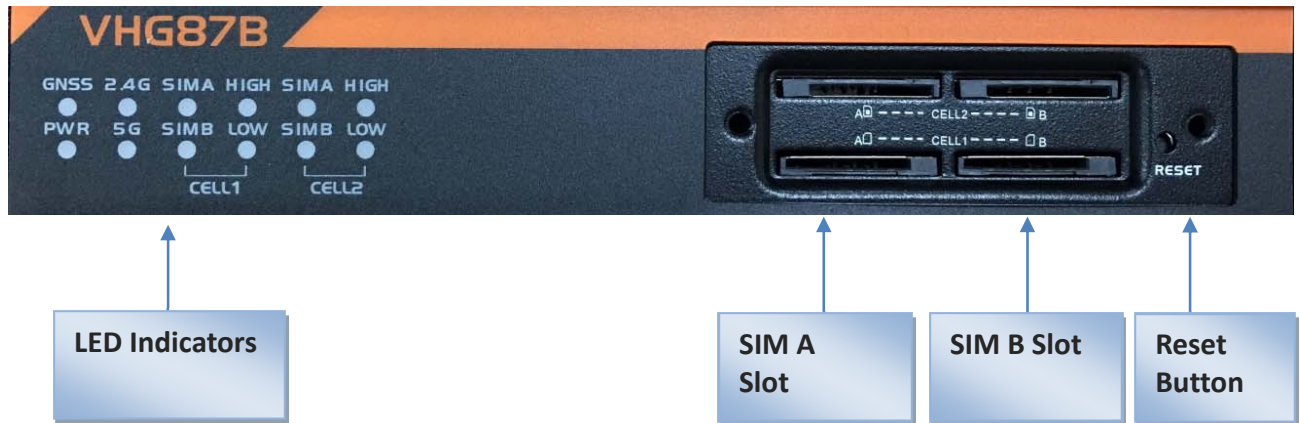

⚠️ Reset Button

The RESET button provides user with a quick and easy way to restore the default setting. Press the RESET button continuously for 6 seconds, and then release it. The device will reset settings to factory default.

4G Vehicle Gateway

➤ Rear View

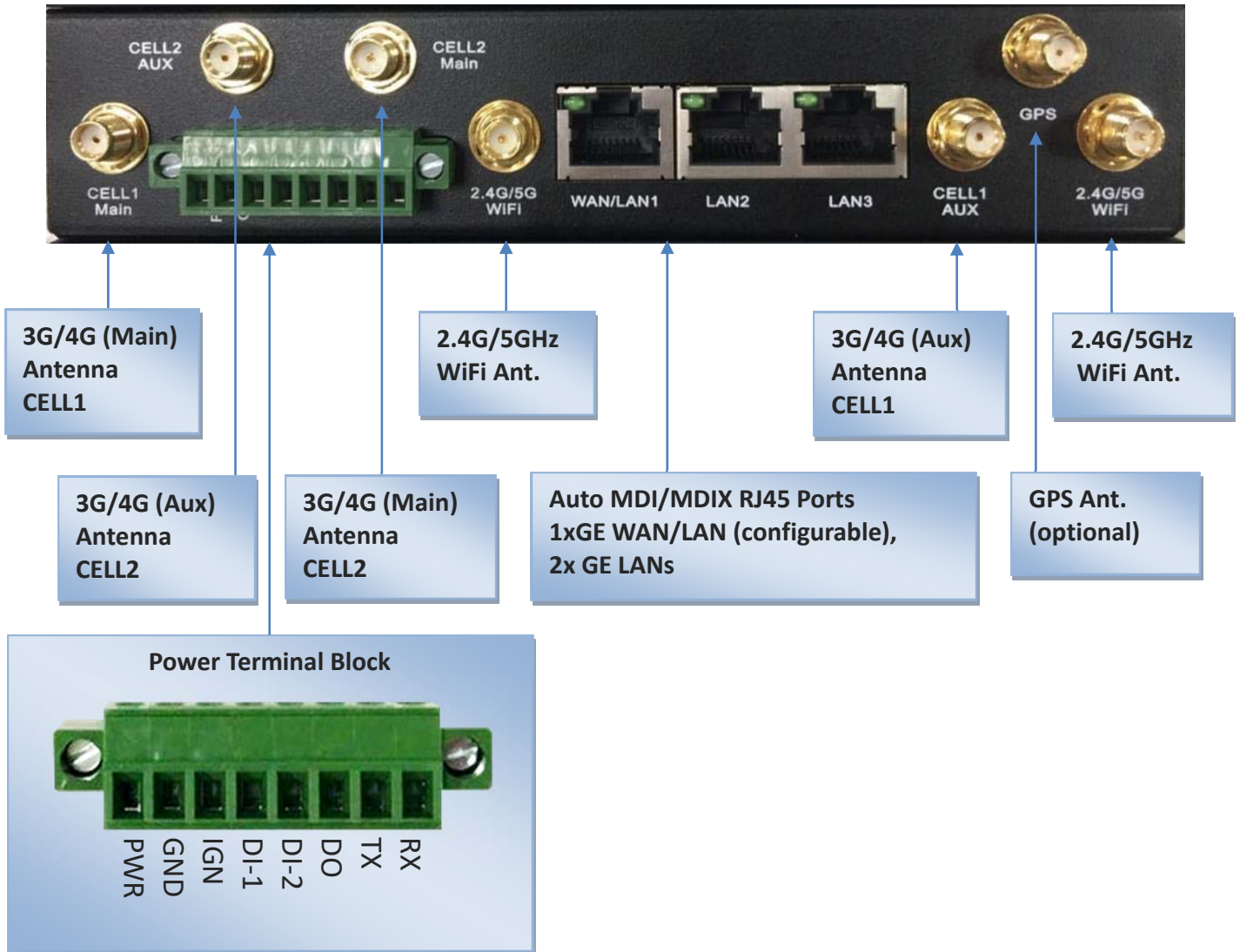

※ GPS

The intend the

Antenna

GPS Antenna is an optional accessory, and not included in the standard package. If you intend to use the provided GNSS function, please purchase required GPS antenna and install it to corresponding SMA connector in advance.

There can be different type of GNSS antenna supported by the device for different H/W version. **Refer to the HW variant identifier printed on the device label for the purchased device.**

4G Vehicle Gateway

If the label shows “EC25-x”, or “EP06-E”, “MC7430” please use an active GNSS antenna to get the best sensitivity.

4G Vehicle Gateway AMIT VHG87B

SN: _____

MAC: 00501821DCF3

IMEI: 861107034047150

IMEI: 861107038785490

WiFi Password: BvWHDVoyhRHqa

(E13)10R-05 14462

CE

EC25-E

VHG87B-LT1B0

INPUT:9V-36V,1.3A(MAX)

MADE IN TAIWAN

4G Vehicle Gateway AMIT VHG87B

SN: _____

MAC: 00501821DCF3

IMEI: 861107034047150

IMEI: 861107038785490

WiFi Password: BvWHDVoyhRHqa

(E13)10R-05 14462

CE

EP06-E

VHG87B-L61B0

INPUT:9V-36V,1.3A(MAX)

MADE IN TAIWAN

4G Vehicle Gateway AMIT VHG87B

SN: _____

MAC: 00501821DCF3

IMEI: 861107034047150

IMEI: 861107038785490

WiFi Password: BvWHDVoyhRHqa

(E13)10R-05 14462

CE

MC7430

VHG87B-L61B0

INPUT:9V-36V,1.3A(MAX)

MADE IN TAIWAN

If the label shows “ME3630-xxx”, please use a passive GNSS antenna.

4G Vehicle Gateway AMIT VHG87B

SN: _____

MAC: 00501821DCF3

IMEI: 861107034047150

IMEI: 861107038785490

WiFi Password: BvWHDVoyhRHqa

(E13)10R-05 14462

CE

ME3630-E1C

VHG87B-LT1B0

INPUT:9V-36V,1.3A(MAX)

MADE IN TAIWAN

4G Vehicle Gateway

1.4 LED Indication



LED Icon	Indication	LED Color	Description
GPS	GPS	Green	OFF: GNSS function is disabled. Steady ON: Location is fixed. Fast Flashing: Location is fixing.
PWR	Power Source	Green	OFF: Device is powered OFF or in standby mode. Steady ON: Device is powered ON. Flash once a second: Device is at “Delay OFF” mode. Fast Flashing: Firmware is upgrading or Device is in recovery mode.
2.4G	2.4GHz WiFi	Green	OFF: 2.4G WiFi is disabled. Steady ON: 2.4G WiFi is enabled. Fast Flashing: Data is transmitted/received thru 2.4G WiFi.
5G	5GHz WiFi	Green	OFF: 5G WiFi is disabled. Steady ON: 5G WiFi is enabled. Fast Flashing: Data is transmitted/received thru 5G WiFi.
SIM A	SIM A	Green	OFF: SIM card is not inserted or not used for 3G/4G connection. Steady ON: SIM Card A is inserted and being used for 3G/4G connection.
SIM B	SIM B	Green	OFF: SIM card is not inserted or not used for 3G/4G connection. Steady ON: SIM Card B is inserted and being used for 3G/4G connection.
HIGH, LOW	LTE Signal Strength	Green	HIGH - Steady ON: 3G/4G signal strength is at high level. LOW - Steady ON: 3G/4G signal strength is at low level. HIGH, LOW – Both OFF: 3G/4G disconnected.
WAN/LAN1~3	WAN/LAN 1/LAN 3	Green	Steady ON: Ethernet connection of LAN or WAN is established. Flash: Data packets are transferring.

4G Vehicle Gateway

1.5 Installation & Maintenance Notice

1.5.1 SYSTEM REQUIREMENTS

Network Requirements	<ul style="list-style-type: none">• A Gigabit Ethernet RJ45 cable or DSL modem• 3G/4G cellular service subscription• IEEE 802.11b/g/n/ac wireless clients• 10/100/1000 Ethernet adapter on PC
Web-based Configuration Utility Requirements	<p>Computer with the following:</p> <ul style="list-style-type: none">• Windows®, Macintosh, or Linux-based operating system• An installed Ethernet adapter <p>Browser Requirements:</p> <ul style="list-style-type: none">• Internet Explorer 6.0 or higher• Chrome 2.0 or higher• Firefox 3.0 or higher• Safari 3.0 or higher

1.5.2 WARNING



Attention

- This gateway can be powered by DC12V or DC24V car system. If this gateway is not installed in vehicle, a DC12V/2A power adapter is recommended.
- Do not open or repair the case yourself. If the product is too hot, turn off the power immediately and have it repaired at a qualified service center.

4G Vehicle Gateway

Federal Communication Commission Interference Statement

This device complies with Part 15 of the FCC Rules. Operation is subject to the following two conditions: (1) This device may not cause harmful interference, and (2) this device must accept any interference received, including interference that may cause undesired operation.

This equipment has been tested and found to comply with the limits for a Class B digital device, pursuant to Part 15 of the FCC Rules. These limits are designed to provide reasonable protection against harmful interference in a residential installation. This equipment generates, uses and can radiate radio frequency energy and, if not installed and used in accordance with the instructions, may cause harmful interference to radio communications. However, there is no guarantee that interference will not occur in a particular installation. If this equipment does cause harmful interference to radio or television reception, which can be determined by turning the equipment off and on, the user is encouraged to try to correct the interference by one of the following measures:

- Reorient or relocate the receiving antenna.
- Increase the separation between the equipment and receiver.
- Connect the equipment into an outlet on a circuit different from that to which the receiver is connected.
- Consult the dealer or an experienced radio/TV technician for help.

FCC Caution: Any changes or modifications not expressly approved by the party responsible for compliance could void the user's authority to operate this equipment.

This transmitter must not be co-located or operating in conjunction with any other antenna or transmitter.

FOR PORTABLE DEVICE USAGE (<20m from body/SAR needed)

Radiation Exposure Statement:

The product comply with the FCC portable RF exposure limit set forth for an uncontrolled environment and are safe for intended operation as described in this manual. The further RF exposure reduction can be achieved if the product can be kept as far as possible from the user body or set the device to lower output power if such function is available.

FOR MOBILE DEVICE USAGE (>20cm/low power)

Radiation Exposure Statement:

This equipment complies with FCC radiation exposure limits set forth for an uncontrolled environment. This equipment should be installed and operated with minimum distance 20cm between the radiator & your body.

FOR COUNTRY CODE SELECTION USAGE (WLAN DEVICES)

Note: The country code selection is for non-US model only and is not available to all US model. Per FCC regulation, all WiFi product marketed in US must fixed to US operation channels only.

4G Vehicle Gateway

1.5.3 HOT SURFACE CAUTION



CAUTION: The surface temperature for the metallic enclosure can be very high! Especially after operating for a long time, installed at a closed cabinet without air conditioning support, or in a high ambient temperature space.

DO NOT touch the hot surface with your fingers while servicing!!

4G Vehicle Gateway

1.5.4 Product Information for CE RED Requirements

The following product information is required to be presented in product User Manual for latest CE RED requirements.³

(1) Frequency Band & Maximum Power

1.a Frequency Band for Cellular Connection (for EC25-E version)

Band number	Operating Frequency	Max output power
LTE FDD BAND 1	Uplink: 1920-1980 MHz Downlink: 2110-2170 MHz	23.1 dBm
LTE FDD BAND 3	Uplink: 1710-1785 MHz Downlink: 1805-1880 MHz	23.0 dBm
LTE FDD BAND 7	Uplink: 2500-2570 MHz Downlink: 2620-2690 MHz	22.8 dBm
LTE FDD BAND 8	Uplink: 880-915 MHz Downlink: 925-960 MHz	23.2 dBm
LTE FDD BAND 20	Uplink: 832-862 MHz Downlink: 791-821 MHz	23.5 dBm
LTE FDD BAND 38	Uplink: 2570-2620 MHz Downlink: 2570-2620 MHz	21.7 dBm
LTE FDD BAND 40	Uplink: 2300-2400 MHz Downlink: 2300-2400 MHz	21.5 dBm
WCDMA BAND 1	Uplink: 1920-1980 MHz Downlink: 2110-2170 MHz	23.3 dBm
WCDMA BAND 8	Uplink: 880-915 MHz Downlink: 925-960 MHz	
E-GSM	Uplink: 880-915 MHz Downlink: 925-960 MHz	32.9 dBm
DCS	Uplink: 1710-1785 MHz Downlink: 1805-1880 MHz	29.9 dBm

1.b Frequency Band for Cellular Connection (for ME3630 E1C version)

Band number	Operating Frequency	Max output power
LTE FDD BAND 1	Uplink: 1920-1980 MHz Downlink: 2110-2170 MHz	23 ±2.7 dBm
LTE FDD BAND 3	Uplink: 1710-1785 MHz Downlink: 1805-1880 MHz	
LTE FDD BAND 7	Uplink: 2500-2570 MHz Downlink: 2620-2690 MHz	
LTE FDD BAND 8	Uplink: 880-915 MHz	

³ The information presented in this section is ONLY valid for the EU/EFTA regional version. For those non-CE/EFTA versions, please refer to the corresponding product specification.

4G Vehicle Gateway

	Downlink: 925-960 MHz	
LTE FDD BAND 20	Uplink: 832-862 MHz Downlink: 791-821 MHz	
WCDMA BAND 1	Uplink: 1920-1980 MHz Downlink: 2110-2170 MHz	24 +1/-3 dBm
WCDMA BAND 8	Uplink: 880-915 MHz Downlink: 925-960 MHz	
E-GSM	Uplink: 880-915 MHz Downlink: 925-960 MHz	33 ±2 dBm
DCS	Uplink: 1710-1785 MHz Downlink: 1805-1880 MHz	30 ±2 dBm

1.c Frequency Band for Wi-Fi Connection

Band	Operating Frequency	Max. Output Power (EIRP)
2.4G	2.4 – 2.4835 GHz	100 mW
5G	5.15 – 5.25 GHz	200 mW

(2) 5150 ~ 5350MHz In Door Use Statements

This product equips the IEEE 802.11ac compliance 5GHz wireless radio module. According to the RED requirement, the channels covered in the 5150 ~ 5350 MHz frequency band are In Door Use Only.

(3) Countries List for Restrictions (for products with 5GHz radio)

For EU/EFTA, this product can be used in all EU member states and EFTA countries.

						
AT	BE	BG	CH	CY	CY	DK
DE	EE	EL	ES	FI	FR	HR
HU	IE	IT	LT	LU	LV	MT
NL	NO	PL	PT	RO	SI	SK
SE	TR	UK				

4G Vehicle Gateway

(4) DoC Information

You can get the DoC information of this product from the following URL:

<http://www.amitwireless.com/products-doc/>

(5) RF Exposure Statements

The antenna of the product, under normal use condition, is at least 20 cm away from the body of user.

(6) Unit Mounting Notice

The product is suitable for mounting at heights $\leq 2\text{m}$ (approx. 6 ft), or in a cabinet.

Ensure the unit is fixed tightly to reduce the likelihood of injury due to exposure to mechanical hazards if dropped.

(7) Manufacture Information

Manufacture Name: AMIT Wireless Inc.

Manufacture Address: No. 28, Lane 31, Sec. 1, Huandong Rd., Xinshi Dist., Tainan 74146, Taiwan (R.O.C.)

4G Vehicle Gateway

1.6 Hardware Installation

This chapter describes how to install and configure the hardware

1.6.1 Mount the Unit

The VH87B series products can be mounted on a wall, or horizontal plane with the mounting accessories (brackets). The mounting accessories are not screwed on the product when out of factory. Please screw the mounting brackets on the product first.

1.6.2 Insert the SIM Card

WARNING: BEFORE INSERTING OR CHANGING THE SIM CARD, PLEASE MAKE SURE THE GATEWAY IS POWERED OFF.

The SIM card slots are located at the front side of the device housing. You need to unscrew and remove the outer SIM card cover before installing or removing the SIM card. Please follow the instructions to insert or eject a SIM card. After SIM card is well placed, screw back the outer SIM card cover.

Step 1:

Loosen the screws as below and remove the SIM cover.



Step 2:

Push the SIM card into the SIM slot A or slot B for each cellular module.

Cellular-1



Cellular-2



Step 3:

Push the inserted SIM card again to eject it from the SIM slot.



4G Vehicle Gateway

1.6.3 Install the External RF Cable and Antenna

As illustrated in Section 1.3, there are several SMA antenna Jacks for you to install the required RF cables and antennas for the RF signal transmission and receiving. You have to purchase required RF cables and antennas separately for a specific project or installation site to get excellent RF performance.

Since there is limited spacing for allocating all SMA antenna Jacks around the enclosure, the separation among SMA Jacks (or direct-attached antennas) could be not the optimized arrangement. **It is not recommended to attach the SMA antennas directly to the SMA Jacks.** It is very likely to get degraded RF performance at specific circumstances. It depends heavily on the environment.

However, there are well-known rules of thumb for solving the antenna separation issue.

- 1: The horizontal distance between antennas should be greater than 1/4 of its wavelength, and there will be best separation at 1/2 of its wavelength.*
- 2. If multiple frequency antennas are near each other, then use spacing distance of the lower frequency antenna, or even better try to satisfy the rule for both frequencies.*

Wavelength Table for Major RF Category

RF Category	Frequency	Wavelength	1/2 Wave Length (Best Separation)	1/4 Wave Length (Good Separation)
WiFi 802.11	5.8GHz	5.2cm	2.6cm	1.3cm
WiFi 802.11	2.4GHz	12.5cm	6.2cm	3.1cm
Cellular LTE	2600MHz	11.5cm	5.8cm	2.9cm
Cellular LTE	2100MHz	14.3cm	7.1cm	3.7cm
Cellular LTE	900MHz	33.3cm	16.6cm	8.3cm
Cellular LTE	700MHz	42.8cm	21.4cm	10.7cm
GPS	1.57GHz	19.0cm	9.5cm	4.7cm

For example, if you have a 900MHz LTE antenna and a WiFi 2.4GHz antenna, you would want them to be separated by at least 8.3cm to get good antenna separation.

So, it is recommended to use some external RF cables to extend and separate the adjacent antennas and get better antenna separation and RF performance, if required.

4G Vehicle Gateway

1.6.4 Connecting DI/DO Devices

There are two DI, and one DO ports together with power terminal block. Please refer to following specification to connect DI and DO devices.



DI -1-
DI -2+
DO

Mode	Specification	
Digital Input	Trigger Voltage (high)	Logic level 1: 5V~30V
	Normal Voltage (low)	Logic level 0: 0V~1.0V
Digital Output	Voltage (Relay Mode)	Logic Level 1: Depends on external power source (*4) (maximum voltage is 36V) Logic Level 0: Floating, External Pull-Down Resistor (10K Ohm, 1/2W) is required.
	Maximum Current	1A@12V, or 0.33A@36V

Example of Connection Diagram

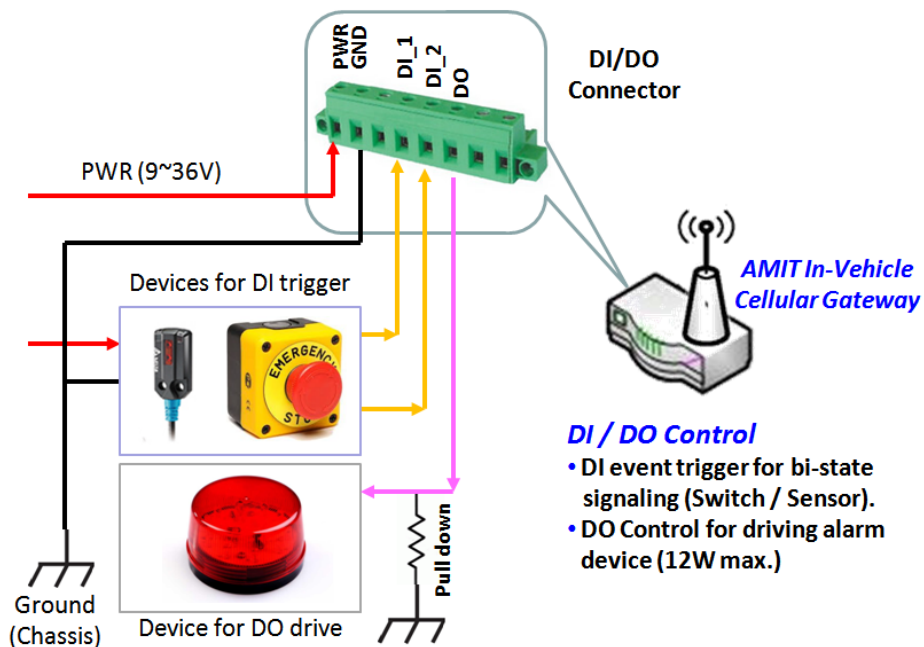

4 Power of DO is relayed from "PWR" pin in same 8-pin terminal block connector.

4G Vehicle Gateway

1.6.5 Connecting Serial Device

The VH87B series products provide one RS-232 port with TX and RX signals located in the terminal block connector, as shown below. Connect the serial device to the unit TX/RX ports with the right pin assignments of a RS-232 cable.



4G Vehicle Gateway

1.6.6 Connecting Power

The VH87B series product can be powered by connecting a power source to the terminal block. **It supports 9V to 36V DC power input.** Following picture is the power terminal block pin assignments. Please check carefully and connect to the right power requirements and polarity.

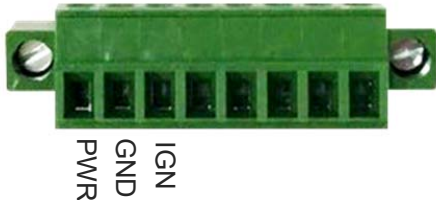

There are two ways of connecting power in vehicle depends on ignition sense feature is enabled or not. If Ignition Sense is disabled (*5), please follow the diagram below for power connection.

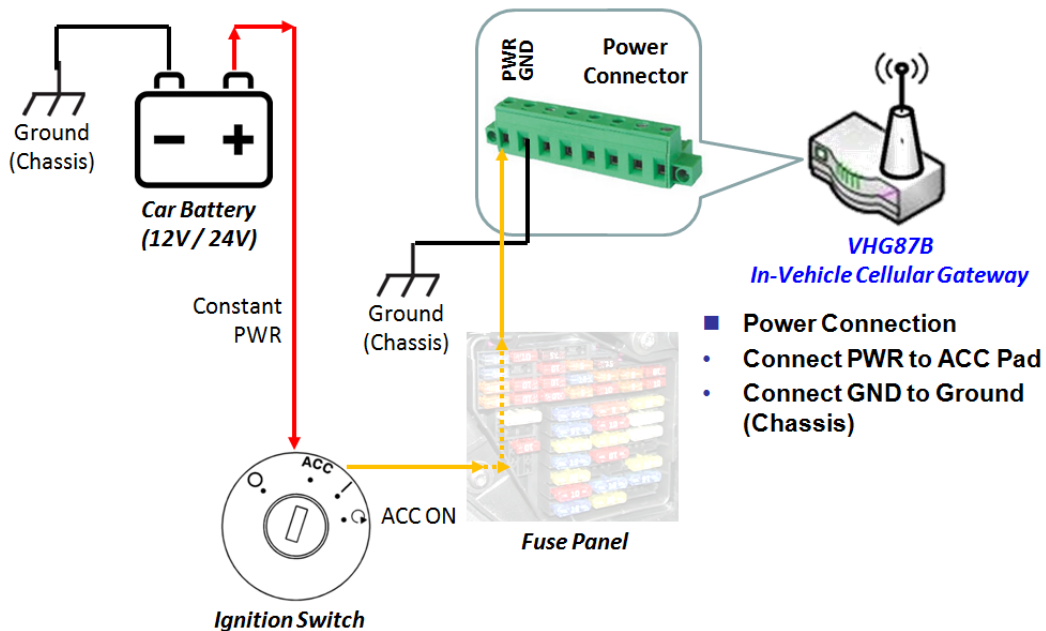

Attention

The **ignition sense** feature is **DISABLED** by default. With this default setting, power pin should be connected to ACC power. **DO NOT** connect power pin to constant power from car battery. Otherwise, this gateway device will drain battery power out.

5 The function of ignition sense is disabled by default. IGN pin won't be used with this setting.

4G Vehicle Gateway

Besides, with a provision of IGN (Ignition Sense) Power Control function, the VHG87B series product can be powered by Car battery and operates with the benefits for delay OFF, and low battery shutdown feature. That is, the gateway can still operate for a certain time period even the vehicle power has been switched off.

To use such function, please properly connect the PWR / GND / IGN ports to the pads located in vehicle fuse panel (refer the the following diagram), and activate the Power Control (*⁶) function through web UI configuration (refer to Section 7.4).

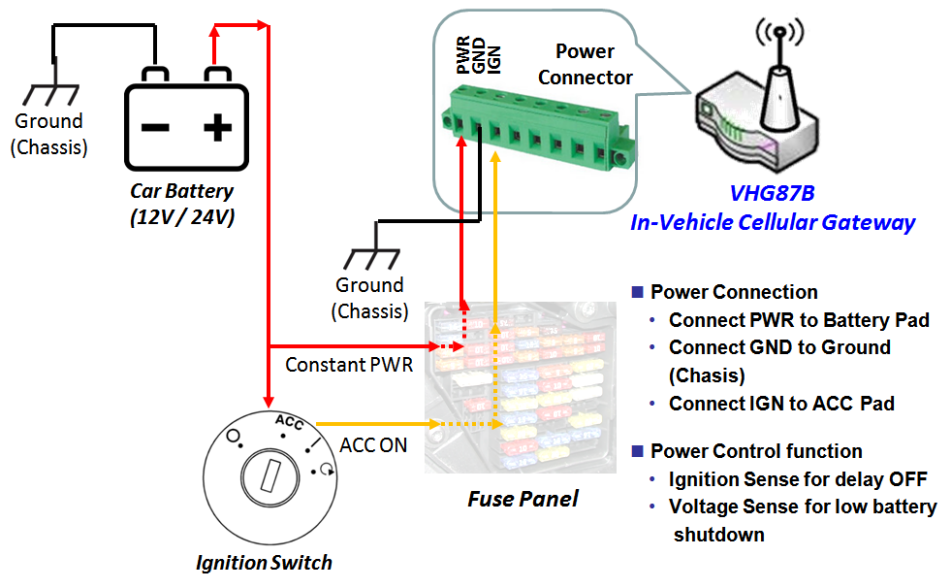

Attention

If PWR pin is connected to constant power from car battery, please make sure IGN pin is well connected to ACC pad and Ignition Sense feature (Service->Power Control->Ignition Sense) is ENABLED. Otherwise, this gateway device may drain battery power out.

⁶ If enabling ignition sense function, this gateway device won't be powered on until voltage is detected on IGN pin.

4G Vehicle Gateway

1.6.7 Connecting to the Network or a Host

The VHG87B series products provide three RJ45 ports to connect 10/100/1000Mbps Ethernet. It can auto detect the transmission speed on the network and configure itself automatically. Connect one Ethernet cable to the RJ45 port (LAN) of the device and plug another end of the Ethernet cable into your computer's network port. In this way, you can use the RJ45 Ethernet cable to connect to the host PC's Ethernet port for configuring the device.

1.6.8 Setup by Configuring WEB UI

You can browse web UI to configure the device.

Type in the IP Address (<http://192.168.123.254>)⁷



When you see the login page, enter the user name and password and then click '**Login**' button. The default setting for both username and password is '**admin**'.

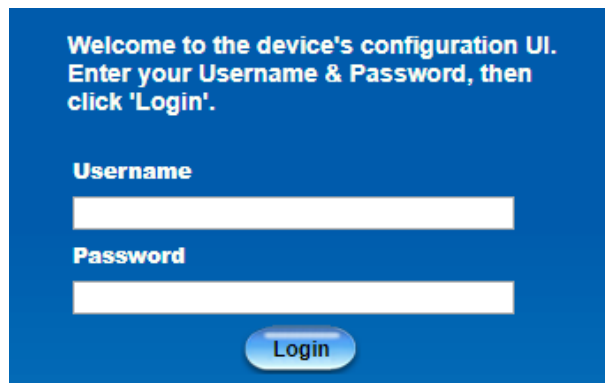

For the security consideration, you will be asked to change the logging password while the first time login to the device.

⁷ The default LAN IP address of this gateway is 192.168.123.254. If you change it, you need to login by using the new IP address.

4G Vehicle Gateway

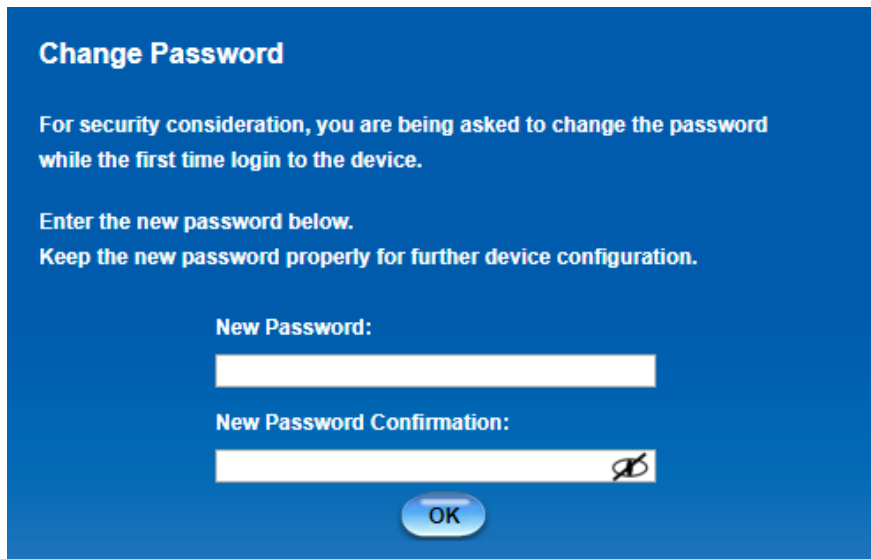

Change Password

For security consideration, you are being asked to change the password while the first time login to the device.

Enter the new password below.
Keep the new password properly for further device configuration.

New Password:

New Password Confirmation:

OK

After that, you will be asked to login again with the new password.

Note 1: Keep the login password properly for further device configuration.

Note 2: If, someday, you lose or forget the login password, the ONLY way to remedy is to recover the device to its factory default settings via long-pressing the Reset button.

Note 3: Under such situation, your device configuration will be erased accordingly. So, In addition to keep the login password, you may have to backup the device donfiguration and keep it properly for any unexpected accident.

4G Vehicle Gateway

Chapter 2 Basic Network

2.1 WAN & Uplink

The left side shows a vertical navigation menu with buttons: Basic Network, WAN & Uplink, Physical Interface, Internet Setup, Loading Balance, and End. The right side is a screenshot of the 'Physical Interface List' configuration page. The page has a breadcrumb trail: Physical Interface > Connection Setup > Load Balance. The main content is a table with the following data:

Interface Name	Physical Interface	Operation Mode	Action
WAN-1	Ethernet	Always on	Edit
WAN-2	3G/4G 1	Always on	Edit
WAN-3	-	Disable	Edit

The gateway provides multiple WAN interfaces to let all client hosts in Intranet of the gateway access the Internet via ISP. But ISPs in the world apply various connection protocols to let gateways or user's devices dial in ISPs and then link to the Internet via different kinds of transmit media.

So, the WAN Connection lets you specify the WAN Physical Interface, WAN Internet Setup and WAN Load Balance for Intranet to access Internet. For each WAN interface, you must specify its physical interface first and then its Internet setup to connect to ISP. Besides, since the gateway has multiple WAN interfaces, you can assign physical interface to participate in the Load Balance function.

4G Vehicle Gateway

2.1.1 Physical Interface

The flowchart on the left illustrates the configuration process: **Physical Interface** (blue box) leads to **L4 List**, then to **Physical Interface List** (blue box), then to **Popup**, then to **Interface Configuration** (blue box), then to **Select**, then to **Physical Interface** (hexagon), then to **Select**, then to **Operation Mode** (hexagon) with sub-points **Always on** and **Fail-Over**, and finally to a close icon (circle with an X).

The screenshots on the right show the **Physical Interface List** table and the **Interface Configuration (WAN - 1)** form.

Interface Name	Physical Interface	Operation Mode	Action
WAN-1	Ethernet	Always on	Edit
WAN-2	3G/4G 1	Always on	Edit
WAN-3	-	Disable	Edit

Item	Setting
Physical Interface	Ethernet ▾
Operation Mode	Always on ▾
VLAN Tagging	<input type="checkbox"/> Enable 2 (1-4095)

M2M gateways are usually equipped with various WAN interfaces to support different WAN connection scenario for requirement. You can configure the WAN interface one by one to get proper internet connection setup. **Refer to the product specification for the available WAN interfaces in the product you purchased.**

The first step to configure one WAN interface is to specify which kind of connection media to be used for the WAN connection, as shown in "Physical Interface" page.

In "Physical Interface" page, there are two configuration windows, "Physical Interface List" and "Interface Configuration". "Physical Interface List" window shows all the available physical interfaces. After clicking on the "Edit" button for the interface in "Physical Interface List" window the "Interface Configuration" window will appear to let you configure a WAN interface.

Physical Interface:

- **Ethernet WAN:** The gateway has one or more RJ45 WAN ports that can be configured to be WAN connections. You can directly connect to external DSL modem or setup behind a firewall device.
- **3G/4G WAN:** The gateway has built-in two 3G/4G cellular modules as WAN connections. For each cellular WAN, there are 1 or 2 SIM cards to be inserted for special failover function.

4G Vehicle Gateway



- Please **MUST POWER OFF** the gateway before you insert or remove SIM card.
- The SIM card can be damaged if you insert or remove SIM card while the gateway is in operation.

Operation Mode:

There are three option items “Always on”, “Failover”, and “Disable” for the operation mode setting.

Always on: Set this WAN interface to be active all the time. When two or more WAN are established at "Always on" mode, outgoing data will through these WAN connections base on load balance policies.

Failover:

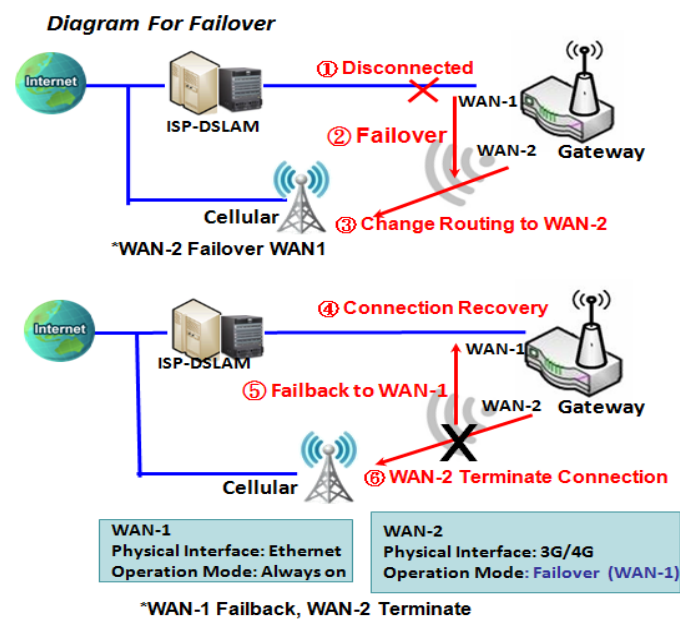

A failover interface is a backup connection to the primary. That means only when its primary WAN connection is broken, the backup connection will be started up to substitute the primary connection. As shown in the diagram, WAN-2 is backup WAN for WAN-1. WAN-1 serves as the primary connection with operation mode "Always on". WAN-2 won't be activated until WAN-1 disconnected. When WAN-1 connection is recovered back with a connection, it will take over data traffic again. At that time, WAN-2 connection will be terminated.

4G Vehicle Gateway

Seamless Failover:

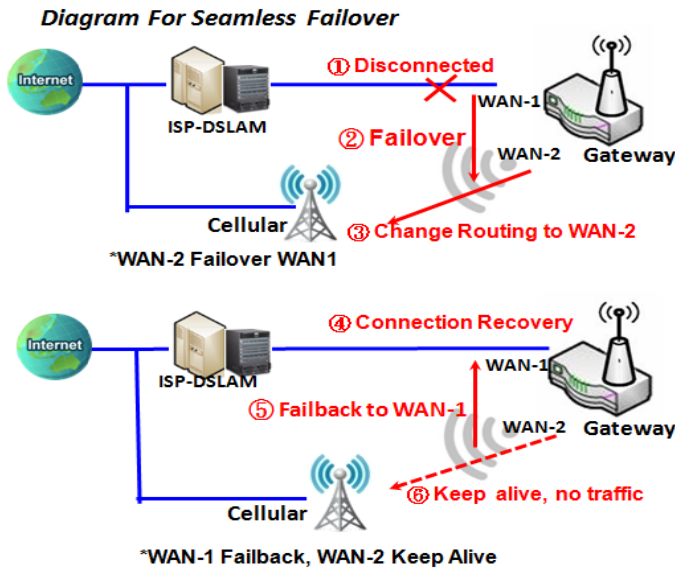

In addition, there is a "Seamless" option for Failover operation mode. When seamless option is activated by checking on the "Seamless" box in configuration window, both the primary connection and the failover connection are started up after system rebooting. But only the primary connection executes the data transfer, while the failover one just keeps alive of connection line. As soon as the primary connection is broken, the system will switch, meaning failover, the routing path to the failover connection to save the dial up time of failover connection since it has been alive.

When the "Seamless" enable checkbox is activated, it can allow the Failover interface to be connected continuously from system booting up. Failover WAN interface just keeps connecting without data traffic.

The purpose is to shorten the switch time during failover process. So, when primary connection is disconnected, failover interface will take over the data transfer mission instantly by only changing routing path to the failover interface. The dialing-up time of failover connection is saved since it has been connected beforehand.

VLAN Tagging

Sometimes, your ISP required a VLAN tag to be inserted into the WAN packets from Gateway for specific services. Please enable VLAN tagging and specify tag in the WAN physical interface. Please be noted that only Ethernet and ADSL physical interfaces support the feature. For the device with 3G/4G WAN only, it is disabled.

4G Vehicle Gateway

Physical Interface Setting

Go to **Basic Network > WAN > Physical Interface** tab.

The Physical Interface allows user to setup the physical WAN interface and to adjust WAN's behavior.

Note: Numbers of available WAN Interfaces can be different for the purchased gateway.

Physical Interface List			
Interface Name	Physical Interface	Operation Mode	Action
WAN-1	Ethernet	Always on	Edit
WAN-2	3G/4G 1	Always on	Edit
WAN-3	-	Disable	Edit

When **Edit** button is applied, an **Interface Configuration** screen will appear. WAN-1 interface is used in this example.

Interface Configuration:

Interface Configuration (WAN - 1)	
Item	Setting
▶ Physical Interface	Ethernet ▼
▶ Operation Mode	Always on ▼
▶ VLAN Tagging	<input type="checkbox"/> Enable <input type="text" value="2"/> (1-4095)

Interface Configuration		
Item	Value setting	Description
Physical Interface	1. A Must fill setting 2. WAN-1 is the primary interface and is factory set to Always on.	Select one expected interface from the available interface dropdown list. Depending on the gateway model, Disable and Failover options will be available only to multiple WAN gateways. WAN-2 ~ WAN-4 interfaces are only available to multiple WAN gateway.
Operation Mode	A Must fill setting	Define the operation mode of the interface. Select Always on to make this WAN always active. Select Disable to disable this WAN interface.

4G Vehicle Gateway

		<p>Select Failover to make this WAN a Failover WAN when the primary or the secondary WAN link failed. Then select the primary or the existed secondary WAN interface to switch Failover from.</p> <p>(Note: for WAN-1, only Always on option is available.)</p>
VLAN Tagging	Optional setting	<p>Check Enable box to enter tag value provided by your ISP. Otherwise uncheck the box.</p> <p><u>Value Range: 1 ~ 4095.</u></p> <p>Note: This feature is NOT available for 3G/4G WAN connection.</p>

4G Vehicle Gateway

2.1.2 Connection Setup

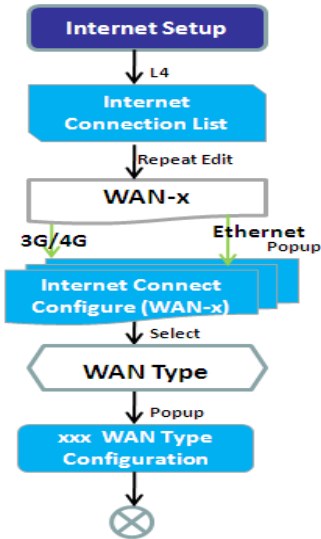

Internet Connection List				
Interface Name	Physical Interface	Operation Mode	WAN Type	Action
WAN-1	Ethernet	Always on	Static IP	<input type="button" value="Edit"/>
WAN-2	3G/4G	Always on	3G/4G	<input type="button" value="Edit"/>
WAN-3	-	Disable	-	<input type="button" value="Edit"/>
WAN-4	-	Disable	-	<input type="button" value="Edit"/>

Internet Connection Configuration (WAN - 1)	
Item	Setting
▶ WAN Type	Dynamic IP ▼

Dynamic IP WAN Type Configuration	
Item	Setting
▶ Host Name	<input type="text"/> (Optional)
▶ ISP Registered MAC Address	<input type="text"/> (Optional)
▶ Connection Control	Auto-reconnect ▼
▶ MTU Setup	<input type="checkbox"/> Enable
▶ NAT	<input checked="" type="checkbox"/> Enable
▶ IGMP	Disable ▼
▶ WAN IP Alias	<input type="checkbox"/> Enable <input type="text" value="10.0.0.1"/>

After specifying the physical interface for each WAN connection, administrator must configure their connection profile to meet the dial in process of ISP, so that all client hosts in the Intranet of the gateway can access the Internet.

In "Connection Setup" page, there are some configuration windows: "Internet Connection List", "Internet Connection Configuration", "WAN Type Configuration" and related configuration windows for each WAN type. For the Internet setup of each WAN interface, you must specify its WAN type of physical interface first and then its related parameter configuration for that WAN type.

After clicking on the "Edit" button of a physical interface in "Internet Setup List" window, the "Internet Connection Configuration" window will appear to let you specify which kind of WAN type that you will use for that physical interface to make an Internet connection. Based on your chosen WAN type, you can configure necessary parameters in each corresponding configuration window.

4G Vehicle Gateway

Internet Connection List - Ethernet WAN

Item	Setting
▶ WAN Type	Dynamic IP ▼ Static IP
▶ Dynamic IP WAN Type Configuration	Dynamic IP PPPoE PPTP L2TP
▶ Host Name	(Optional)
▶ ISP Registered MAC Address	Clone (Optional)
▶ Connection Control	Auto-reconnect ▼
▶ MTU Setup	<input type="checkbox"/> Enable
▶ NAT	<input checked="" type="checkbox"/> Enable
▶ IGMP	Disable ▼
▶ WAN IP Alias	<input type="checkbox"/> Enable 10.0.0.1
▶ Network Monitoring Configuration	
▶ Network Monitoring Configuration	<input checked="" type="checkbox"/> Enable
▶ Checking Method	DNS Query ▼
▶ Loading Check	<input checked="" type="checkbox"/> Enable
▶ Query Interval	5 (seconds)
▶ Latency Threshold	3000 (ms)

WAN Type for Ethernet Interface:

Ethernet is the most common WAN and uplink interface for M2M gateways. Usually it is connected with xDSL or cable modem for you to setup the WAN connection. There are various WAN types to connect with ISP.

- **Static IP:** Select this option if ISP provides a fixed IP to you when you subscribe the service. Usually is more expensive but very important for cooperate requirement.
- **Dynamic IP:** The assigned IP address for the WAN by a DHCP server is different every time. It is cheaper and usually for consumer use.
- **PPP over Ethernet:** As known as PPPoE. This WAN type is widely used for ADSL connection. IP is usually different for every dial up.
- **PPTP:** This WAN type is popular in some countries, like Russia.
- **L2TP:** This WAN type is popular in some countries, like Israel.

Configure Ethernet WAN Setting

When **Edit** button is applied, **Internet Connection Configuration** screen will appear. WAN-1 interface is used in this example.

4G Vehicle Gateway

WAN Type = Dynamic IP

Internet Connection Configuration (WAN - 1)	
Item	Setting
▶ WAN Type	Dynamic IP ▼

When you select it, "Dynamic IP WAN Type Configuration" will appear. Items and setting is explained below

Dynamic IP WAN Type Configuration	
Item	Setting
▶ Host Name	<input type="text"/> (Optional)
▶ ISP Registered MAC Address	<input type="text"/> <input type="button" value="Clone"/> (Optional)

Dynamic IP WAN Type Configuration		
Item	Value setting	Description
Host Name	An optional setting	Enter the host name provided by your Service Provider.
ISP Registered MAC Address	An optional setting	Enter the MAC address that you have registered with your service provider. Or Click the Clone button to clone your PC's MAC to this field. Usually this is the PC's MAC address assigned to allow you to connect to Internet.

WAN Type= Static IP

Internet Connection Configuration (WAN - 1)	
Item	Setting
▶ WAN Type	Static IP ▼

When you select it, "Static IP WAN Type Configuration" will appear. Items and setting is explained below

Static IP WAN Type Configuration	
Item	Setting
▶ WAN IP Address	<input type="text"/>
▶ WAN Subnet Mask	255.255.255.0 (/24) ▼
▶ WAN Gateway	<input type="text"/>
▶ Primary DNS	<input type="text"/>
▶ Secondary DNS	<input type="text"/> (Optional)

4G Vehicle Gateway

Static IP WAN Type Configuration		
Item	Value setting	Description
WAN IP Address	A Must filled setting	Enter the WAN IP address given by your Service Provider
WAN Subnet Mask	A Must filled setting	Enter the WAN subnet mask given by your Service Provider
WAN Gateway	A Must filled setting	Enter the WAN gateway IP address given by your Service Provider
Primary DNS	A Must filled setting	Enter the primary WAN DNS IP address given by your Service Provider
Secondary DNS	An optional setting	Enter the secondary WAN DNS IP address given by your Service Provider

WAN Type= PPPoE

Internet Connection Configuration (WAN - 1)

Item	Setting
▶ WAN Type	PPPoE ▼

When you select it, "PPPoE WAN Type Configuration" will appear. Items and setting is explained below

PPPoE WAN Type Configuration

Item	Setting
▶ IP Type	IPv4 ▼
▶ PPPoE Account	<input type="text"/>
▶ PPPoE Password	<input type="text"/>
▶ Primary DNS	<input type="text"/> (Optional)
▶ Secondary DNS	<input type="text"/> (Optional)
▶ Service Name	<input type="text"/> (Optional)
▶ Assigned IP Address	<input type="text"/> (Optional)

PPPoE WAN Type Configuration		
Item	Value setting	Description
PPPoE Account	A Must filled setting	Enter the PPPoE User Name provided by your Service Provider.
PPPoE Password	A Must filled setting	Enter the PPPoE password provided by your Service Provider.
Primary DNS	An optional setting	Enter the IP address of Primary DNS server.
Secondary DNS	An optional setting	Enter the IP address of Secondary DNS server.
Service Name	An optional setting	Enter the service name if your ISP requires it
Assigned IP Address	An optional setting	Enter the IP address assigned by your Service Provider.

4G Vehicle Gateway

WAN Type= PPTP

Internet Connection Configuration (WAN - 1)	
Item	Setting
▶ WAN Type	PPTP ▼

When you select it, "PPTP WAN Type Configuration" will appear. Items and setting is explained below

PPTP WAN Type Configuration	
Item	Setting
▶ IP Mode	Dynamic IP Address ▼
▶ Server IP Address / Name	<input type="text"/>
▶ PPTP Account	<input type="text"/>
▶ PPTP Password	<input type="text"/>
▶ Connection ID	<input type="text"/> (Optional)
▶ MPPE	<input type="checkbox"/> Enable

PPTP WAN Type Configuration		
Item	Value setting	Description
IP Mode	A Must filled setting	Select either Static or Dynamic IP address for PPTP Internet connection. <ul style="list-style-type: none"> ● When Static IP Address is selected, you will need to enter the WAN IP Address, WAN Subnet Mask, and WAN Gateway. <ul style="list-style-type: none"> ■ WAN IP Address (A Must filled setting): Enter the WAN IP address given by your Service Provider. ■ WAN Subnet Mask (A Must filled setting): Enter the WAN subnet mask given by your Service Provider. ■ WAN Gateway (A Must filled setting): Enter the WAN gateway IP address given by your Service Provider. ● When Dynamic IP is selected, there are no above settings required.
Server IP Address/Name	A Must filled setting	Enter the PPTP server name or IP Address.
PPTP Account	A Must filled setting	Enter the PPTP username provided by your Service Provider.
PPTP Password	A Must filled setting	Enter the PPTP connection password provided by your Service Provider.
Connection ID	An optional setting	Enter a name to identify the PPTP connection.
MPPE	An optional setting	Select Enable to enable MPPE (Microsoft Point-to-Point Encryption) security for PPTP connection.

4G Vehicle Gateway

WAN Type= L2TP

Internet Connection Configuration (WAN - 1)	
Item	Setting
▶ WAN Type	L2TP ▼

When you select it, "L2TP WAN Type Configuration" will appear. Items and setting is explained below

L2TP WAN Type Configuration	
Item	Setting
▶ IP Mode	Dynamic IP Address ▼
▶ Server IP Address / Name	<input type="text"/>
▶ L2TP Account	<input type="text"/>
▶ L2TP Password	<input type="text"/>
▶ Service Port	User-defined ▼ <input type="text" value="1702"/>
▶ MPPE	<input type="checkbox"/> Enable

L2TP WAN Type Configuration		
Item	Value setting	Description
IP Mode	A Must filled setting	<p>Select either Static or Dynamic IP address for L2TP Internet connection.</p> <ul style="list-style-type: none"> ● When Static IP Address is selected, you will need to enter the WAN IP Address, WAN Subnet Mask, and WAN Gateway. <ul style="list-style-type: none"> ■ WAN IP Address (A Must filled setting): Enter the WAN IP address given by your Service Provider. ■ WAN Subnet Mask (A Must filled setting): Enter the WAN subnet mask given by your Service Provider. ■ WAN Gateway (A Must filled setting): Enter the WAN gateway IP address given by your Service Provider. ● When Dynamic IP is selected, there are no above settings required.
Server IP Address/Name	A Must filled setting	Enter the L2TP server name or IP Address.
L2TP Account	A Must filled setting	Enter the L2TP username provided by your Service Provider.
L2TP Password	A Must filled setting	Enter the L2TP connection password provided by your Service Provider.
Service Port	A Must filled setting	<p>Enter the service port that the Internet service.</p> <p>There are three options can be selected :</p> <ul style="list-style-type: none"> ● Auto: Port will be automatically assigned. ● 1701 (For Cisco): Set service port to port 1701 to connect to CISCO server. ● User-defined: enter a service port provided by your Service Provider.
MPPE	An optional setting	Select Enable to enable MPPE (Microsoft Point-to-Point Encryption) security for PPTP connection.

4G Vehicle Gateway

Ethernet Connection Common Configuration

```

graph TD
    Start([Common Configure]) --> SelectConn[Select Connection Control]
    SelectConn --> Setup[Setup]
    Setup --> CheckNAT{•MTU  
•NAT Enable?}
    CheckNAT -- Enable --> NetworkMonitor{Network Monitor}
    NetworkMonitor -- No --> End(( ))
    NetworkMonitor -- Yes --> SelectDNS[Select DNS Query  
•ICMP Checking]
    SelectDNS --> SetupDNS[Setup]
    SetupDNS --> CheckParams[•Loading Check?  
•Check Interval  
•Check Timeout  
•Latency Threshold  
•Fail Threshold  
•Target 1  
•Target 2]
    CheckParams --> CheckIGMP{IGMP Enable?  
WAN IP Alias?}
    CheckIGMP -- Enable --> End
    
```

▶ Connection Control	Auto-reconnect ▼
▶ MTU Setup	<input type="checkbox"/> Enable
▶ NAT	<input checked="" type="checkbox"/> Enable
▶ IGMP	Disable ▼
▶ WAN IP Alias	<input type="checkbox"/> Enable 10.0.0.1

Network Monitoring Configuration	
Item	Setting
▶ Network Monitoring Configuration	<input checked="" type="checkbox"/> Enable
▶ Checking Method	DNS Query ▼
▶ Loading Check	<input checked="" type="checkbox"/> Enable
▶ Query Interval	5 (seconds)
▶ Latency Threshold	3000 (ms)
▶ Fail Threshold	5 (Times)
▶ Target1	DNS1 ▼
▶ Target2	None ▼

There are some important parameters to be setup no matter which Ethernet WAN type is selected. You should follow up the rule to configure.

Connection Control.

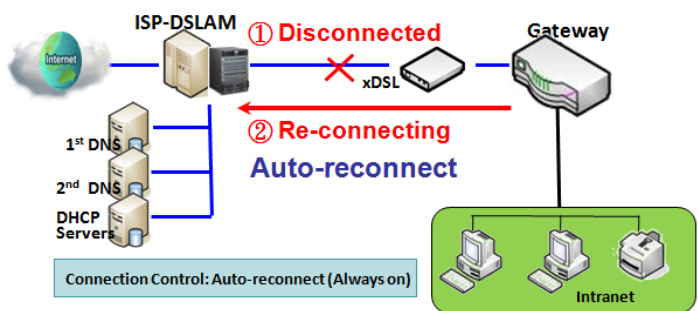

Auto-reconnect: This gateway will establish Internet connection automatically once it has been booted up, and try to reconnect once the connection is down. It's recommended to choose this scheme if for mission critical applications to ensure full-time Internet connection.

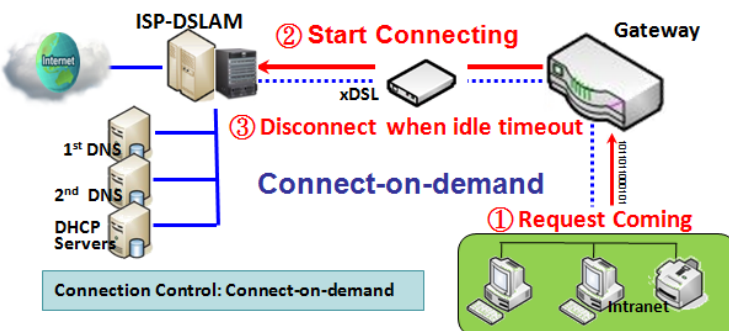

Connect-on-demand: This gateway won't start to establish Internet connection until local data is going to be sent to WAN side. After normal data transferring between LAN and WAN sides, this gateway will disconnect WAN connection if idle time reaches value of Maximum Idle Time.

4G Vehicle Gateway

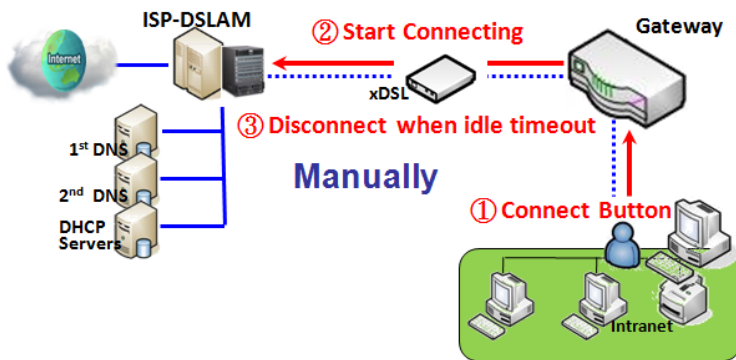

Manually: This gateway won't start to establish WAN connection until you press "Connect" button on web UI. After normal data transferring between LAN and WAN sides, this gateway will disconnect WAN connection if idle time reaches value of Maximum Idle Time.

Please be noted, if the WAN interface serves as the primary one for another WAN interface in Failover role, the Connection Control parameter will not be available to you to configure as the system must set it to "Auto-reconnect (Always on)".

Network Monitoring

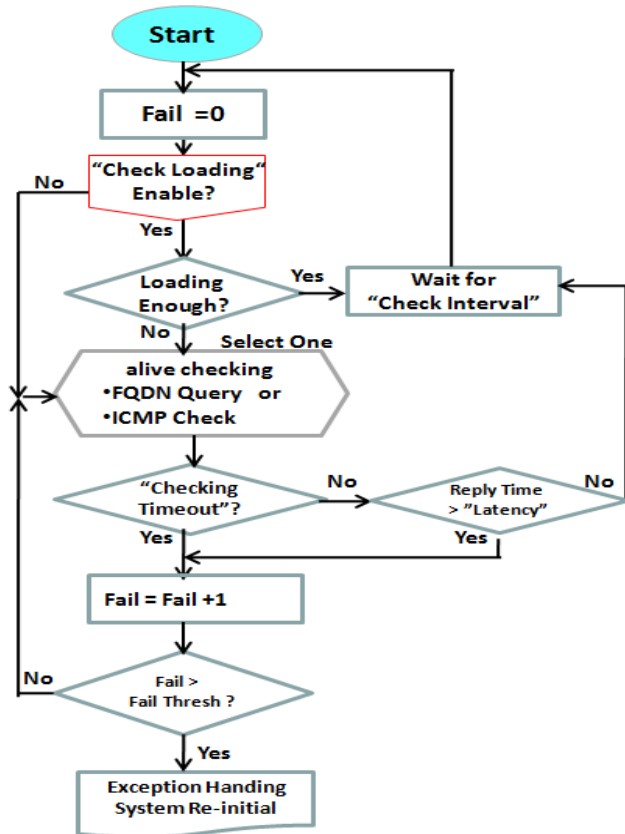

It is necessary to monitor connection status continuous. To do it, "ICMP Check" and "FQDN Query" are used to check. When there is traffic of connection, checking packet will waste bandwidth. Response time of replied packets may also increase. To avoid "Network Monitoring" work abnormally, enabling "Checking Loading" option will stop connection check when there is traffic. It will wait for another "Check Interval" and then check loading again.

When you do "Network Monitoring", if reply time longer than "Latency" or even no response longer than "Checking Timeout", "Fail" count will be increased. If it is continuous and "Fail" count is more than "Fail Threshold", gateway will do exception handling process and re-initial this connection again. Otherwise, network monitoring process will be start again.

4G Vehicle Gateway

Set up “Ethernet Common Configuration”

Ethernet WAN Common Configuration		
Item	Value setting	Description
Connection Control	A Must filled setting	<p>There are three connection modes.</p> <ul style="list-style-type: none"> • Auto-reconnect enables the router to always keep the Internet connection on. • Connect-on-demand enables the router to automatically re-establish Internet connection as soon as user attempts to access the Internet. Internet connection will be disconnected when it has been inactive for a specified idle time. • Connect Manually allows user to connect to Internet manually. Internet connection will be inactive after it has been inactive for specified idle time.
Maximum Idle Time	<ol style="list-style-type: none"> 1. An Optional setting 2. By default 600 seconds is filled-in 	<p>Specify the maximum Idle time setting to disconnect the internet connection when the connection idle timed out.</p> <p>Value Range: 300 ~ 86400.</p> <p>Note: This field is available only when Connect-on-demand or Connect Manually is selected as the connection control scheme.</p>
MTU Setup	<ol style="list-style-type: none"> 1. An Optional setting 2. Uncheck by default 	<p>Check the Enable box to enable the MTU (Maximum Transmission Unit) limit, and specify the MTU for the 3G/4G connection.</p> <p>MTU refers to Maximum Transmission Unit. It specifies the largest packet size permitted for Internet transmission.</p> <p>Value Range: 1200 ~ 1500.</p>
MTU Setup	<ol style="list-style-type: none"> 1. A Must filled setting 2. Auto (value zero) is set by default 3. Manual set range 1200~1500 	<p>MTU refers to Maximum Transmission Unit. It specifies the largest packet size permitted for Internet transmission.</p> <p>When set to Auto (value '0'), the router selects the best MTU for best Internet connection performance.</p>
NAT	<ol style="list-style-type: none"> 1. An optional setting 2. NAT is enabled by default 	<p>Enable NAT to apply NAT on the WAN connection. Uncheck the box to disable NAT function.</p>
IGMP	<ol style="list-style-type: none"> 1. A Must filled setting 2. Disable is set by default 	<p>Enable IGMP (Internet Group Management Protocol) would enable the router to listen to IGMP packets to discover which interfaces are connected to which device. The router uses the interface information generated by IGMP to reduce bandwidth consumption in a multi-access network environment to avoid flooding the entire network.</p>
WAN IP Alias	<ol style="list-style-type: none"> 1. An optional setting 2. Uncheck by default 	<p>Enable WAN IP Alias then enter the IP address provided by your service provider.</p> <p>WAN IP Alias is used by the device router and is treated as a second set of WAN IP to provide dual WAN IP address to your LAN network.</p>

4G Vehicle Gateway

Network Monitoring Configuration	
Item	Setting
▶ Network Monitoring Configuration	<input checked="" type="checkbox"/> Enable
▶ Checking Method	DNS Query ▼
▶ Loading Check	<input checked="" type="checkbox"/> Enable
▶ Query Interval	5 (seconds)
▶ Latency Threshold	3000 (ms)
▶ Fail Threshold	5 (Times)
▶ Target1	DNS1 ▼
▶ Target2	None ▼

Network Monitoring Configuration		
Item	Value setting	Description
Network Monitoring Configuration	1. An optional setting 2. Box is checked by default	Check the Enable box to activate the network monitoring function.
Checking Method	1. An Optional setting 2. DNS Query is set by default	Choose either DNS Query or ICMP Checking to detect WAN link. With DNS Query , the system checks the connection by sending DNS Query packets to the destination specified in Target 1 and Target 2. With ICMP Checking , the system will check connection by sending ICMP request packets to the destination specified in Target 1 and Target 2.
Loading Check	1. An optional setting 2. Box is checked by default	Check the Enable box to activate the loading check function. Enable Loading Check allows the gateway to ignore unreturned DNS queries or ICMP requests when WAN bandwidth is fully occupied. This is to prevent false link-down status.
Query Interval	1. An Optional setting 2. 5 seconds is selected by default.	Specify a time interval as the DNS Query Interval . Query Interval defines the transmitting interval between two DNS Query or ICMP checking packets. With DNS Query , the system checks the connection by sending DNS Query packets to the destination specified in Target 1 and Target 2. Value Range: 2 ~ 14400.
Check Interval	1. An Optional setting 2. 5 seconds is selected by default.	Specify a time interval as the ICMP Checking Interval . Query Interval defines the transmitting interval between two DNS Query or ICMP checking packets. With ICMP Checking , the system will check connection by sending ICMP request packets to the destination specified in Target 1 and Target 2. Value Range: 2 ~ 14400.
Latency Threshold	1. An Optional setting 2. 3000 ms is set by default	Enter a number of detecting disconnection times to be the threshold before disconnection is acknowledged. Latency Threshold defines the tolerance threshold of responding time. Value Range: 2000 ~ 3000 seconds.
Fail Threshold	1. An Optional setting 2. 5 times is set by default	Enter a number of detecting disconnection times to be the threshold before disconnection is acknowledged. Fail Threshold specifies the detected disconnection before the router recognize the WAN link down status.

4G Vehicle Gateway

		<u>Value Range:</u> 1 ~ 10 times.
Target 1	<ol style="list-style-type: none"> 1. An Optional filled setting 2. DNS1 is selected by default 	<p>Target1 specifies the first target of sending DNS query/ICMP request.</p> <p>DNS1: set the primary DNS to be the target.</p> <p>DNS2: set the secondary DNS to be the target.</p> <p>Gateway: set the Current gateway to be the target.</p> <p>Other Host: enter an IP address to be the target.</p>
Target 2	<ol style="list-style-type: none"> 1. An Optional filled setting 2. None is selected by default 	<p>Target1 specifies the second target of sending DNS query/ICMP request.</p> <p>None: no second target is required.</p> <p>DNS1: set the primary DNS to be the target.</p> <p>DNS2: set the secondary DNS to be the target.</p> <p>Gateway: set the Current gateway to be the target.</p> <p>Other Host: enter an IP address to be the target.</p>
Save	N/A	Click Save to save the settings.
Undo	N/A	Click Undo to cancel the settings.

4G Vehicle Gateway

Internet Connection – 3G/4G WAN

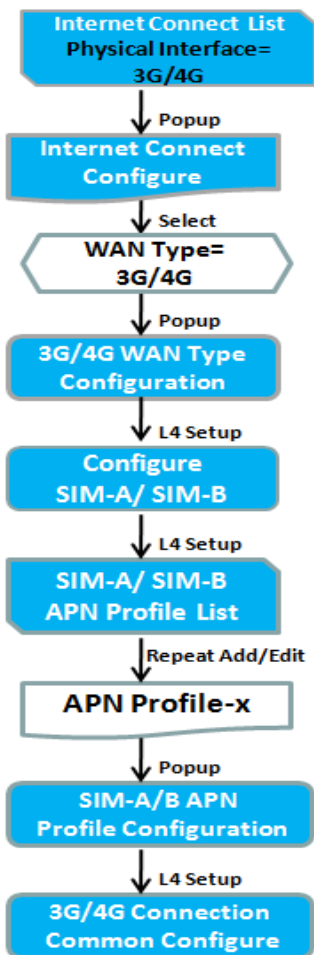

Internet Connection Configuration (WAN - 2)	
Item	Setting
▶ WAN Type	3G/4G ▼
3G/4G WAN Type Configuration	
Item	Setting
▶ Preferred SIM Card	SIM-A First ▼ Failback : <input type="checkbox"/> Enable
▶ Auto Flight Mode	<input type="checkbox"/> Enable
▶ SIM Switch Policy	Policy Setting
Connection with SIM-A Card	
Connection with SIM-B Card	
3G/4G Connection Common Configuration	
Item	Setting
▶ Connection Control	Auto-reconnect ▼
▶ Time Schedule	(0) Always ▼
▶ MTU Setup	<input type="checkbox"/> Enable

Preferred SIM Card – Dual SIM Fail Over

For 3G/4G embedded device, one embedded cellular module can create only one WAN interface. This device has featured by using dual SIM cards for one module with special fail-over mechanism. It is called Dual SIM Failover. This feature is useful for ISP switch over when location is changed. Within “Dual SIM Failover”, there are various usage scenarios, including "SIM-A First", "SIM-B First“ with “Failback” enabled or not, and “SIM-A Only and “SIM-B Only”.

4G Vehicle Gateway

SIM-A/SIM-B only: When “SIM-A Only” or “SIM-B Only” is used, the specified SIM slot card is the only one to be used for negotiation parameters between gateway device and cellular ISP.

SIM-A / SIM-B first without enable Failback

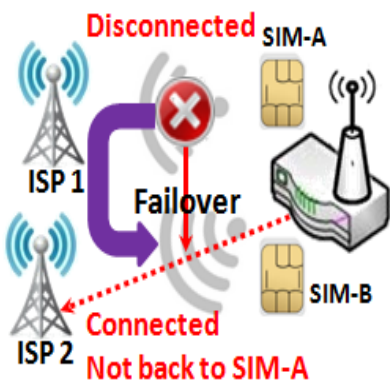

By default, “SIM-A First” scenario is used to connect to cellular ISP for data transfer. In the case of “SIM-A First” or “SIM-B First” scenario, the gateway will try to connect to the Internet by using SIM-A or SIM-B card first. And when the connection is broken, the gateway will switch to use the other SIM card for an alternate automatically and **will not switch back** to use original SIM card except current SIM connection is also broken. That is, SIM-A and SIM-B are used iteratively, but either one will keep being used for data transfer when current connection is still alive.

SIM-A / SIM-B first with Failback enable

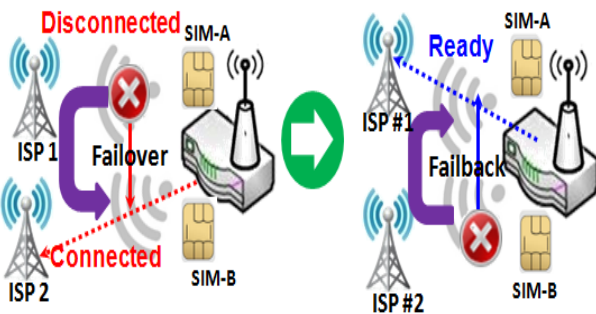

With Failback option enabled, “SIM-A First” scenario is used to connect when the connection is broken, gateway system will switch to use SIM-B. And when SIM-A connection is recovered, it will switch back to use original SIM-A card

4G Vehicle Gateway

Configure 3G/4G WAN Setting

When **Edit** button is applied, **Internet Connection Configuration**, and **3G/4G WAN Configuration** screens will appear.

Internet Connection Configuration (WAN - 2)	
Item	Setting
▶ WAN Type	3G/4G ▼

3G/4G WAN Type Configuration	
Item	Setting
▶ Preferred SIM Card	SIM-A First ▼ Failback : <input type="checkbox"/> Enable
▶ Auto Flight Mode	<input type="checkbox"/> Enable
▶ SIM Switch Policy	Policy Setting

3G/4G Connection Configuration		
Item	Value setting	Description
WAN Type	<ol style="list-style-type: none"> 1. A Must filled setting 2. 3G/4G is set by default. 	From the dropdown box, select Internet connection method for 3G/4G WAN Connection. Only 3G/4G is available.
Preferred SIM Card	<ol style="list-style-type: none"> 1. A Must filled setting 2. By default SIM-A First is selected 3. Failback is unchecked by default 	<p>Choose which SIM card you want to use for the connection.</p> <p>When SIM-A First or SIM-B First is selected, it means the connection is built first by using SIM A/SIM B. And if the connection is failed, it will change to the other SIM card and try to dial again, until the connection is up.</p> <p>When SIM-A only or SIM-B only is selected, it will try to dial up only using the SIM card you selected.</p> <p>When Failback is checked, it means if the connection is dialed-up not using the main SIM you selected, it will failback to the main SIM and try to establish the connection periodically.</p> <p>Note_1: For the product with single SIM design, only SIM-A Only option is available.</p> <p>Note_2: Failback is available only when SIM-A First or SIM-B First is selected.</p>
Auto Flight Mode	The box is unchecked by default	<p>Check the Enable box to activate the function.</p> <p>By default, if you disabled the Auto Flight Mode, the cellular module will always occupy a physical channel with cellular tower. It can get data connection instantly, and receive managing SMS all the time on required.</p> <p>If you enabled the Auto Flight Mode, the gateway will pop up a message <i>"Flight mode will cause cellular function to be malfunctioned when the data session is offline."</i>, and it will make the cellular module into flight mode and disconnected with cellular tower physically. In addition, whenever the cellular module is going to be used for data connection to backup the failed primary connection, the cellular module will be active to connect with cellular tower and get the data connection for use, It takes few more seconds.</p>

4G Vehicle Gateway

		Note: Keep it unchecked unless your cellular ISP asked the connected gateway to enable the Auto Flight Mode.
SIM Switch Policy	NA	Click the Policy Setting button to define the SIM Switch policy or browse the current policy settings.

Policy Setting	
Item	Setting
▶ Failed connection	<input type="text" value="0"/> (1-10) times
▶ RSSI Monitor	<input type="checkbox"/> Enable Threshold: - <input type="text" value="0"/> (-90~-113 dBm)
▶ Network Service	<input type="checkbox"/> Enable Loss LTE signal: <input type="text" value="0"/> (1~30 minutes)
▶ Roaming Service	<input type="checkbox"/> Enable Timeout: <input type="text" value="0"/> (1~30 minutes)

Configure SIM-A / SIM-B Card

Here you can set configurations for the cellular connection according to your situation or requirement.

Connection with SIM-A Card	
Item	Setting
▶ Network Type	<input type="text" value="Auto"/>
▶ Dial-Up Profile	<input type="text" value="Manual-configuration"/>
▶ APN	<input type="text"/>
▶ IP Type	<input type="text" value="IPv4"/>
▶ PIN Code	<input type="text"/> (Optional)
▶ Dial Number	<input type="text"/> (Optional)
▶ Account	<input type="text"/> (Optional)
▶ Password	<input type="text"/> (Optional) <input type="checkbox"/>
▶ Authentication	<input type="text" value="Auto"/>
▶ IP Mode	<input type="text" value="Dynamic IP"/>
▶ Primary DNS	<input type="text"/> (Optional)
▶ Secondary DNS	<input type="text"/> (Optional)
▶ Roaming	<input type="checkbox"/> Enable

Note_1: Configurations of SIM-B Card follows the same rule of Configurations of SIM-A Card, here we list SIM-A as the example.

Note_2: Both **Connection with SIM-A Card** and **Connection with SIM-B Card** will pop up only when the **SIM-A First** or **SIM-B First** is selected, otherwise it only pops out one of them.

4G Vehicle Gateway

Connection with SIM-A/-B Card		
Item	Value setting	Description
Network Type	<ol style="list-style-type: none"> 1. A Must filled setting 2. By default Auto is selected 	<p>Select Auto to register a network automatically, regardless of the network type.</p> <p>Select 2G Only to register the 2G network only.</p> <p>Select 2G Prefer to register the 2G network first if it is available.</p> <p>Select 3G only to register the 3G network only.</p> <p>Select 3G Prefer to register the 3G network first if it is available.</p> <p>Select LTE only to register the LTE network only.</p> <p>Note: Options may be different due to the specification of the module.</p>
Dial-Up Profile	<ol style="list-style-type: none"> 1. A Must filled setting 2. By default Manual-configuration is selected 	<p>Specify the type of dial-up profile for your 3G/4G network. It can be Manual-configuration, APN Profile List, or Auto-detection.</p> <p>Select Manual-configuration to set APN (Access Point Name), Dial Number, Account, and Password to what your carrier provides.</p> <p>Select APN Profile List to set more than one profile to dial up in turn, until the connection is established. It will pop up a new filed, please go to Basic Network > WAN & Uplink > Internet Setup > SIM-A APN Profile List for details.</p> <p>Select Auto-detection to automatically bring out all configurations needed while dialing-up, by comparing the IMSI of the SIM card to the record listed in the manufacturer's database.</p> <p>Note_1: You are highly recommended to select the Manual or APN Profile List to specify the network for your subscription. Your ISP always provides such network settings for the subscribers.</p> <p>Note_2: If you select Auto-detection, it is likely to connect to improper network, or failed to find a valid APN for your ISP.</p>
APN	<ol style="list-style-type: none"> 1. A Must filled setting 2. String format : any text 	<p>Enter the APN you want to use to establish the connection.</p> <p>This is a must-filled setting if you selected Manual-configuration as dial-up profile scheme.</p>
IP Type	<ol style="list-style-type: none"> 1. A Must filled setting 2. By default IPv4 is selected 	<p>Specify the IP type of the network service provided by your 3G/4G network. It can be IPv4, IPv6, or IPv4/6.</p>
PIN code	<ol style="list-style-type: none"> 1. An Optional setting 2. String format : interger 	<p>Enter the PIN (Personal Identification Number) code if it needs to unlock your SIM card.</p>
Dial Number, Account, Password	<ol style="list-style-type: none"> 1. An Optional setting 2. String format : any text 	<p>Enter the optional Dial Number, Account, and Password settings if your ISP provided such settings to you.</p> <p>Note: These settings are only displayed when Manual-configuration is selected.</p>
Authentication	<ol style="list-style-type: none"> 1. A Must filled setting 2. By default Auto is selected 	<p>Select PAP (Password Authentication Protocol) and use such protocol to be authenticated with the carrier's server.</p> <p>Select CHAP (Challenge Handshake Authentication Protocol) and use such protocol to be authenticated with the carrier's server.</p> <p>When Auto is selected, it means it will authenticate with the server either PAP or CHAP.</p>
IP Mode	<ol style="list-style-type: none"> 1. A Must filled setting 2. By default Dynamic IP is selected 	<p>When Dynamic IP is selected, it means it will get all IP configurations from the carrier's server and set to the device directly.</p> <p>If you have specific application provided by the carrier, and want to set IP configurations on your own, you can switch to Static IP mode and fill in all</p>

4G Vehicle Gateway

		parameters that required, such as IP address, subnet mask and gateway. Note: IP Subnet Mask is a must filled setting, and make sure you have the right configuration. Otherwise, the connection may get issues.
Primary DNS	1. An Optional setting 2. String format : IP address (IPv4 type)	Enter the IP address to change the primary DNS (Domain Name Server) setting. If it is not filled-in, the server address is given by the carrier while dialing-up.
Secondary DNS	1. An Optional setting 2. String format : IP address (IPv4 type)	Enter the IP address to change the secondary DNS (Domain Name Server) setting. If it is not filled-in, the server address is given by the carrier while dialing-up.
Roaming	The box is unchecked by default	Check the box to establish the connection even the registration status is roaming, not in home network. Note: It may cost additional charges if the connection is under roaming.

Create/Edit SIM-A / SIM-B APN Profile List

You can add a new APN profile for the connection, or modify the content of the APN profile you added. It is available only when you select **Dial-Up Profile** as **APN Profile List**.

SIM-A APN Profile List Add Delete									
ID	Profile Name	APN	IP Type	Account	Password	Authentication	Priority	Enable	Actions

List all the APN profile you created, easily for you to check and modify. It is available only when you select **Dial-Up Profile** as **APN Profile List**.

When **Add** button is applied, an **APN Profile Configuration** screen will appear.

SIM-A APN Profile Configuration	
Item	Setting
▶ Profile Name	<input type="text" value="Profile-1"/>
▶ APN	<input type="text"/>
▶ IP Type	IPv4 ▼
▶ Account	<input type="text"/> (Optional)
▶ Password	<input type="password"/>  (Optional)
▶ Authentication	Auto ▼
▶ Priority	<input type="text"/>
▶ Profile	<input type="checkbox"/> Enable

SIM-A/-B APN Profile Configuration		
Item	Value setting	Description
Profile Name	1. By default Profile-x is listed 2. String format : any text	Enter the profile name you want to describe for this profile.
APN	String format : any text	Enter the APN you want to use to establish the connection.

4G Vehicle Gateway

IP Type	1. A Must filled setting 2. By default IPv4 is selected	Specify the IP type of the network service provided by your 3G/4G network. It can be IPv4 , IPv6 , or IPv4/6 .
Account	String format : any text	Enter the Account you want to use for the authentication. Value Range: 0 ~ 53 characters.
Password	String format : any text	Enter the Password you want to use for the authentication.
Authentication	1. A Must filled setting 2. By default Auto is selected	Select the Authentication method for the 3G/4G connection. It can be Auto , PAP , CHAP , or None .
Priority	1. A Must filled setting 2. String format : integer	Enter the value for the dialing-up order. The valid value is from 1 to 16. It will start to dial up with the profile that assigned with the smallest number. Value Range: 1 ~ 16.
Profile	The box is checked by default	Check the box to enable this profile. Uncheck the box to disable this profile in dialing-up action.
Save	N/A	Click the Save button to save the configuration.
Undo	N/A	Click the X button to restore what you just configured back to the previous setting.

Setup 3G/4G Connection Common Configuration

Here you can change common configurations for 3G/4G WAN.

3G/4G Connection Common Configuration	
Item	Setting
▶ Connection Control	Auto-reconnect ▼
▶ Time Schedule	(0) Always ▼
▶ MTU Setup	<input type="checkbox"/> Enable
▶ IP Passthrough (Cellular Bridge)	<input type="checkbox"/> Enable Fixed MAC : <input type="text"/>
▶ NAT	<input checked="" type="checkbox"/> Enable
▶ IGMP	Disable ▼
▶ WAN IP Alias	<input type="checkbox"/> Enable <input type="text" value="10.0.0.1"/>

3G/4G Connection Common Configuration		
Item	Value setting	Description
Connection Control	By default Auto-reconnect is selected	<p>When Auto-reconnect is selected, it means it will try to keep the Internet connection on all the time whenever the physical link is connected.</p> <p>When Connect-on-demand is selected, it means the Internet connection will be established only when detecting data traffic.</p> <p>When Connect Manually is selected, it means you need to click the Connect button to dial up the connection manually. Please go to Status > Basic Network > WAN & Uplink tab for details.</p> <p>Note: If the WAN interface serves as the primary one for another WAN</p>

4G Vehicle Gateway

		interface in Failover role(and vice versa), the Connection Control parameter will not be available on both WANs as the system must set it to "Auto-reconnect"
Maximum Idle Time	<ol style="list-style-type: none"> 1. An Optional setting 2. By default 600 seconds is filled-in 	<p>Specify the maximum Idle time setting to disconnect the internet connection when the connection idle timed out.</p> <p>Value Range: 300 ~ 86400.</p> <p>Note: This field is available only when Connect-on-demand or Connect Manually is selected as the connection control scheme.</p>
Time Schedule	<ol style="list-style-type: none"> 1. A Must filled setting 2. By default (0) Always is selected 	<p>When (0) Always is selected, it means this WAN is under operation all the time. Once you have set other schedule rules, there will be other options to select. Please go to Object Definition > Scheduling for details.</p>
MTU Setup	<ol style="list-style-type: none"> 1. An Optional setting 2. Uncheck by default 	<p>Check the Enable box to enable the MTU (Maximum Transmission Unit) limit, and specify the MTU for the 3G/4G connection.</p> <p>MTU refers to Maximum Transmission Unit. It specifies the largest packet size permitted for Internet transmission.</p> <p>Value Range: 1200 ~ 1500.</p>
IP Pass-through (Cellular Bridge)	<ol style="list-style-type: none"> 1. The box is unchecked by default 2. String format for Fixed MAC: MAC address, e.g. 00:50:18:aa:bb:cc 	<p>When Enable box is checked, it means the device will directly assign the WAN IP to the first connected local LAN client.</p> <p>However, when an optional Fixed MAC is filled-in a non-zero value, it means only the client with this MAC address can get the WAN IP address.</p> <p>Note: When the IP Pass-through is on, NAT and WAN IP Alias will be unavailable until the function is disabled again.</p>
NAT	Check by default	Uncheck the box to disable NAT (Network Address Translation) function.
IGMP	By default Disable is selected	Select Auto to enable IGMP function. Check the Enable box to enable IGMP Proxy .
WAN IP Alias	<ol style="list-style-type: none"> 1. Unchecked by default 2. String format: IP address (IPv4 type) 	Check the box to enable WAN IP Alias , and fill in the IP address you want to assign.

Network Monitoring Configuration	
Item	Setting
▶ Network Monitoring Configuration	<input checked="" type="checkbox"/> Enable
▶ Checking Method	DNS Query ▼
▶ Loading Check	<input checked="" type="checkbox"/> Enable
▶ Query Interval	5 (seconds)
▶ Latency Threshold	3000 (ms)
▶ Fail Threshold	5 (Times)
▶ Target1	DNS1 ▼
▶ Target2	None ▼

Network Monitoring Configuration Item	Value setting	Description
---------------------------------------	---------------	-------------

4G Vehicle Gateway

Network Monitoring Configuration	<ol style="list-style-type: none"> 1. An optional setting 2. Box is checked by default 	Check the Enable box to activate the network monitoring function.
Checking Method	<ol style="list-style-type: none"> 1. An Optional setting 2. DNS Query is set by default 	<p>Choose either DNS Query or ICMP Checking to detect WAN link.</p> <p>With DNS Query, the system checks the connection by sending DNS Query packets to the destination specified in Target 1 and Target 2.</p> <p>With ICMP Checking, the system will check connection by sending ICMP request packets to the destination specified in Target 1 and Target 2.</p>
Loading Check	<ol style="list-style-type: none"> 1. An optional setting 2. Box is checked by default 	<p>Check the Enable box to activate the loading check function.</p> <p>Enable Loading Check allows the gateway to ignore unreturned DNS queries or ICMP requests when WAN bandwidth is fully occupied. This is to prevent false link-down status.</p>
Query Interval	<ol style="list-style-type: none"> 1. An Optional setting 2. 5 seconds is selected by default. 	<p>Specify a time interval as the DNS Query Interval.</p> <p>Query Interval defines the transmitting interval between two DNS Query or ICMP checking packets.</p> <p>With DNS Query, the system checks the connection by sending DNS Query packets to the destination specified in Target 1 and Target 2.</p> <p>Value Range: 2 ~ 14400.</p>
Check Interval	<ol style="list-style-type: none"> 1. An Optional setting 2. 5 seconds is selected by default. 	<p>Specify a time interval as the ICMP Checking Interval.</p> <p>Query Interval defines the transmitting interval between two DNS Query or ICMP checking packets.</p> <p>With ICMP Checking, the system will check connection by sending ICMP request packets to the destination specified in Target 1 and Target 2.</p> <p>Value Range: 2 ~ 14400.</p>
Latency Threshold	<ol style="list-style-type: none"> 1. An Optional setting 2. 3000 ms is set by default 	<p>Enter a number of detecting disconnection times to be the threshold before disconnection is acknowledged.</p> <p>Latency Threshold defines the tolerance threshold of responding time.</p> <p>Value Range: 2000 ~ 3000 seconds.</p>
Fail Threshold	<ol style="list-style-type: none"> 1. An Optional setting 2. 5 times is set by default 	<p>Enter a number of detecting disconnection times to be the threshold before disconnection is acknowledged.</p> <p>Fail Threshold specifies the detected disconnection before the router recognize the WAN link down status.</p> <p>Value Range: 1 ~ 10 times.</p>
Target 1	<ol style="list-style-type: none"> 1. An Optional filled setting 2. DNS1 is selected by default 	<p>Target1 specifies the first target of sending DNS query/ICMP request.</p> <p>DNS1: set the primary DNS to be the target.</p> <p>DNS2: set the secondary DNS to be the target.</p> <p>Gateway: set the Current gateway to be the target.</p> <p>Other Host: enter an IP address to be the target.</p>
Target 2	<ol style="list-style-type: none"> 1. An Optional filled setting 2. None is selected by default 	<p>Target1 specifies the second target of sending DNS query/ICMP request.</p> <p>None: no second target is required.</p> <p>DNS1: set the primary DNS to be the target.</p> <p>DNS2: set the secondary DNS to be the target.</p> <p>Gateway: set the Current gateway to be the target.</p> <p>Other Host: enter an IP address to be the target.</p>
Save	N/A	Click Save to save the settings.
Undo	N/A	Click Undo to cancel the settings.

4G Vehicle Gateway

2.1.3 Load Balance

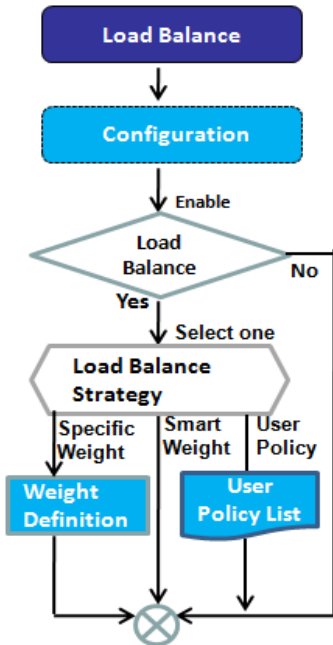

Item	Setting
Load Balance	<input checked="" type="checkbox"/> Enable
Load Balance Strategy	By Specific Weight ▾
Weight Definition	By Specific Weight
WAN ID	Weight
WAN - 1	86 %
WAN - 2	13 %
	Action
	Edit
	Edit

ID	Source IP Address	Destination IP Address	Destination Port	WAN Interface	Enable	Actions
User Policy Configuration						

When there are multiple WAN interfaces, and when the bandwidth of one WAN connection is not enough for the traffic loads from the Intranet to the Internet, the WAN load balance function can be considered to enlarge the total WAN bandwidth.

Load Balance Strategy

There are three optional strategies for load balance: **“By Smart Weight”**, **“By Specific Weight”**, and **“By User Policy”**. Administrator can select strategy according to application requirement and environment status. The strategies are explained as below.

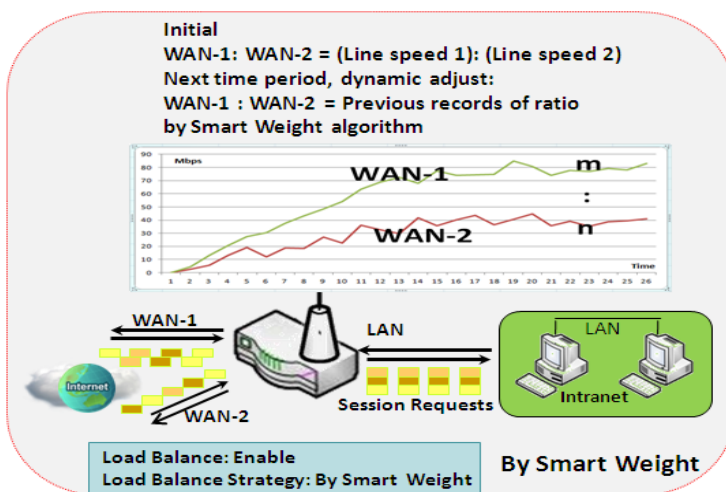

By Smart Weight

If based on "By Smart Weight" strategy, gateway will take the line speed settings of all WAN interfaces specified in "Physical Interface" configuration page as default ratio for data transfer. Based on the ratio of packet bytes via these WAN interfaces in past period (maybe 5 minutes), system decides how many sessions will be transferred via each WAN interface for next period. Administrator may take it as a fast approach to maximize the bandwidth utilization of multiple WAN interfaces in gateway

4G Vehicle Gateway

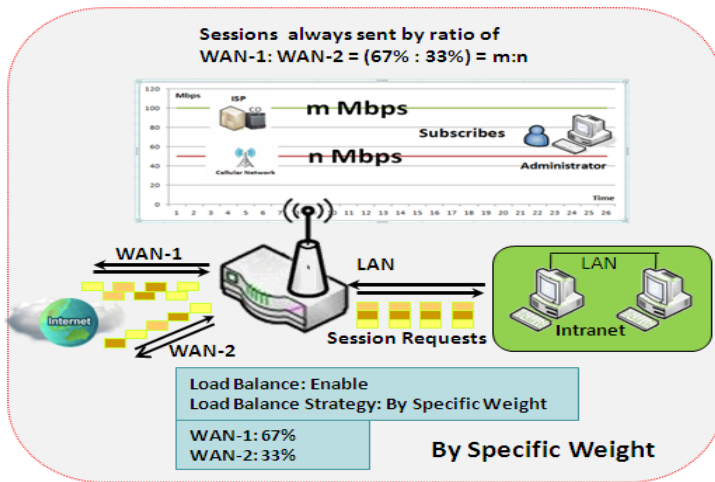

By Specific Weight

When you select "By Specific Weight", you need to set up ratio of WAN-1/WAN-2 to decide sessions sent ratio. Total ratio should be 100%. Ratio is usually defined based on practical WAN speed of environment. Gateway's traffic control process will operate routing adequately based on the dedicated weights ratio on all WAN interfaces.

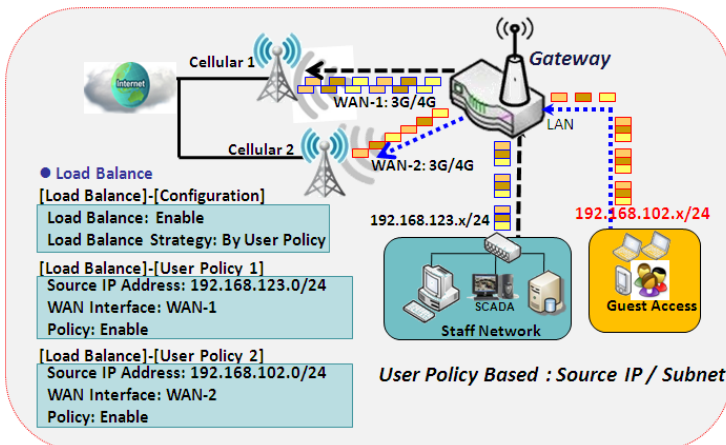

By User Policy

If "By User Policy" load balance strategy is selected, it can allow you to mapping Source IP, Destination IP, or Destination Port to assigned WAN interface. This IP address is not only a single IP but also a subnet or IP range. Destination port can be a single port or port range. You can select one target for one mapping to setup IP address and leave others just left as "any" / "All". Besides this, you can also set protocol as TCP, UDP or both.

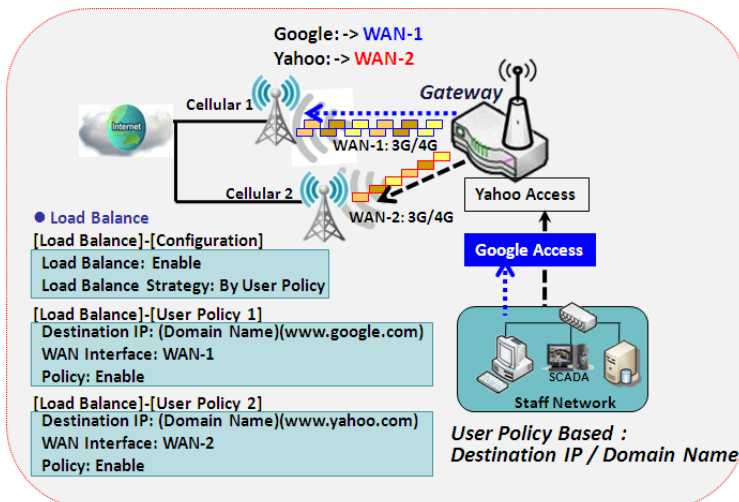

Diagrams shown on left side are examples user policy. The first diagram illustrates example for mapping various source IP subnets to different WAN interface. All packets from different subnet will be routed to the assigned WAN interface. Administrator can manage and balance the loading among available WAN interfaces accordingly.

The second diagram illustrates another example for routing packets with designated destination IP or domain name to a certain WAN interface. If packets do not belong to user policy rule, the gateway just routes those packets based on smart weight algorithm.

4G Vehicle Gateway

Load Balance Setting

Go to **Basic Network > WAN & Uplink > Load Balance** Tab.

The **Load Balance** function is used to manage balance bandwidth usage among multiple WAN connections. When you choose "By Smart Weight" strategy, system will operate load balance function automatically based on the embedded Smart Weight algorithm. However, when you choose "By Specific Weight" strategy, the further "Weight Definition" configuration window will let you define the ratio of transferred sessions between all WAN interfaces for data transfer. At last, when you choose "By User Policy" strategy, the further "User Policy List" shows all defined user policy entries, and the "User Policy Configuration" window will let you create and define one user policy for routing dedicated packet flow via one WAN interface.

Enable/Select Load Balance Strategy

Configuration	
Item	Setting
▶ Load Balance	<input type="checkbox"/> Enable
▶ Load Balance Strategy	By Specific Weight ▼

Configuration		
Item	Value setting	Description
Load Balance	Unchecked by default	Check the Enable box to activate Load Balance function.
Load Balance Strategy	1. A Must filled setting 2. By Smart Weight is selected by default.	There are up to three load balance strategies. Select the preferred one. By Smart Weight: System will operate load balance function automatically based on the embedded Smart Weight algorithm. By Specific Weight: System will adjust the ratio of transferred sessions among all WANs based on the specified weights for each WAN. By User Policy: System will route traffics through available WAN interface based on user defined rules. Note: The number of available strategies depends on the model you purchased.
Save	NA	Click the Save button to save the configuration
Undo	NA	Click the Undo button to restore what you just configured back to the previous setting.

When **By Specific Weight** is selected, user needs to adjust the percentage of WAN loading. System will give a value according to the bandwidth ratio of each WAN at first time and keep the value after clicking **Save** button.

4G Vehicle Gateway

Weight Definition		
WAN ID	Weight	Action
WAN - 1	86 %	<input type="button" value="Edit"/>
WAN - 2	13 %	<input type="button" value="Edit"/>

Weight Definition		
Item	Value setting	Description
WAN ID	NA	The Identifier for each available WAN interface..
Weight	1. A Must filled setting 2. Set with bandwidth ratio of each WAN by default.	Enter the weight ratio for each WAN interface. Initially, the bandwidth ratio of each WAN is set by default. Value Range: 1 ~ 99. Note: The sum of all weights can't be greater than 100%.
Save	NA	Click the Save button to save the configuration
Undo	NA	Click the Undo button to restore what you just configured back to the previous setting.

When **By User Policy** is selected, a **User Policy List** screen will appear. With properly configured your policy rules, system will route traffics through available WAN interface based on user defined rules

Create User Policy

User Policy List <input type="button" value="Add"/> <input type="button" value="Delete"/>						
ID	Source IP Address	Destination IP Address	Destination Port	WAN Interface	Enable	Actions

When **Add** button is applied, **User Policy Configuration** screen will appear.

User Policy Configuration	
Item	Setting
▶ Source IP Address	Any ▼
▶ Destination IP Address	Any ▼
▶ Destination Port	All ▼
▶ Protocol	Both ▼
▶ WAN Interface	WAN - 1 ▼
▶ Policy	<input type="checkbox"/> Enable

User Policy Configuration		
Item	Value setting	Description
Source IP Address	1. A Must filled setting 2. Any is selected by default.	There are four options can be selected : Any: No specific Source IP is provided. The traffic may come from any source Subnet: Specify the Subnet for the traffics come from the subnet. Input format

4G Vehicle Gateway

		<p>is : xxx.xxx.xxx.xxx/xx e.g. 192.168.123.0/24.</p> <p>IP Range: Specify the IP Range for the traffics come from the IPs</p> <p>Single IP: Specify a unique IP Address for the traffics come from the IP. Input format is : xxx.xxx.xxx.xxx e.g. 192.168.123.101.</p>
Destination IP Address	<ol style="list-style-type: none"> 1. A Must filled setting 2. Any is selected by default. 	<p>There are five options can be selected :</p> <p>Any: No specific destination IP is provided. The traffic may come to any destination.</p> <p>Subnet: Specify the Subnet for the traffics come to the subnet. Input format is : xxx.xxx.xxx.xxx/xx e.g. 192.168.123.0/24.</p> <p>IP Range: Specify the IP Range for the traffics come to the IPs</p> <p>Single IP: Specify a unique IP Address for the traffics come to the IP. Input format is : xxx.xxx.xxx.xxx e.g. 192.168.123.101.</p> <p>Domain Name: Specify the domain name for the traffics come to the domain</p>
Destination Port	<ol style="list-style-type: none"> 1. A Must filled setting 2. All is selected by default. 	<p>There are four options can be selected :</p> <p>All: No specific destination port is provided.</p> <p>Port Range: Specify the Destination Port Range for the traffics</p> <p>Single Port: Specify a unique destination Port for the traffics</p> <p>Well-known Applications: Select the service port of well-known application defined in dropdown list.</p>
Protocol	<ol style="list-style-type: none"> 1. A Must filled setting 2. Both is selected by default. 	<p>There are three options can be selected. They are Both, TCP, and UDP.</p>
WAN Interface	<ol style="list-style-type: none"> 1. A Must filled setting 2. WAN-1 is selected by default. 	<p>User can select the interface that traffic should go.</p> <p>Note that the WAN interface dropdown list will only show the available WAN interfaces.</p>
Policy	Unchecked by default	Check the Enable checkbox to activate the policy rule.
Save	NA	Click the Save button to save the configuration
Undo	NA	Click the Undo button to restore what you just configured back to the previous setting.

4G Vehicle Gateway

2.2 LAN & VLAN

This section provides the configuration of LAN and VLAN. VLAN is an optional feature, and it depends on the product specification of the purchased gateway.

2.2.1 Ethernet LAN

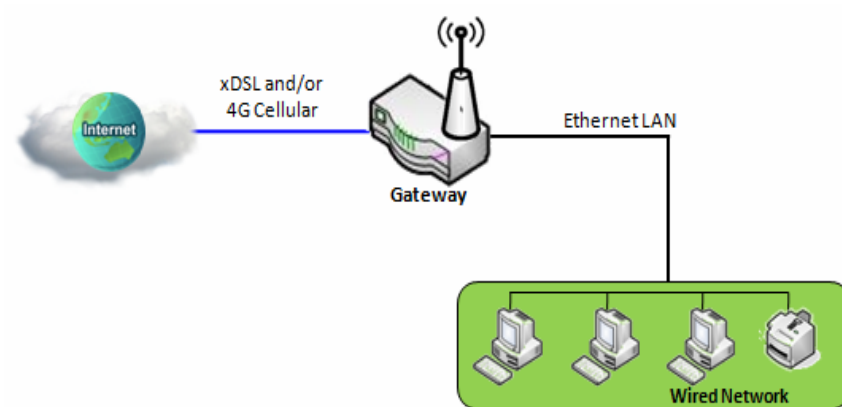

The Local Area Network (LAN) can be used to share data or files among computers attached to a network. Following diagram illustrates the network that wired and interconnects computers.

Please follow the following instructions to do IPv4 Ethernet LAN Setup.

Configuration	
Item	Setting
▶ IP Mode	Static IP
▶ LAN IP Address	<input type="text" value="192.168.123.254"/>
▶ Subnet Mask	<input type="text" value="255.255.255.0 (/24)"/> ▼

Configuration Item	Value setting	Description
IP Mode	N/A	It shows the LAN IP mode for the gateway according to the related configuration. Static IP: If there is at least one WAN interface activated, the LAN IP mode is fixed in Static IP mode. Dynamic IP: If all the available WAN interfaces are disabled, the LAN IP mode can be Dynamic IP mode.
LAN IP Address	1. A Must filled setting 2. 192.168.123.254 is set by default	Enter the local IP address of this device. The network device(s) on your network must use the LAN IP address of this device as their Default Gateway. You can change it if necessary. Note: It's also the IP address of web UI. If you change it, you need to type new IP address in the browser to see web UI.
Subnet Mask	1. A Must filled setting 2. 255.255.255.0 (/24) is set	Select the subnet mask for this gateway from the dropdown list. Subnet mask defines how many clients are allowed in one network or subnet.

4G Vehicle Gateway

	by default	The default subnet mask is 255.255.255.0 (/24), and it means maximum 254 IP addresses are allowed in this subnet. However, one of them is occupied by LAN IP address of this gateway, so there are maximum 253 clients allowed in LAN network. Value Range: 255.0.0.0 (/8) ~ 255.255.255.252 (/30).
Save	N/A	Click the Save button to save the configuration
Undo	N/A	Click the Undo button to restore what you just configured back to the previous setting.

Create / Edit Additional IP

This gateway provides the LAN IP alias function for some special management consideration. You can add additional LAN IP for this gateway, and access to this gateway with the additional IP.

Additional IP
Add
Delete
▲
✕

ID	Name	Interface	IP Address	Subnet Mask	Enable	Action
----	------	-----------	------------	-------------	--------	--------

When **Add** button is applied, **Additional IP Configuration** screen will appear.

Additional IP Configuration
▲
✕

Item	Setting
▶ Name	<input type="text"/>
▶ Interface	lo ▼
▶ IP Address	<input type="text"/>
▶ Subnet Mask	255.255.255.0 (/24) ▼
▶ Enable	<input type="checkbox"/>

Configuration Item	Value setting	Description
Name	.1 An Optional Setting	Enter the name for the alias IP address.
Interface	1. A Must filled setting 2. lo is set by default	Specify the Interface type. It can be lo or br0 .
IP Address	1. An Optional setting 2. 192.168.123.254 is set by default	Enter the addition IP address for this device.
Subnet Mask	1. A Must filled setting 2. 255.255.255.0 (/24) is set by default	Select the subnet mask for this gateway from the dropdown list. Subnet mask defines how many clients are allowed in one network or subnet. The default subnet mask is 255.255.255.0 (/24), and it means maximum 254 IP addresses are allowed in this subnet. However, one of them is occupied by LAN IP address of this gateway, so there are maximum 253 clients allowed in LAN

4G Vehicle Gateway

		network. <i>Value Range:</i> 255.0.0.0 (/8) ~ 255.255.255.255 (/32).
Save	NA	Click the Save button to save the configuration

4G Vehicle Gateway

2.2.2 VLAN

VLAN (Virtual LAN) is a logical network under a certain switch or router device to group client hosts with a specific VLAN ID. This gateway supports both Port-based VLAN and Tag-based VLAN. These functions allow you to divide local network into different “virtual LANs”. It is common requirement for some application scenario. For example, there are various departments within SMB. All client hosts in the same department should own common access privilege and QoS property. You can assign departments either by port-based VLAN or tag-based VLAN as a group, and then configure it by your plan. In some cases, ISP may need router to support “VLAN tag” for certain kinds of services (e.g. IPTV). You can group all devices required this service as one tag-based VLAN.

If the gateway has only one physical Ethernet LAN port, only very limited configuration is available if you enable the Port-based VLAN.

➤ Port-based VLAN

Port-based VLAN function can group Ethernet ports, Port-1 ~ Port-4, and WiFi Virtual Access Points, VAP-1 ~ VAP-8, together for differentiated services like Internet surfing, multimedia enjoyment, VoIP talking, and so on. Two operation modes, NAT and Bridge, can be applied to each VLAN group. One DHCP server can be allocated for a NAT VLAN group to let group host member get its IP address. Thus, each host can surf Internet via the NAT mechanism of business access gateway. In bridge mode, Intranet packet flow is delivered out WAN trunk port with VLAN tag to upper link for different services.

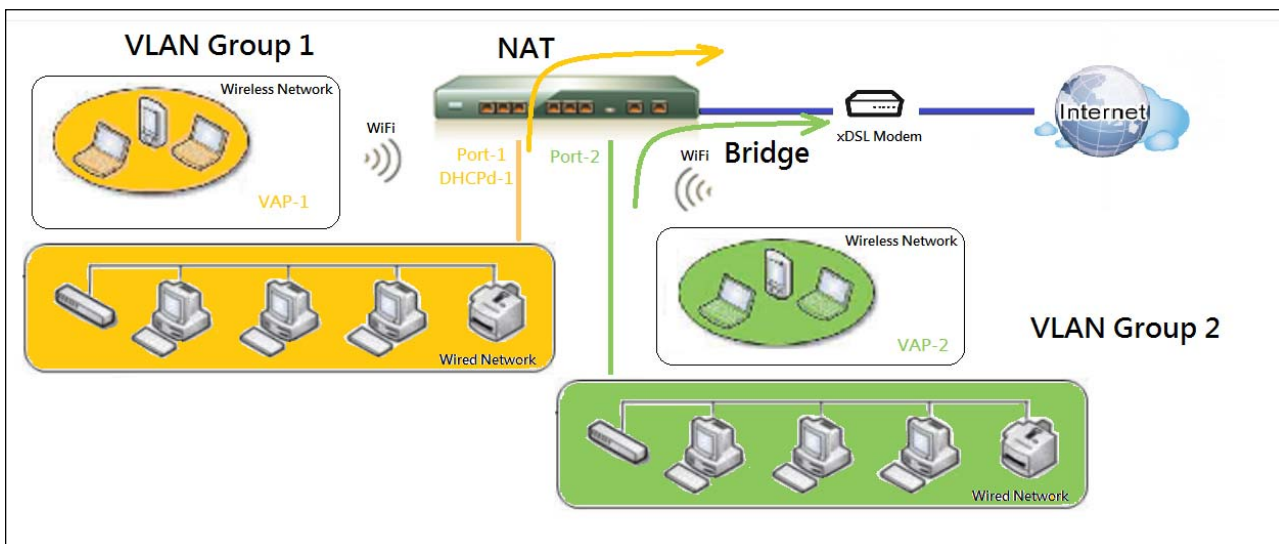

A port-based VLAN is a group of ports on an Ethernet or Virtual APs of Wired or Wireless Gateway that form a logical LAN segment. Following is an example.

For example, in a company, administrator schemes out 3 network segments, Lobby/Meeting Room, Office, and Data Center. In a Wireless Gateway, administrator can configure Lobby/Meeting Room segment with VLAN ID 3. The VLAN group includes Port-3 and VAP-8 (SSID: Guest) with NAT mode and DHCP-3 server equipped. He also configure Office segment with VLAN ID 2. The VLAN group includes Port-2 and VAP-1 (SSID:

4G Vehicle Gateway

Staff) with NAT mode and DHCP-2 server equipped. At last, administrator also configure Data Center segment with VLAN ID 1. The VLAN group includes Port-1 with NAT mode to WAN interface as shown in following diagram.

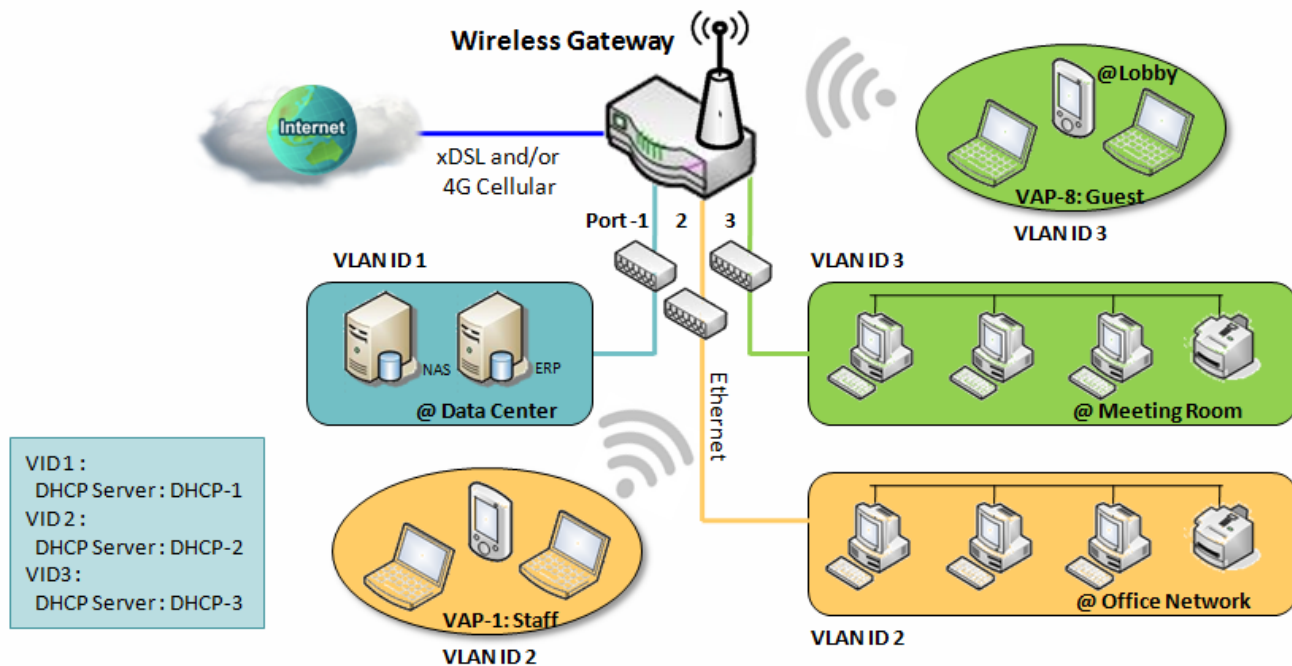

Above is the general case for 3 Ethernet LAN ports in the gateway. But if the device just has one Ethernet LAN port, there will be only one VLAN group for the device. Under such situation, it still supports both the NAT and Bridge mode for the Port-based VLAN configuration.

➤ Tag-based VLAN

Tag-based VLAN function can group Ethernet ports, Port-1 ~ Port-4, and WiFi Virtual Access Points, VAP-1 ~ VAP-8, together with different VLAN tags for deploying subnets in Intranet. All packet flows can carry with different VLAN tags even at the same physical Ethernet port for Intranet. These flows can be directed to different destination because they have differentiated tags. The approach is very useful to group some hosts at different geographic location to be in the same workgroup.

Tag-based VLAN is also called a VLAN Trunk. The VLAN Trunk collects all packet flows with different VLAN IDs from Router device and delivers them in the Intranet. VLAN membership in a tagged VLAN is determined by VLAN ID information within the packet frames that are received on a port. Administrator can further use a VLAN switch to separate the VLAN trunk to different groups based on VLAN ID. Following is an example.

4G Vehicle Gateway

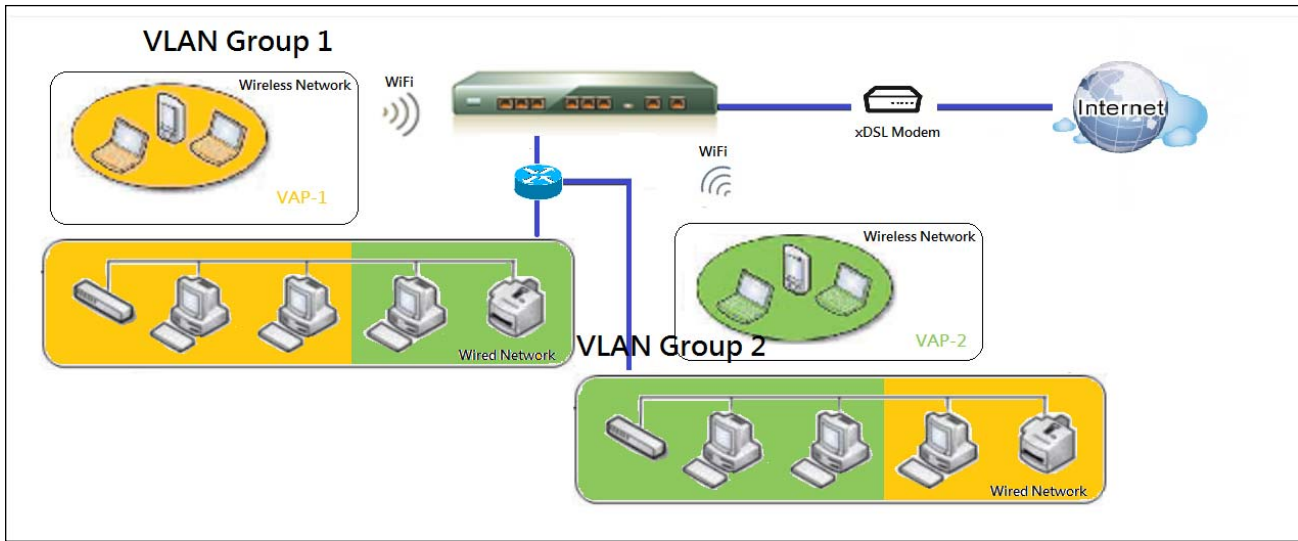

For example, in a company, administrator schemes out 3 network segments, Lab, Meeting Rooms, and Office. In a Security VPN Gateway, administrator can configure Office segment with VLAN ID 12. The VLAN group is equipped with DHCP-3 server to construct a 192.168.12.x subnet. He also configure Meeting Rooms segment with VLAN ID 11. The VLAN group is equipped with DHCP-2 server to construct a 192.168.11.x subnet for Intranet only. That is, any client host in VLAN 11 group can't access the Internet. At last, he configures Lab segment with VLAN ID 10. The VLAN group is equipped with DHCP-1 server to construct a 192.168.10.x subnet.

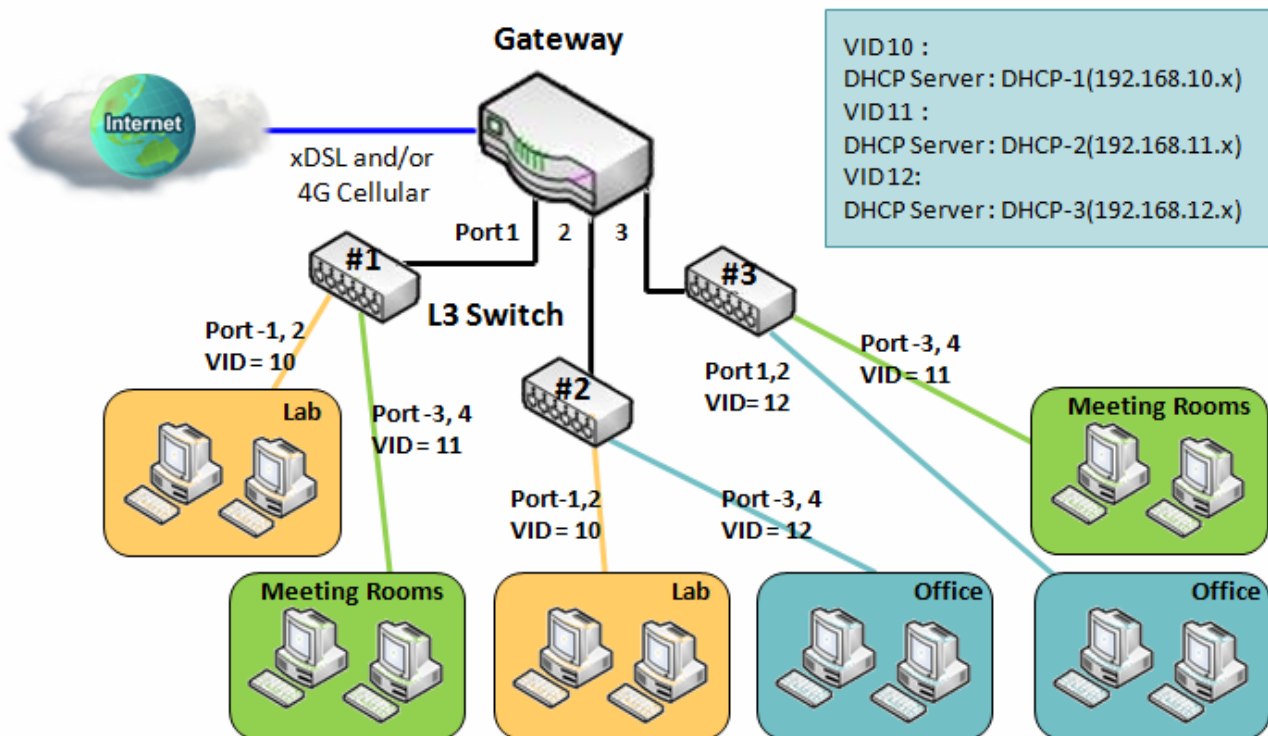

4G Vehicle Gateway

➤ VLAN Groups Access Control

Administrator can specify the Internet access permission for all VLAN groups. He can also configure which VLAN groups are allowed to communicate with each other.

VLAN Group Internet Access

Administrator can specify members of one VLAN group to be able to access Internet or not. Following is an example that VLAN groups of VID is 2 and 3 can access Internet but the one with VID is 1 cannot access Internet. That is, visitors in meeting room and staffs in office network can access Internet. But the computers/servers in data center cannot access Internet since security consideration. Servers in data center only for trusted staffs or are accessed in secure tunnels.

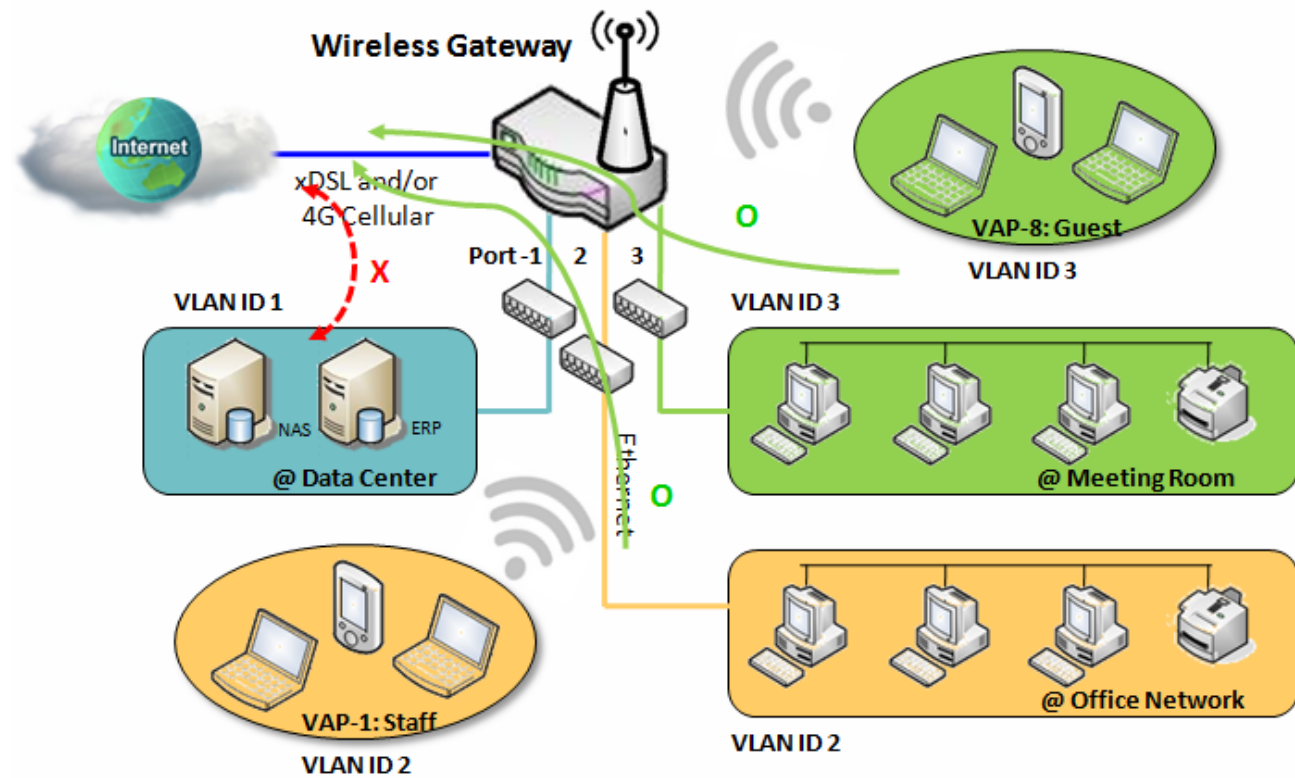

4G Vehicle Gateway

Inter VLAN Group Routing:

In Port-based tagging, administrator can specify member hosts of one VLAN group to be able to communicate with the ones of another VLAN group or not. This is a communication pair, and one VLAN group can join many communication pairs. But communication pair doesn't have the transitive property. That is, A can communicate with B, and B can communicate with C, it doesn't imply that A can communicate with C. An example is shown at following diagram. VLAN groups of VID is 1 and 2 can access each other but the ones between VID 1 and VID 3 and between VID 2 and VID 3 can't.

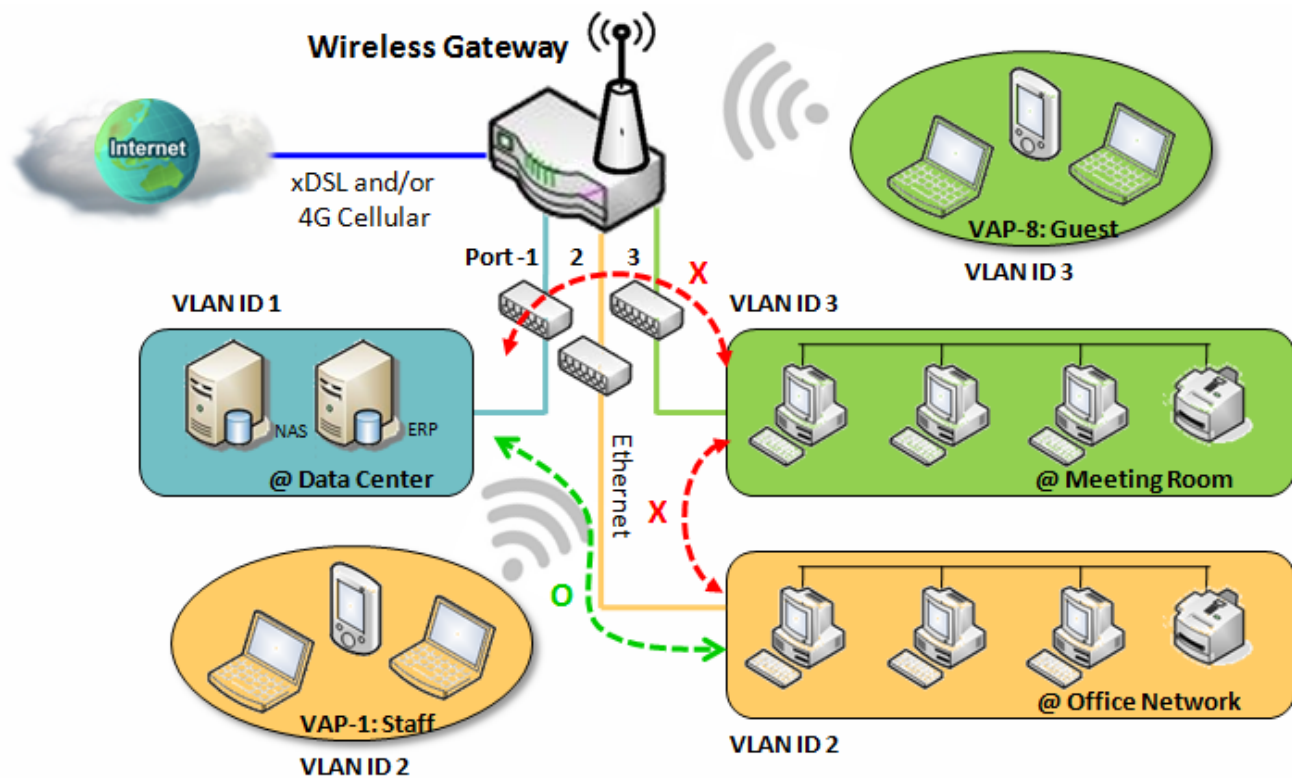

4G Vehicle Gateway

VLAN Setting

Go to **Basic Network > LAN & VLAN > VLAN** Tab.

The VLAN function allows you to divide local network into different virtual LANs. There are Port-based and Tag-based VLAN types. Select one that applies.

Configuration	
Item	Setting
VLAN Types	Port-based ▼
System Reserved VLAN ID	Start ID <input type="text" value="1"/> (1-4091) ~ End ID <input type="text" value="5"/>

Item	Value setting	Description
VLAN Type	Port-based is selected by default	Select the VLAN type that you want to adopt for organizing you local subnets. Port-based: Port-based VLAN allows you to add rule for each LAN port, and you can do advanced control with its VLAN ID. Tag-based: Tag-based VLAN allows you to add VLAN ID, and select member and DHCP Server for this VLAN ID. Go to Tag-based VLAN List table.
System Reserved VLAN ID	1 ~ 5 is reserved by default	Specify the VLAN ID range that is reserved for the system operation. For the Port-based/Tag-based VLAN grouping, only use the ID outside the reserved range. Value Range: 1 ~ 4091.
Save	NA	Click the Save button to save the configuration

Port-based VLAN – Create/Edit VLAN Rules

The port-based VLAN allows you to custom each LAN port. There is a default rule shows the configuration of all LAN ports. Also, if your device has a DMZ port, you will see DMZ configuration, too. The maxima rule numbers is based on LAN port numbers.

Port-based VLAN List										
Name	VLAN ID	VLAN Tagging	NAT / Bridge	Port Members	LAN IP Address	Subnet Mask	Joined WAN	WAN VID	Enable	Actions
DMZ	4094	X	NAT	DMZ Port	192.168.6.254	255.255.255.0	WAN - 1	0	<input checked="" type="checkbox"/>	<input type="button" value="Edit"/>
LAN	Native VLAN	X	NAT	<input type="button" value="Detail"/>	192.168.123.254	255.255.255.0	All WANs	0	<input checked="" type="checkbox"/>	<input type="button" value="Edit"/>

When **Add** button is applied, Port-based VLAN Configuration screen will appear, which is including 3 sections: **Port-based VLAN Configuration**, **IP Fixed Mapping Rule List**, and **Inter VLAN Group Routing** (enter through a button)

4G Vehicle Gateway

Port-based VLAN - Configuration

Port-based VLAN Configuration	
Item	Setting
▶ Name	VLAN - 1
▶ VLAN ID	
▶ VLAN Tagging	Disable ▾
▶ NAT / Bridge	NAT ▾
▶ Port Members	Port: <input type="checkbox"/> Port-2 <input type="checkbox"/> Port-3 2.4G: <input type="checkbox"/> VAP-1 <input type="checkbox"/> VAP-2 <input type="checkbox"/> VAP-3 <input type="checkbox"/> VAP-4 <input type="checkbox"/> VAP-5 <input type="checkbox"/> VAP-6 <input type="checkbox"/> VAP-7 <input type="checkbox"/> VAP-8 5G: <input type="checkbox"/> VAP-1 <input type="checkbox"/> VAP-2 <input type="checkbox"/> VAP-3 <input type="checkbox"/> VAP-4 <input type="checkbox"/> VAP-5 <input type="checkbox"/> VAP-6 <input type="checkbox"/> VAP-7 <input type="checkbox"/> VAP-8
▶ LAN to Join	<input type="checkbox"/> Enable <input type="text" value="DHCP 1"/> ▾

Port-based VLAN Configuration (part-I)		
Item	Value setting	Description
Name	1. A Must filled setting 2. String format: already have default texts	Define the Name of this rule. It has a default text and cannot be modified.
VLAN ID	A Must filled setting	Define the VLAN ID number, range is 1~4094.
VLAN Tagging	Disable is selected by default.	The rule is activated according to VLAN ID and Port Members configuration when Enable is selected. The rule is activated according Port Members configuration when Disable is selected.
NAT / Bridge	NAT is selected by default.	Select NAT mode or Bridge mode for the rule.
Port Members	These boxes are unchecked by default.	Select which LAN port(s) and VAP(s) that you want to add to the rule. Note: The available member list can be different for the purchased product.
LAN to Join	The box is unchecked by default.	Check the Enable box and select one of the defined DHCP Server for the List to define the DHCP server for the VLAN group. If you enabled this function, all the rest settings will be greyed out, not required to configured manually.
Save	NA	Click the Save button to save the configuration
Undo	NA	Click the Undo button to restore what you just configured back to the previous setting.

If you didn't decide to bind the VLAN group to a pre-defined DHCP server, you have to further specify the following settings.

4G Vehicle Gateway

▶ WAN & WAN VID to Join	All WANs ▾ <input type="button" value="None"/>
▶ LAN IP Address	<input type="text" value="192.168.2.254"/>
▶ Subnet Mask	<input type="text" value="255.255.255.0 (/24)"/> ▾
▶ DHCP Server / Relay	Server ▾
▶ DHCP Server Name	<input type="text"/>
▶ IP Pool	Starting Address: <input type="text" value="192.168.2.100"/> Ending Address: <input type="text" value="192.168.2.200"/>
▶ Lease Time	<input type="text" value="86400"/> seconds
▶ Domain Name	<input type="text"/> (Optional)
▶ Primary DNS	<input type="text"/> (Optional)
▶ Secondary DNS	<input type="text"/> (Optional)
▶ Primary WINS	<input type="text"/> (Optional)
▶ Secondary WINS	<input type="text"/> (Optional)
▶ Gateway	<input type="text"/> (Optional)
▶ Enable	<input type="checkbox"/>

Port-based VLAN Configuration (part-II)		
Item	Value setting	Description
WAN & WAN VID to Join	All WANs is selected by default.	Select which WAN or All WANs that allow accessing Internet. Note: If Bridge mode is selected, you need to select a WAN and enter a VID.
LAN IP Address	A Must filled setting	Assign an IP Address for the DHCP Server that the rule used, this IP address is a gateway IP.
Subnet Mask	255.255.255.0(/24) is selected by default.	Select a Subnet Mask for the DHCP Server.
DHCP Server /Relay	Server is selected by default.	Define the DHCP Server type. There are three types you can select: Server , Relay , and Disable . Relay : Select Relay to enable DHCP Relay function for the VLAN group, and you only need to fill the DHCP Server IP Address field. Server : Select Server to enable DHCP Server function for the VLAN group, and you need to specify the DHCP Server settings. Disable : Select Disable to disable the DHCP Server function for the VLAN group.
DHCP Server IP Address (for DHCP Relay only)	A Must filled setting	If you select Relay type of DHCP Server, assign a DHCP Server IP Address that the gateway will relay the DHCP requests to the assigned DHCP server.
DHCP Option 82 (for DHCP Relay only)	An Optional filled setting	If you select Relay type of DHCP Server, you can further enable the DHCP Option 82 setting if the DHCP server support it.
DHCP Server Name	A Must filled setting	Define name of the DHCP Server for the specified VLAN group.
IP Pool	A Must filled setting	Define the IP Pool range. There are Starting Address and Ending Address fields. If a client requests an IP address from this DHCP Server, it will assign an IP address in the range of IP pool .

4G Vehicle Gateway

Lease Time	A Must filled setting	Define a period of time for an IP Address that the DHCP Server leases to a new device. By default, the lease time is 86400 seconds.
Domain Name	String format can be any text	The Domain Name of this DHCP Server. Value Range: 0 ~ 31 characters.
Primary DNS	IPv4 format	The Primary DNS of this DHCP Server.
Secondary DNS	IPv4 format	The Secondary DNS of this DHCP Server.
Primary WINS	IPv4 format	The Primary WINS of this DHCP Server.
Secondary WINS	IPv4 format	The Secondary WINS of this DHCP Server.
Gateway	IPv4 format	The Gateway of this DHCP Server.
Enable	The box is unchecked by default.	Click Enable box to activate this rule.
Save	NA	Click the Save button to save the configuration
Undo	NA	Click the Undo button to restore what you just configured back to the previous setting.

4G Vehicle Gateway

Besides, you can add some IP rules in the **IP Fixed Mapping Rule List** if DHCP Server for the VLAN groups is required.

IP Fixed Mapping Rule List <input type="button" value="Add"/> <input type="button" value="Delete"/>			
MAC Address	IP Address	Enable	Actions

When **Add** button is applied, **Mapping Rule Configuration** screen will appear.

Mapping Rule Configuration		
Item	Value setting	Description
MAC Address	A Must filled setting	Define the MAC Address target that the DHCP Server wants to match.
IP Address	A Must filled setting	Define the IP Address that the DHCP Server will assign. If there is a request from the MAC Address filled in the above field, the DHCP Server will assign this IP Address to the client whose MAC Address matched the rule.
Enable	The box is unchecked by default.	Click Enable box to activate this rule.
Save	NA	Click the Save button to save the configuration

Note: ensure to always click on **Apply** button to apply the changes after the web browser refreshed taken you back to the VLAN page.

Port-based VLAN List <input type="button" value="Add"/> <input type="button" value="Delete"/>										<input type="button" value="↑"/>	<input type="button" value="×"/>
Name	VLAN ID	VLAN Tagging	NAT / Bridge	Port Members	LAN IP Address	Subnet Mask	Joined WAN	WAN VID	Enable	Actions	
LAN	Native VLAN Tag 1	X	NAT	<input type="button" value="Detail"/>	192.168.66.1	255.255.254.0	All WANs	0	<input checked="" type="checkbox"/>	<input type="button" value="Edit"/>	

4G Vehicle Gateway

Port-based VLAN – Inter VLAN Group Routing

Click **VLAN Group Routing** button, the **VLAN Group Internet Access Definition** and **Inter VLAN Group Routing** screen will appear.

VLAN Group Internet Access Definition		
VLAN IDs	Members	Internet Access(WAN)
1	Port : 2,3 2.4G VAP: 1,2,3,4,5,6,7,8 5G VAP: 1,2,3,4,5,6,7,8	Allow <input type="button" value="Edit"/>

Inter VLAN Group Routing		
VLAN IDs	Members	Action
		<input type="button" value="Edit"/>
		<input type="button" value="Edit"/>
		<input type="button" value="Edit"/>
		<input type="button" value="Edit"/>

When **Edit** button is applied, a screen similar to this will appear.

VLAN Group Internet Access Definition		
VLAN IDs	Members	Internet Access(WAN)
<input checked="" type="checkbox"/> 1	Port : 2,3 2.4G VAP: 1,2,3,4,5,6,7,8 5G VAP: 1,2,3,4,5,6,7,8	Allow <input type="button" value="Edit"/>

Inter VLAN Group Routing		
VLAN IDs	Members	Action
<input type="checkbox"/> 1		<input type="button" value="Edit"/>
		<input type="button" value="Edit"/>
		<input type="button" value="Edit"/>
		<input type="button" value="Edit"/>

Inter VLAN Group Routing		
Item	Value setting	Description
VALN Group Internet Access Definition	All boxes are checked by default.	By default, all boxes are checked means all VLAN ID members are allow to access WAN interface. If uncheck a certain VLAN ID box, it means the VLAN ID member can't access Internet anymore.

4G Vehicle Gateway

		Note: VLAN ID 1 is available always; it is the default VLAN ID of LAN rule. The other VLAN IDs are available only when they are enabled.
Inter VLAN Group Routing	The box is unchecked by default.	Click the expected VLAN IDs box to enable the Inter VLAN access function. By default, members in different VLAN IDs can't access each other. The gateway supports up to 4 rules for Inter VLAN Group Routing . For example, if ID_1 and ID_2 are checked, it means members in VLAN ID_1 can access members of VLAN ID_2, and vice versa.
Save	N/A	Click the Save button to save the configuration

Tag-based VLAN – Create/Edit VLAN Rules

The **Tag-based VLAN** allows you to customize each LAN port according to VLAN ID. There is a default rule shows the configuration of all LAN ports and all VAPs. Also, if your device has a DMZ port, you will see DMZ configuration, too. The router supports up to a maximum of 128 tag-based VLAN rule sets.

Tag-based VLAN List						
VLAN ID	Internet	Port Members	Bridge Interface	IP Address	Subnet Mask	Actions
Native VLAN	<input checked="" type="checkbox"/>	Port: <input checked="" type="checkbox"/> Port-2 <input checked="" type="checkbox"/> Port-3 2.4G: <input checked="" type="checkbox"/> VAP-1 <input checked="" type="checkbox"/> VAP-2 <input checked="" type="checkbox"/> VAP-3 <input checked="" type="checkbox"/> VAP-4 <input checked="" type="checkbox"/> VAP-5 <input checked="" type="checkbox"/> VAP-6 <input checked="" type="checkbox"/> VAP-7 <input checked="" type="checkbox"/> VAP-8 5G: <input checked="" type="checkbox"/> VAP-1 <input checked="" type="checkbox"/> VAP-2 <input checked="" type="checkbox"/> VAP-3 <input checked="" type="checkbox"/> VAP-4 <input checked="" type="checkbox"/> VAP-5 <input checked="" type="checkbox"/> VAP-6 <input checked="" type="checkbox"/> VAP-7 <input checked="" type="checkbox"/> VAP-8	DHCP 1			<input type="button" value="Edit"/> <input type="button" value="Select"/>

When **Add** button is applied, **Tag-based VLAN Configuration** screen will appear.

Item	Setting
VLAN ID	<input type="text" value="0"/>
Internet Access	<input checked="" type="checkbox"/> Enable
Port Members	Port: <input type="checkbox"/> Port-2 <input type="checkbox"/> Port-3 2.4G: <input type="checkbox"/> VAP-1 <input type="checkbox"/> VAP-2 <input type="checkbox"/> VAP-3 <input type="checkbox"/> VAP-4 <input type="checkbox"/> VAP-5 <input type="checkbox"/> VAP-6 <input type="checkbox"/> VAP-7 <input type="checkbox"/> VAP-8 5G: <input type="checkbox"/> VAP-1 <input type="checkbox"/> VAP-2 <input type="checkbox"/> VAP-3 <input type="checkbox"/> VAP-4 <input type="checkbox"/> VAP-5 <input type="checkbox"/> VAP-6 <input type="checkbox"/> VAP-7 <input type="checkbox"/> VAP-8
Bridge Interface	<input type="text" value="DHCP 1"/>

Tag-based VLAN Configuration (Part-I)		
Item	Value setting	Description
VALN ID	A Must filled setting	Define the VLAN ID number, that is outside the system reserved range. Value Range: 1 ~ 4095.
Internet Access	The box is checked by default.	Click Enable box to allow the members in the VLAN group access to internet.
Port Members	The boxes are unchecked by default.	Check the LAN port box(es) to join the VLAN group. Check the VAP box(es) to join the VLAN group. Note: Only the wireless gateway has the VAP list.
Bridge Interface	DHCP 1 is selected by default.	Select a predefined DHCP Server , a New to defined a new DHCP server for these members of this VLAN group.
Save	N/A	Click Save button to save the configuration Note: After clicking Save button, always click Apply button to apply the settings.

4G Vehicle Gateway

If you select New to create a new DHCP server setting for the VLAN group, you have to further specify the following configuration.

▶ IP Address	<input type="text"/>
▶ Subnet Mask	255.255.255.0 (/24) ▼
▶ DHCP Relay	<input type="checkbox"/> Enable & Server IP : <input type="text"/>
▶ WAN Interface	WAN - 1 ▼
▶ DHCP Relay Option 82	<input type="checkbox"/> Enable

Tag-based VLAN Configuration (part-II)

Item	Value setting	Description
IP Address	A Must filled setting	Assign an IP Address for the DHCP Server that the rule used, this IP address is a gateway IP.
Subnet Mask	255.255.255.0(/24) is selected by default.	Select a Subnet Mask for the DHCP Server.
DHCP Relay	The box is unchecked by default.	Check the box to enable the DHCP Relay function for the VLAN group, and you only need to fill the DHCP Server IP Address field.
WAN Interface	WAN-1 is selected by default.	Select which WAN interface that allow accessing Internet.
DHCP Option 82	An Optional filled setting	If you select Relay type of DHCP Server, you can further enable the DHCP Option 82 setting if the DHCP server support it.
Save	NA	Click the Save button to save the configuration
Undo	NA	Click the Undo button to restore what you just configured back to the previous setting.

Tag-based VLAN Summary

The configured tag-based VLAN group information will be displayed in the following screen.

Tag-based VLAN Summary	
Port	VLAN IDs
Port2	Native VLAN
Port3	Native VLAN

4G Vehicle Gateway

2.2.3 DHCP Server

➤ DHCP Server

The gateway supports up to 4 DHCP servers to fulfill the DHCP requests from different VLAN groups (please refer to VLAN section for getting more usage details). And there is one default setting for whose LAN IP Address is the same one of gateway LAN interface, with its default Subnet Mask setting as “255.255.255.0”, and its default IP Pool ranges is from “.100” to “.200” as shown at the DHCP Server List page on gateway’s WEB UI.

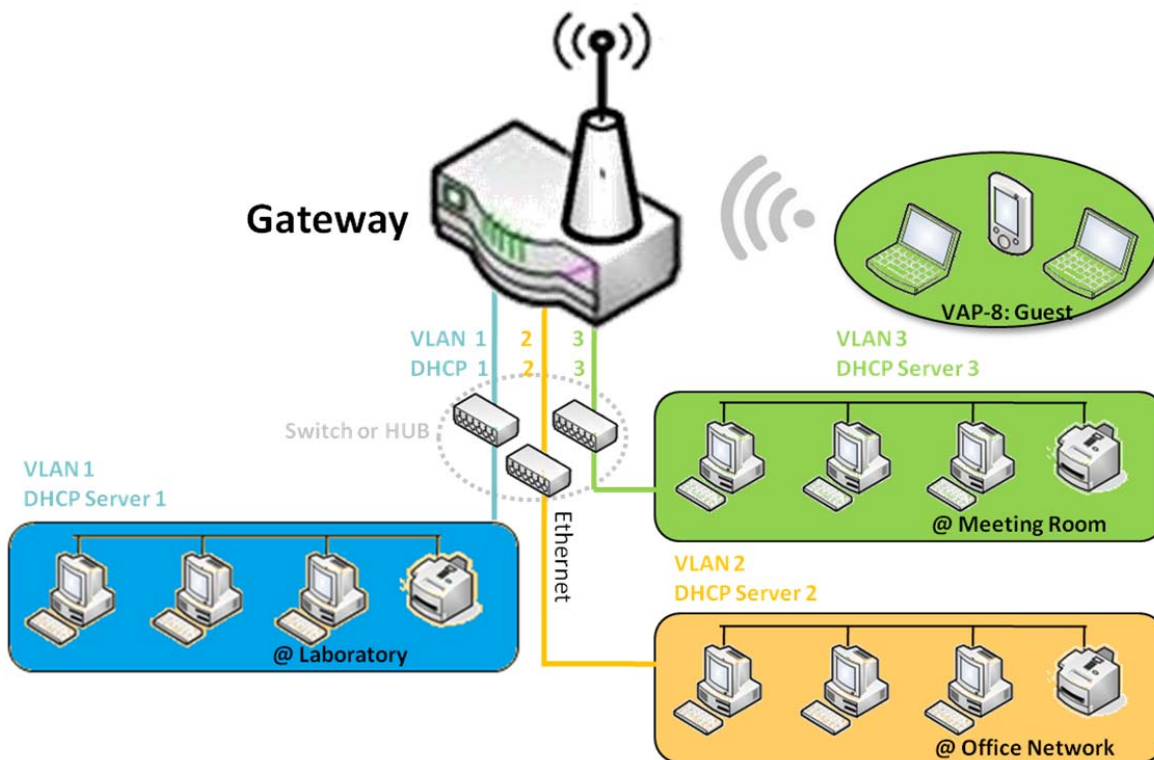

User can add more DHCP server configurations by clicking on the “Add” button behind “DHCP Server List”, or clicking on the “Edit” button at the end of each DHCP Server on list to edit its current settings. Besides, user can select a DHCP Server and delete it by clicking on the “Select” check-box and the “Delete” button.

4G Vehicle Gateway

➤ Fixed Mapping

User can assign fixed IP address to map the specific client MAC address by select them then copy, when targets were already existed in the *DHCP Client List*, or to add some other Mapping Rules by manually in advance, once the target's MAC address was not ready to connect.

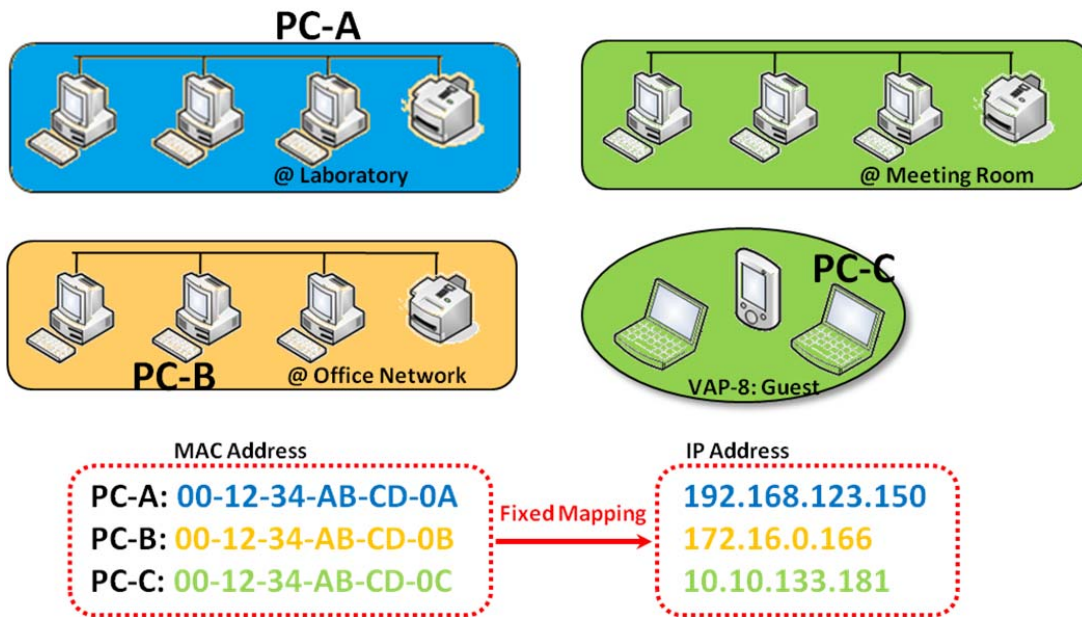

4G Vehicle Gateway

DHCP Server Setting

Go to **Basic Network > LAN & VLAN > DHCP Server** Tab.

The DHCP Server setting allows user to create and customize DHCP Server policies to assign IP Addresses to the devices on the local area network (LAN).

Create / Edit DHCP Server Policy

The gateway allows you to custom your DHCP Server Policy. If multiple LAN ports are available, you can define one policy for each LAN (or VLAN group), and it supports up to a maximum of 4 policy sets.

DHCP Server List												
DHCP Server Name	LAN IP Address	Subnet Mask	IP Pool	Lease Time	Domain Name	Primary DNS	Secondary DNS	Primary WINS	Secondary WINS	Gateway	Enable	Actions
DHCP 1	192.168.66.1	255.255.254.0	192.168.66.100-192.168.66.200	900		0.0.0.0	0.0.0.0	0.0.0.0	0.0.0.0	0.0.0.0	<input checked="" type="checkbox"/>	Edit Fixed Mapping

When **Add** button is applied, **DHCP Server Configuration** screen will appear.

DHCP Server Configuration	
Item	Setting
DHCP Server Name	<input type="text" value="DHCP 2"/>
LAN IP Address	<input type="text" value="192.168.2.1"/>
Subnet Mask	<input type="text" value="255.255.255.0 (/24)"/>
IP Pool	Starting Address: <input type="text"/> Ending Address: <input type="text"/>
Lease Time	<input type="text" value="86400"/> seconds
Domain Name	<input type="text"/> (Optional)
Primary DNS	<input type="text"/> (Optional)
Secondary DNS	<input type="text"/> (Optional)
Primary WINS	<input type="text"/> (Optional)
Secondary WINS	<input type="text"/> (Optional)
Gateway	<input type="text"/> (Optional)

4G Vehicle Gateway

DHCP Server Configuration		
Item	Value setting	Description
DHCP Server Name	1. String format can be any text 2. A Must filled setting	Enter a DHCP Server name. Enter a name that is easy for you to understand.
LAN IP Address	1. IPv4 format. 2. A Must filled setting	The LAN IP Address of this DHCP Server.
Subnet Mask	255.0.0.0 (/8) is set by default	The Subnet Mask of this DHCP Server.
IP Pool	1. IPv4 format. 2. A Must filled setting	The IP Pool of this DHCP Server. It composed of Starting Address entered in this field and Ending Address entered in this field.
Lease Time	1. Numeric string format. 2. A Must filled setting	The Lease Time of this DHCP Server. Value Range: 300 ~ 604800 seconds.
Domain Name	String format can be any text	The Domain Name of this DHCP Server.
Primary DNS	IPv4 format	The Primary DNS of this DHCP Server.
Secondary DNS	IPv4 format	The Secondary DNS of this DHCP Server.
Primary WINS	IPv4 format	The Primary WINS of this DHCP Server.
Secondary WINS	IPv4 format	The Secondary WINS of this DHCP Server.
Gateway	IPv4 format	The Gateway of this DHCP Server.
Server	The box is unchecked by default.	Click Enable box to activate this DHCP Server.
Save	N/A	Click the Save button to save the configuration
Undo	N/A	Click the Undo button to restore what you just configured back to the previous setting.
Back	N/A	When the Back button is clicked the screen will return to the DHCP Server Configuration page.

Create / Edit Mapping Rule List on DHCP Server

The gateway allows you to custom your Mapping Rule List on DHCP Server. It supports up to a maximum of 64 rule sets. When **Fix Mapping** button is applied, the **Mapping Rule List** screen will appear.

MAC Address	IP Address	Enable	Actions
-------------	------------	--------	---------

When **Add** button is applied, **Mapping Rule Configuration** screen will appear.

4G Vehicle Gateway

Mapping Rule Configuration	
Item	Setting
▶ MAC Address	<input type="text"/>
▶ IP Address	<input type="text"/>
▶ Rule	<input type="checkbox"/> Enable

Item	Value setting	Description
MAC Address	1. MAC Address string format 2. A Must filled setting	The MAC Address of this mapping rule.
IP Address	1. IPv4 format. 2. A Must filled setting	The IP Address of this mapping rule.
Rule	The box is unchecked by default.	Click Enable box to activate this rule.
Save	N/A	Click the Save button to save the configuration
Undo	N/A	Click the Undo button to restore what you just configured back to the previous setting.
Back	N/A	When the Back button is clicked the screen will return to the DHCP Server Configuration page.

View / Copy DHCP Client List

When **DHCP Client List** button is applied, **DHCP Client List** screen will appear.

DHCP Client List Copy to Fixed Mapping					
LAN Interface	IP Address	Host Name	MAC Address	Remaining Lease Time	Actions
Ethernet	Dynamic /192.168.123.100	James-P45V	74:D0:2B:62:8D:42	00:49:07	<input type="checkbox"/> Select

DHCP Client List Copy to Fixed Mapping					
LAN Interface	IP Address	Host Name	MAC Address	Remaining Lease Time	Actions
					<input type="checkbox"/> Select

When the DHCP Client is selected and **Copy to Fixed Mapping** button is applied. The IP and MAC address of DHCP Client will apply to the Mapping Rule List on specific DHCP Server automatically.

Enable / Disable DHCP Server Options

The **DHCP Server Options** setting allows user to set **DHCP OPTIONS 66, 72, or 114**. Click the **Enable** button to activate the DHCP option function, and the DHCP Server will add the expected options in its sending out DHCPOFFER DHCPACK packages.

4G Vehicle Gateway

Option	Meaning	RFC
66	TFTP server name	[RFC 2132]
72	Default World Wide Web Server	[RFC 2132]
114	URL	[RFC 3679]

Configuration
▲ ✕

Item	Setting
▶ DHCP Server Options	<input type="checkbox"/> Enable

Create / Edit DHCP Server Options

The gateway supports up to a maximum of 99 option settings.

DHCP Server Option List
Add Delete
▲ ✕

ID	Option Name	DHCP Sever Select	Option Select	Type	Value	Enable	Actions
----	-------------	-------------------	---------------	------	-------	--------	---------

When **Add/Edit** button is applied, **DHCP Server Option Configuration** screen will appear.

DHCP Server Option Configuration
▲ ✕

Item	Setting
▶ Option Name	<input type="text" value="Option 1"/>
▶ DHCP Sever Select	<input type="text" value="DHCP 1"/>
▶ Option Select	<input type="text" value="DHCP OPTION 66"/>
▶ Type	<input type="text" value="Single IP Address"/>
▶ Value	<input type="text"/>
▶ Enable	<input type="checkbox"/> Enable

DHCP Server Option Configuration		
Item	Value setting	Description
Option Name	1. String format can be any text 2. A Must filled setting.	Enter a DHCP Server Option name. Enter a name that is easy for you to understand.
DHCP Server Select	Dropdown list of all available DHCP servers.	Choose the DHCP server this option should apply to.
Option Select	1. A Must filled setting. 2. Option 66 is selected by default.	Choose the specific option from the dropdown list. It can be Option 66, Option 72, Option 144, Option 42, Option 150, or Option 160. Option 42 for ntp server;

4G Vehicle Gateway

		Option 66 for tftp; Option 72 for www; Option 144 for url;														
Type	Dropdown list of DHCP server option value's type	Each different options has different value types.														
		66	Single IP Address													
			Single FQDN													
		72	IP Addresses List, separated by “,”													
		114	Single URL													
		42	IP Addresses List, separated by “,”													
		150	IP Addresses List, separated by “,”													
Value	1. IPv4 format 2. FQDN format 3. IP list 4. URL format 5. A Must filled setting	Should conform to Type :														
			<table border="1"> <thead> <tr> <th>Type</th> <th>Value</th> </tr> </thead> <tbody> <tr> <td rowspan="2">66</td> <td>Single IP Address</td> <td>IPv4 format</td> </tr> <tr> <td>Single FQDN</td> <td>FQDN format</td> </tr> <tr> <td>72</td> <td>IP Addresses List, separated by “,”</td> <td>IPv4 format, separated by “,”</td> </tr> <tr> <td>114</td> <td>Single URL</td> <td>URL format</td> </tr> </tbody> </table>	Type	Value	66	Single IP Address	IPv4 format	Single FQDN	FQDN format	72	IP Addresses List, separated by “,”	IPv4 format, separated by “,”	114	Single URL	URL format
		Type	Value													
		66	Single IP Address	IPv4 format												
			Single FQDN	FQDN format												
72	IP Addresses List, separated by “,”	IPv4 format, separated by “,”														
114	Single URL	URL format														
Enable	The box is unchecked by default.	Click Enable box to activate this setting.														
Save	NA	Click the Save button to save the setting.														
Undo	NA	When the Undo button is clicked the screen will return back with nothing changed.														

Create / Edit DHCP Relay

The gateway supports up to a maximum of 6 DHCP Relay configurations.

DHCP Relay Configuration List							
ID	Agent Name	LAN interface	WAN interface	Server IP	DHCP Relay Option 82	Enable	Actions

When **Add/Edit** button is applied, **DHCP Relay Configuration** screen will appear.

4G Vehicle Gateway

DHCP Relay Configuration	
Item	Setting
▶ Agent Name	<input type="text"/>
▶ LAN interface	LAN ▼
▶ WAN interface	WAN - 1 ▼
▶ Server IP	<input type="text"/>
▶ DHCP OPTION 82	<input type="checkbox"/>
▶ Enable	<input type="checkbox"/>

DHCP Relay Configuration		
Item	Value setting	Description
Agent Name	1. String format can be any text 2. A Must filled setting.	Enter a DHCP Relay name. Enter a name that is easy for you to understand. Value Range: 1~64 characters.
LAN Interface	1. A Must filled setting. 2. LAN is selected by default.	Choose a LAN Interface for the dropdown list to apply with the DHCP Relay function.
WAN Interface	1. A Must filled setting. 2. WAN-1 is selected by default.	Choose a WAN Interface for the dropdown list to apply with the DHCP Relay function. It can be the available WAN interface(s), and L2TP connection.
Server IP	1. A Must filled setting. 2. null by default.	Assign a DHCP Server IP Address that the gateway will relay the DHCP requests to the assigned DHCP server via specified WAN interface.
DHCP OPTION 82	The box is unchecked by default.	Click Enable box to activate DHCP OPTION 82 function. Option 82 is organized as a single DHCP option that contains circuit-ID information known by the relay agent. If the relayed DHCP server required the such information, you have to enable it, otherwise, just leave it as unchecked.
Enable	The box is unchecked by default.	Click Enable box to activate this setting.
Save	NA	Click the Save button to save the setting.
Undo	NA	When the Undo button is clicked the screen will return back with nothing changed.

4G Vehicle Gateway

2.3 WiFi

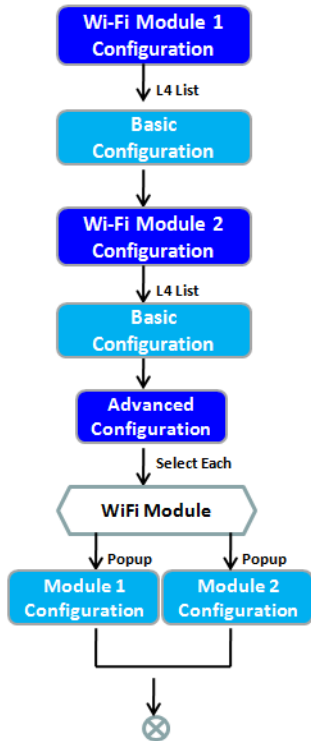

Basic Configuration								
Item	Setting							
Operation Band	2.4G Single Band							
2.4G WiFi Configuration								
Item	Setting							
WiFi Module	<input checked="" type="checkbox"/> Enable							
Channel	Auto <input checked="" type="radio"/> By AP Numbers <input type="radio"/> By Less Interference							
WiFi System	802.11b/g/n Mixed							
WiFi Operation Mode	AP Router Mode							
Green AP	<input type="checkbox"/> Enable							
VAP Isolation	<input checked="" type="checkbox"/> Enable							
Time Schedule	(0) Always							
2.4G VAP List								
Add Delete								
ID	VAP	SSID	Authentication	Encryption	STA Isolation	Broadcast SSID	Enable	Actions

The gateway provides WiFi interface for mobile devices or BYOD devices to connect for Internet/Intranet accessing. WiFi function is usually modularized design in a gateway, and there can be single or dual modules within a gateway. The WiFi system in the gateway complies with IEEE 802.11ac/11n/11g/11b standard in 2.4GHz or 5GHz single band or 2.4G/5GHz concurrent dual bands of operation. There are several wireless operation modes provided by this device. They are: “**AP Router Mode**”, “**WDS Only Mode**”, and “**WDS Hybrid Mode**”. You can choose the expected mode from the wireless operation mode list.

There are some sub-sections for you to configure the WiFi function, including “Basic Configuration” and “Advanced Configuration”. In Basic Configuration section, you have to finish almost all the settings for using the WiFi function. And the Advanced Configuration section provides more parameters for advanced user to fine tune the connectivity performance for the WiFi function.

4G Vehicle Gateway

2.3.1 WiFi Configuration

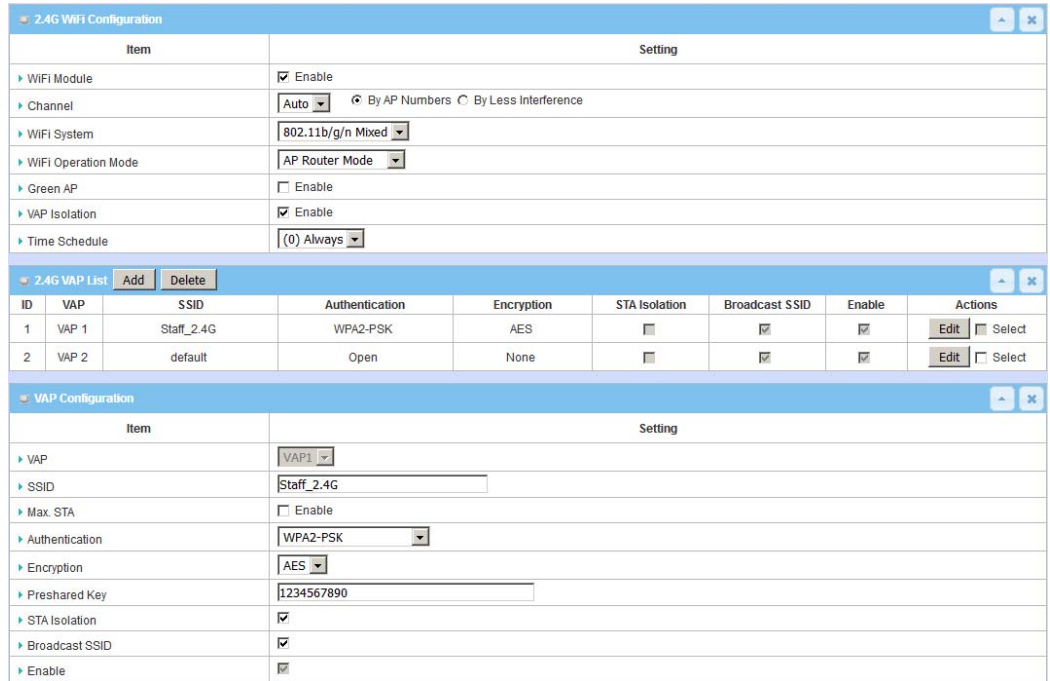
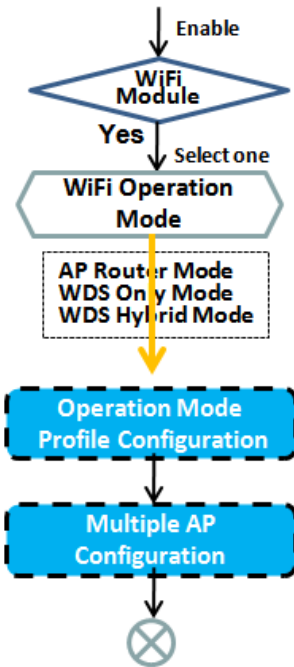

Due to optional module(s) and frequency band, you need to setup module one by one. For each module, you need to specify the operation mode, and then setup the virtual APs for wireless access.

Hereunder are the scenarios for each wireless operation mode, you can get how it works, and what is the difference among them. To connect your wireless devices with the wireless gateway, make sure your application scenario for WiFi network and choose the most adequate operation mode.

AP Router Mode

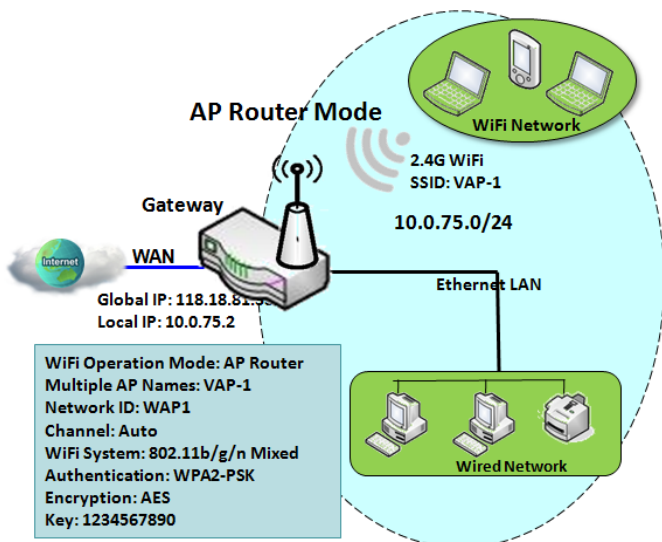

This mode allows you to get your wired and wireless devices connected to form the Intranet of the wireless gateway, and the Intranet will link to the Internet with NAT mechanism of the gateway. So, this gateway is working as a WiFi AP, but also a WiFi hotspot for Internet accessing service. It means local WiFi clients can associate to it, and go to Internet. With its NAT mechanism, all of wireless clients don't need to get public IP addresses from ISP.

4G Vehicle Gateway

WDS Only Mode

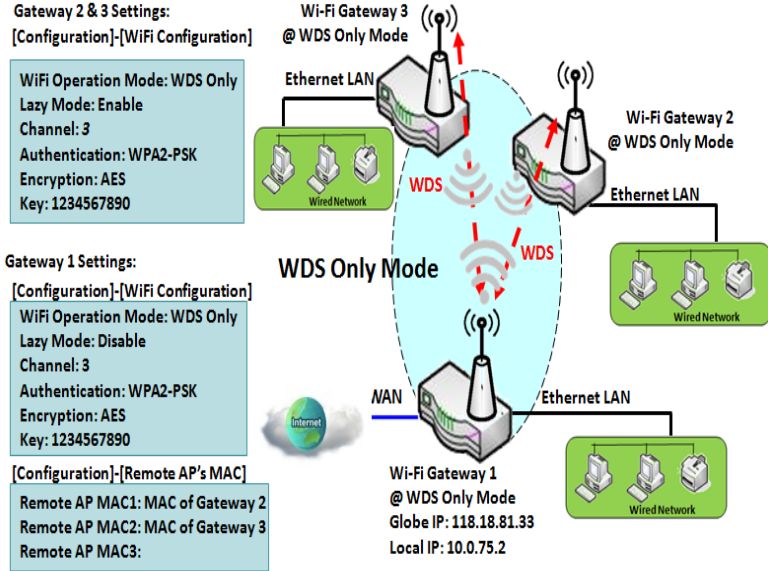

WDS (Wireless Distributed System) Only mode drives a WiFi gateway to be a bridge for its wired Intranet and a repeater to extend distance. You can use multiple WiFi gateways as a WiFi repeater chain with all gateways setup as "WDS Only" mode. All gateways can communicate with each other through WiFi. All wired client hosts within each gateway can also communicate each other in the scenario. Only one gateway within repeater chain can be DHCP server to provide IP for all wired client hosts of every gateway which being disabled DHCP server. This gateway can be NAT router to provide internet access. The diagram illustrates that there are two wireless gateways 2, 3 running at "WDS Only"

mode. They both use channel 3 to link to local Gateway 1 through WDS. Both gateways connected by WDS need to setup the remote AP MAC for each other. All client hosts under gateway 2, 3 can request IP address from the DHCP server at gateway 1. Besides, wireless Gateway 1 also execute the NAT mechanism for all client hosts Internet accessing.

WDS Hybrid Mode

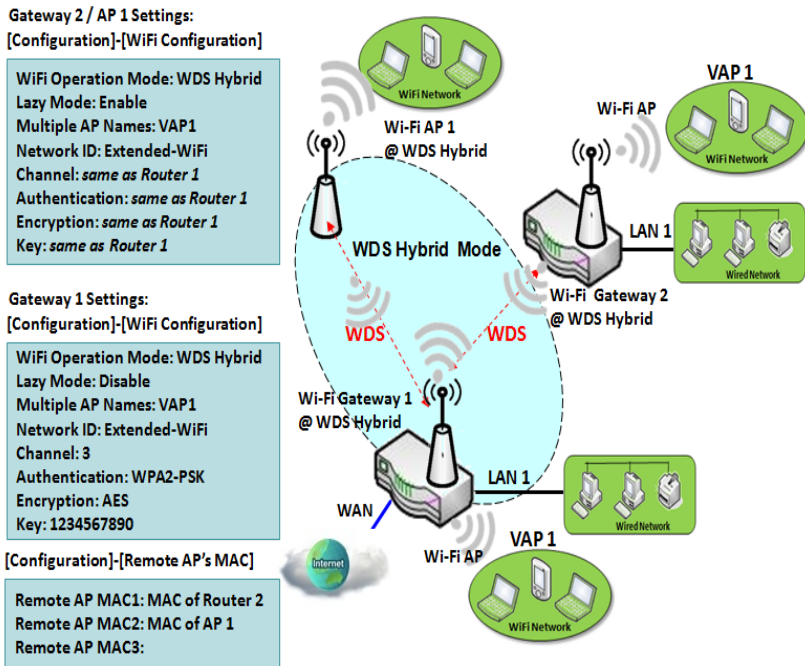

WDS hybrid mode includes both WDS and AP Router mode. WDS Hybrid mode can act as an access point for its WiFi Intranet and a WiFi bridge for its wired and WiFi Intranets at the same time. Users can thus use the features to build up a large wireless network in a large space like airports, hotels or campus.

The diagram illustrates Gateway 1, Gateway 2 and AP 1 connected by WDS. Each gateway has access point function for WiFi client access. Gateway 1 has DHCP server to assign IP to each client hosts. All gateways and AP are under WDS hybrid mode. To setup WDS hybrid mode, it need to fill all configuration items similar to that of AP-router and WDS modes.

4G Vehicle Gateway

Multiple VAPs

Gateway Settings:

WiFi Operation Mode: AP Router
VAP1
 SSID: VAP-1
 Authentication: WPA2-PSK
 Encryption: TKIP
 Key: 1234567890

VAP2
 SSID: VAP-2
 Authentication: WPA2-PSK
 Encryption: TKIP
 Key: 1234567890

VAP3
 SSID: VAP-3
 Authentication: WPA2
 Encryption: TKIP
 RADIUS Server IP: 192.168.168.
 RADIUS Server Port: 1812
 RADIUS Shared Key

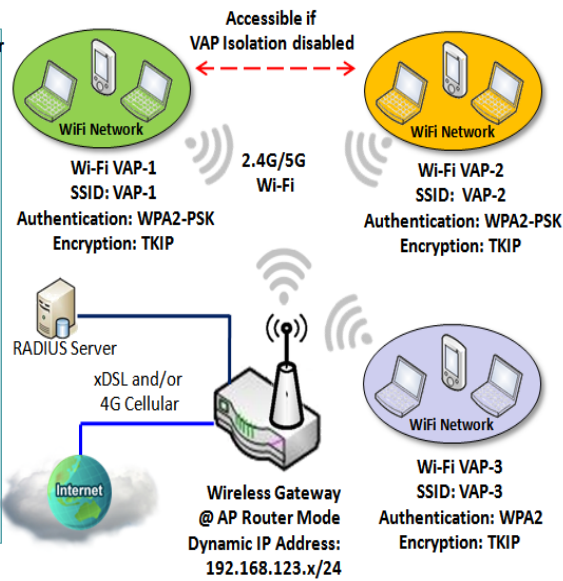

VAP (Virtual Access Point) is function to partition wireless network into multiple broadcast domains. It can simulate multiple APs in one physical AP. This wireless gateway supports up to 8 VAPs. For each VAP, you need to setup SSID, authentication and encryption to control Wi-Fi client access.

Besides, there is a VAP isolation option to manage the access among VAPs. You can allow or blocks communication for the wireless clients connected to different VAPs. As shown in the diagram, the clients in VAP-1 and VAP-2 can communicate to each other when VAP Isolation is disabled.

Wi-Fi Security – Authentication & Encryption

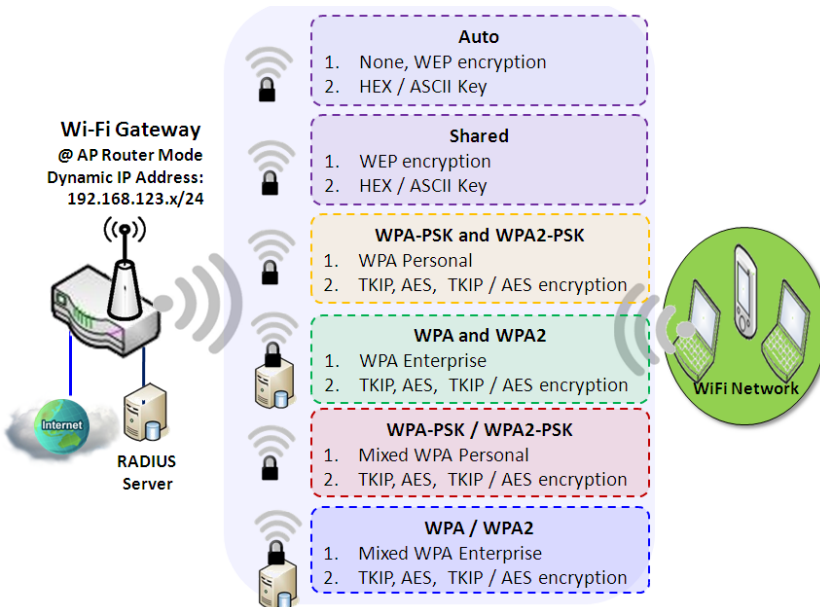

Wi-Fi security provides complete authentication and encryption mechanisms to enhance the data security while your data is transferred wirelessly over the air. The wireless gateway supports Shared, WPA-PSK / WPA2-PSK and WPA / WPA2 authentication. You can select one authentication scheme to validate the wireless clients while they are connecting to the AP. As to the data encryption, the gateway supports WEP, TKIP and AES. The selected encryption algorithm will be applied to the data while the wireless connection is established.

4G Vehicle Gateway

WiFi Configuration Setting

The WiFi configuration allows user to configure 2.4GHz or 5GHz WiFi settings.

Go to **Basic Network > WiFi > WiFi Module One** Tab. If the gateway is equipped with two WiFi modules, there will be another **WiFi Module Two**. You can do the similar configurations on both WiFi modules.

Basic Configuration

Basic Configuration	
Item	Setting
▶ Operation Band	2.4G Single Band

Item	Value setting	Description
Operation Band	A Must filled setting	Specify the intended operation band for the WiFi module. Basically, this setting is fixed and cannot be changed once the module is integrated into the product. However, there is some module with selectable band for user to choose according to his network environment. Under such situation, you can specify which operation band is suitable for the application.

Configure WiFi Setting

2.4G WiFi Configuration	
Item	Setting
▶ WiFi Module	<input checked="" type="checkbox"/> Enable
▶ Channel	Auto <input type="radio"/> By AP Numbers <input type="radio"/> By Less Interference
▶ WiFi System	802.11b/g/n Mixed
▶ WiFi Operation Mode	AP Router Mode

Item	Value setting	Description
WiFi Module	The box is checked by default	Check the Enable box to activate Wi-Fi function.
Channel	1. A Must filled setting. 2. Auto is selected be default.	Select a radio channel for the VAP. Each channel is corresponding to different radio band. The permissible channels depend on the Regulatory Domain . There are two available options when Auto is selected: <ul style="list-style-type: none">● By AP Numbers The channel will be selected according to AP numbers (The less, the better).

4G Vehicle Gateway

		<ul style="list-style-type: none"> ● By Less Interference The channel will be selected according to interference. (The lower, the better).
WiFi System	A Must filled setting	Specify the preferred WiFi System. The dropdown list of WiFi system is based on IEEE 802.11 standard. <ul style="list-style-type: none"> ● 2.4G WiFi can select b, g and n only or mixed with each other. ● 5G WiFi can select a, n and ac only or mixed with each other.
WiFi Operation Mode		Specify the WiFi Operation Mode according to your application. Go to the following table for AP Router Mode , WDS Only Mode , and WDS Hybrid Mode settings. Note: The available operation modes depend on the product specification.

In the following, the specific configuration description for each WiFi operation mode is given.

AP Router Mode & VAPs Configuration

For the AP Router mode, the device not only supports **stations connection** but also the **router function**. The **WAN** port and the **NAT** function are **enabled**.

▶ WiFi Operation Mode	AP Router Mode ▾
▶ Green AP	<input type="checkbox"/> Enable
▶ VAP Isolation	<input checked="" type="checkbox"/> Enable
▶ Time Schedule	(0) Always ▾

AP Router Mode		
Item	Value setting	Description
Green AP	The box is unchecked by default.	Check the Enable box to activate Green AP function.
VAP Isolation	The box is checked by default.	Check the Enable box to activate this function. By default, the box is checked; it means that stations which associated to different VAPs cannot communicate with each other.
Time Schedule	A Must filled setting	Apply a specific Time Schedule to this rule; otherwise leave it as (0) Always . If the dropdown list is empty ensure Time Schedule is pre-configured. Refer to Object Definition > Scheduling > Configuration tab.

2.4G VAP List								Add	Delete
ID	VAP	SSID	Authentication	Encryption	STA Isolation	Broadcast SSID	Enable	Actions	
1	VAP 1	Staff_2.4G	WPA2-PSK	AES	<input type="checkbox"/>	<input checked="" type="checkbox"/>	<input checked="" type="checkbox"/>	Edit <input type="checkbox"/> Select	

By default, VAP 1 is enabled and security key is required to connect to the gateway wirelessly to enhance the security level and prevent unexpected access of un-authorized devices.

The default wifi key is printed on both the device label and the Security Card. It is created randomly and differs from devices. So, you can connected to the VAP1 (SSID: Staff_2.4G) with the provided key.

However, it is strongly recommended that you have to change the security key to a easy-to-remember one

4G Vehicle Gateway

by clicking the Edit button.

Click **Add / Edit** button in the VAP List screen to create or edit the settings for a VAP. A VAP Configuration screen will appear.

For VAP 1:

VAP Configuration	
Item	Setting
▶ VAP	VAP1
▶ SSID	Staff_2.4G
▶ Max. STA	<input type="checkbox"/> Enable
▶ Authentication	WPA2-PSK
▶ Encryption	AES
▶ Preshared Key	1234567890
▶ STA Isolation	<input checked="" type="checkbox"/>
▶ Broadcast SSID	<input checked="" type="checkbox"/>
▶ Enable	<input checked="" type="checkbox"/>

For others:

VAP Configuration	
Item	Setting
▶ VAP	VAP2
▶ SSID	default
▶ Max. STA	<input type="checkbox"/> Enable
▶ Authentication	Open
▶ Encryption	None
▶ STA Isolation	<input type="checkbox"/>
▶ Broadcast SSID	<input type="checkbox"/>
▶ Enable	<input type="checkbox"/>

VAP Configuration		
Item	Value setting	Description
SS ID	1. String format : Any text	Enter the SSID for the VAP, and decide whether to broadcast the SSID or not. The SSID is used for identifying from another AP, and client stations will associate with AP according to SSID.
Max. STA	The box is unchecked	Check this box and enter a limitation to limit the maximum number of client

4G Vehicle Gateway

	<p>by default.</p> <p>station. The box is unchecked by default. It means no special limitation on the number of connected STAs.</p>
<p>Authentication</p> <p>1. A Must filled setting 2. VAP1: WPA2-PSK is selected be default; Others: Open is selected be default.</p>	<p>For security, there are several authentication methods supported. Client stations should provide the key when associate with this device.</p> <p>When Open is selected The check box named 802.1x shows up next to the dropdown list.</p> <ul style="list-style-type: none"> ● 802.1x (The box is unchecked by default) When 802.1x is enabled, it means the client stations will be authenticated by RADIUS server. RADIUS Server IP (The default IP is 0.0.0.0) RADIUS Server Port (The default value is 1812) RADIUS Shared Key <p>When Shared is selected The pre-shared WEP key should be set for authenticating.</p> <p>When Auto is selected The device will select Open or Shared by requesting of client automatically. The check box named 802.1x shows up next to the dropdown list.</p> <ul style="list-style-type: none"> ● 802.1x (The box is unchecked by default) When 802.1x is enabled, it means the client stations will be authenticated by RADIUS server. RADIUS Server IP (The default IP is 0.0.0.0) RADIUS Server Port (The default value is 1812) RADIUS Shared Key <p>When WPA or WPA2 is selected They are implementation of IEEE 802.11i. WPA only had implemented part of IEEE 802.11i, but owns the better compatibility. WPA2 had fully implemented 802.11i standard, and owns the highest security.</p> <ul style="list-style-type: none"> ● RADIUS Server The client stations will be authenticated by RADIUS server. RADIUS Server IP (The default IP is 0.0.0.0) RADIUS Server Port (The default value is 1812) RADIUS Shared Key <p>When WPA / WPA2 is selected It owns the same setting as WPA or WPA2. The client stations can associate with this device via WPA or WPA2.</p> <p>When WPA-PSK or WPA2-PSK is selected It owns the same encryption system as WPA or WPA2. The authentication uses pre-shared key instead of RADIUS server.</p> <p>When WPA-PSK / WPA2-PSK is selected It owns the same setting as WPA-PSK or WPA2-PSK. The client stations can associate with this device via WPA-PSK or WPA2-PSK.</p>
<p>Encryption</p> <p>1. A Must filled setting. 2. VAP1: AES is selected be default; Others: None is selected be default.</p>	<p>Select a suitable encryption method and enter the required key(s). The available method in the dropdown list depends on the Authentication you selected.</p> <p>None It means that the device is open system without encrypting.</p> <p>WEP Up to 4 WEP keys can be set, and you have to select one as current key. The key type can set to HEX or ASCII. If HEX is selected, the key should consist of (0 to 9) and (A to F). If ASCII is selected, the key should consist of ASCII table.</p>

4G Vehicle Gateway

		<p>TKIP TKIP was proposed instead of WEP without upgrading hardware. Enter a Pre-shared Key for it. The length of key is from 8 to 63 characters.</p> <p>AES The newest encryption system in WiFi, it also designed for the fast 802.11n high bitrates schemes. Enter a Pre-shared Key for it. The length of key is from 8 to 63 characters. You are recommended to use AES encryption instead of any others for security.</p> <p>TKIP / AES TKIP / AES mixed mode. It means that the client stations can associate with this device via TKIP or AES. Enter a Pre-shared Key for it. The length of key is from 8 to 63 characters.</p>
STA Isolation	VAP1: The box is checked by default; Others: unchecked by default.	Check the Enable box to activate this function. By default, the box is checked; it means that stations which associated to the same VAP cannot communicate with each other.
Broadcast SSID	VAP1: The box is checked by default; Others: unchecked by default.	Check the Enable box to activate this function. If the broadcast SSID option is enabled, it means the SSID will be broadcasted, and the stations can associate with this device by scanning SSID.
Enable	VAP1: The box is checked by default; Others: unchecked by default.	Check the Enable box to activate this VAP.
Save	N/A	Click the Save button to save the current configuration.
Undo	N/A	Click the Undo button to restore configuration to previous setting before saving.
Apply	N/A	Click the Apply button to apply the saved configuration.

4G Vehicle Gateway

WDS Only Mode

For the WDS Only mode, the device only bridges the connected wired clients to another WDS-enabled WiFi device which the device associated with. That is, it also means the no wireless clients stat can connect to this device while WDS Only Mode is selected.

WiFi Operation Mode	WDS Only Mode ▾
Green AP	<input type="checkbox"/> Enable
Time Schedule	(0) Always ▾
Scan Remote AP's MAC List	Scan
Remote AP MAC 1	<input type="text"/>
Remote AP MAC 2	<input type="text"/>
Remote AP MAC 3	<input type="text"/>
Remote AP MAC 4	<input type="text"/>

WDS Only Mode		
Item	Value setting	Description
Green AP	The box is unchecked by default.	Check the Enable box to activate Green AP function.
Time Schedule	A Must filled setting	Apply a specific Time Schedule to this rule; otherwise leave it as (0) Always . If the dropdown list is empty ensure Time Schedule is pre-configured. Refer to Object Definition > Scheduling > Configuration tab.
Scan Remote AP's MAC List	N/A	Press the Scan button to scan the spatial AP information, and then select one from the AP list, the MAC of selected AP will be auto filled in the following Remote AP MAC table.
Remote AP MAC 1~4	A Must filled setting	Enter the remote AP's MAC manually, or via auto-scan approach, The device will bridge the traffic to the remote AP when associated successfully.

2.4G VAP List								
ID	VAP	SSID	Authentication	Encryption	STA Isolation	Broadcast SSID	Enable	Actions
1	VAP 1	Staff_2.4G	WPA2-PSK	AES	<input type="checkbox"/>	<input checked="" type="checkbox"/>	<input checked="" type="checkbox"/>	<input type="button" value="Edit"/> <input type="checkbox"/> Select

By default, VAP 1 is enabled and security key is required to connect to the gateway wirelessly to enhance the security level and prevent unexpected access of un-authorized devices.

The default wifi key is printed on both the device label and the Security Card. It is created randomly and differs from devices. So, you can connected to the VAP1 (SSID: Staff_2.4G) with the provided key.

However, it is strongly recommended that you have to change the security key to a easy-to-remember one by clicking the Edit button.

4G Vehicle Gateway

Under **WDS Only** mode, only VAP1 is available for further specifying the required authentication and Encryption settings. Click **Edit** button in the VAP List screen and a VAP Configuration screen will appear for you to configure the required settings

VAP Configuration	
Item	Setting
▶ VAP	VAP1
▶ SSID	Staff_2.4G
▶ Max. STA	<input type="checkbox"/> Enable
▶ Authentication	WPA2-PSK
▶ Encryption	AES
▶ Preshared Key	1234567890
▶ STA Isolation	<input checked="" type="checkbox"/>
▶ Broadcast SSID	<input checked="" type="checkbox"/>
▶ Enable	<input checked="" type="checkbox"/>

For the detail description about VAP configuration, please refer to the description stated in AP-Router section.

4G Vehicle Gateway

WDS Hybrid Mode

For the WDS Hybrid mode, the device bridges all the wired **LAN** and **WLAN** clients to another WDS or WDS hybrid enabled WiFi devices which the device associated with.

WiFi Operation Mode	WDS Hybrid Mode ▾
Lazy Mode	<input type="checkbox"/> Enable
Green AP	<input type="checkbox"/> Enable
VAP Isolation	<input checked="" type="checkbox"/> Enable
Time Schedule	(0) Always ▾
Scan Remote AP's MAC List	Scan
Remote AP MAC 1	<input type="text"/>
Remote AP MAC 2	<input type="text"/>
Remote AP MAC 3	<input type="text"/>
Remote AP MAC 4	<input type="text"/>

WDS Hybrid Mode		
Item	Value setting	Description
Lazy Mode	The box is checked by default.	Check the Enable box to activate this function. With the function been enabled, the device can auto-learn WDS peers without manually entering other AP's MAC address. But at least one of the APs has to fill remote AP MAC addresses.
Green AP	The box is unchecked by default.	Check the Enable box to activate Green AP function.
VAP Isolation	The box is checked by default.	Check the Enable box to activate this function. By default, the box is checked; it means that stations which associated to different VAPs cannot communicate with each other.
Time Schedule	A Must filled setting	Apply a specific Time Schedule to this rule; otherwise leave it as (0) Always . If the dropdown list is empty ensure Time Schedule is pre-configured. Refer to Object Definition > Scheduling > Configuration tab.
Scan Remote AP's MAC List	Available when Lazy Mode disabled.	Press the Scan button to scan the spatial AP information, and then select one from the AP list, the MAC of selected AP will be auto filled in the following Remote AP MAC table.
Remote AP MAC 1~4	Available when Lazy Mode disabled.	Enter the remote AP's MAC manually, or via auto-scan approach, The device will bridge the traffic to the remote AP when associated successfully.

2.4G VAP List								
ID	VAP	SSID	Authentication	Encryption	STA Isolation	Broadcast SSID	Enable	Actions
1	VAP 1	Staff_2.4G	WPA2-PSK	AES	<input type="checkbox"/>	<input checked="" type="checkbox"/>	<input checked="" type="checkbox"/>	<input type="button" value="Edit"/> <input type="checkbox"/> Select

By default, VAP 1 is enabled and security key is required to connect to the gateway wirelessly to enhance the security level and prevent unexpected access of un-authorized devices.

The default wifi key is printed on both the device label and the Security Card. It is created randomly and

4G Vehicle Gateway

differs from devices. So, you can connected to the VAP1 (SSID: Staff_2.4G) with the provided key. However, it is strongly recommended that you have to change the security key to a easy-to-remember one by clicking the Edit button.

Under **WDS Hybrid** mode, the VAP function is available and you can further specifying the required VAP settings for connecting with wireless client devices.

Click **Add / Edit** button in the VAP List screen to create or edit the settings for a VAP. A VAP Configuration screen will appear.

For VAP 1:

VAP Configuration	
Item	Setting
▶ VAP	VAP1
▶ SSID	Staff_2.4G
▶ Max. STA	<input type="checkbox"/> Enable
▶ Authentication	WPA2-PSK
▶ Encryption	AES
▶ Preshared Key	1234567890
▶ STA Isolation	<input checked="" type="checkbox"/>
▶ Broadcast SSID	<input checked="" type="checkbox"/>
▶ Enable	<input checked="" type="checkbox"/>

4G Vehicle Gateway

For others:

VAP Configuration	
Item	Setting
▶ VAP	VAP2
▶ SSID	default
▶ Max. STA	<input type="checkbox"/> Enable
▶ Authentication	Open
▶ Encryption	None
▶ STA Isolation	<input type="checkbox"/>
▶ Broadcast SSID	<input type="checkbox"/>
▶ Enable	<input type="checkbox"/>

For the detail description about VAP configuration, please refer to the description stated in AP-Router section.

4G Vehicle Gateway

2.3.2 Wireless Client List

The **Wireless Client List** page shows the information of wireless clients which are associated with this device.

Go to **Basic Network > WiFi > Wireless Client List** Tab.

Select Target WiFi

Target WiFi	
Item	Setting
▶ Module Select	One ▼
▶ Operation Band	2.4G ▼
▶ Multiple AP Names	All ▼

Target Configuration		
Item	Value setting	Description
Module Select	A Must filled setting.	Select the WiFi module to check the information of connected clients. For those single WiFi module products, this option is hidden.
Operation Band	A Must filled setting.	Specify the intended operation band for the WiFi module. Basically, this setting is fixed and cannot be changed once the module is integrated into the product. However, there is some module with selectable band for user to choose according to his network environment. Under such situation, you can specify which operation band is suitable for the application.
Multiple AP Names	1. A Must filled setting. 2. All is selected by default.	Specify the VAP to show the associated clients information in the following Client List. By default, All VAP is selected.

Show Client List

The following Client List shows the information for wireless clients that is associated with the selected VAP(s).

Client List								
IP Address Configuration & Address	Host Name	MAC Address	Mode	Rate	RSSI0	RSSI1	Signal	Interface

Target Configuration		
Item	Value setting	Description
IP Address Configuration & Address	N/A	It shows the Client's IP address and the deriving method. Dynamic means the IP address is derived from a DHCP server. Static means the IP address is a fixed one that is self-filled by client.
Host Name	N/A	It shows the host name of client.
MAC Address	N/A	It shows the MAC address of client.
Mode	N/A	It shows what kind of Wi-Fi system the client used to associate with this device.
Rate	N/A	It shows the data rate between client and this device.

4G Vehicle Gateway

RSSI0, RSSI1	N/A	It shows the RX sensitivity (RSSI) value for each radio path.
Signal	N/A	The signal strength between client and this device.
Interface	N/A	It shows the VAP ID that the client associated with.
Refresh	N/A	Click the Refresh button to update the Client List immediately.

4G Vehicle Gateway

2.3.3 Advanced Configuration

This device provides advanced wireless configuration for professional user to optimize the wireless performance under the specific installation environment. Please note that if you are not familiar with the WiFi technology, just leave the advanced configuration with its default values, or the connectivity and performance may get worse with improper settings.

Go to **Basic Network > WiFi > Advanced Configuration Tab**.

Select Target WiFi

Target WiFi	
Item	Setting
▶ Module Select	One ▼
▶ Operation Band	2.4G ▼

Target Configuration		
Item	Value setting	Description
Module Select	A Must filled setting.	Select the WiFi module to check the information of connected clients. For those single WiFi module products, this option is hidden.
Operation Band	A Must filled setting.	Specify the intended operation band for the WiFi module. Basically, this setting is fixed and cannot be changed once the module is integrated into the product. However, there is some module with selectable band for user to choose according to his network environment.

Setup Advanced Configuration

Advanced Configuration	
Item	Setting
▶ Regulatory Domain	(1-11)
▶ Beacon Interval	100 <input type="text"/> Range: (1~1000 msec)
▶ DTIM Interval	3 <input type="text"/> Range: (1~255)
▶ RTS Threshold	2347 <input type="text"/> Range: (1~2347)
▶ Fragmentation	2346 <input type="text"/> Range: (256~2346)
▶ WMM	<input checked="" type="checkbox"/> Enable
▶ Short GI	400ns ▼
▶ TX Rate	Best ▼
▶ RF Bandwidth	Auto ▼
▶ Transmit Power	100% ▼
▶ WIDS	<input type="checkbox"/> Enable

4G Vehicle Gateway

Advanced Configuration		
Item	Value setting	Description
Regulatory Domain	The default setting is according to where the product sale to	It limits the available radio channel of this device. The permissible channels depend on the Regulatory Domain .
Beacon Interval	100	It shows the time interval between each beacon packet broadcasted. The beacon packet contains SSID , Channel ID and Security setting .
DTIM Interval	3	A DTIM (Delivery Traffic Indication Message) is a countdown informing clients of the next window for listening to broadcast message. When the device has buffered broadcast message for associated client, it sends the next DTIM with a DTIM value.
RTS Threshold	2347	RTS (Request to send) Threshold means when the packet size is over the setting value, then active RTS technique. RTS/CTS is a collision avoidance technique. It means RTS never activated when the threshold is set to 2347 .
Fragmentation	2346	Wireless frames can be divided into smaller units (fragments) to improve performance in the presence of RF interference at the limits of RF coverage.
WMM	The box is checked by default	WMM (Wi-Fi Multimedia) can help control latency and jitter when transmitting multimedia content over a wireless connection.
Short GI	By default 400ns is selected	Short GI (Guard Interval) is defined to set the sending interval between each packet. Note that lower Short GI could increase not only the transition rate but also error rate .
TX Rate	By default Best is selected	It means the data transition rate . When Best is selected, the device will choose a proper data rate according to signal strength .
RF Bandwidth	By default Auto is selected	The setting of RF bandwidth limits the maximum data rate.
Transmit Power	By default 100% is selected	Normally the wireless transmitter operates at 100% power. By setting the transmit power to control the Wi-Fi coverage .
5G Band Steering	The box is unchecked by default	When the client station associate with 2.4G Wi-Fi, the device will send the client to 5G Wi-Fi automatically if the client is available on accessing this 5G Wi-Fi band. This option is only available on the module that supports 5GHz band.
WIDS	The box is unchecked by default	The WIDS (Wireless Intrusion Detection System) will analyze all packets and make a statistic table in WiFi status. Go to Status > Basic Network > WiFi tab for detailed WIDS status.
Save	N/A	Click the Save button to save the current configuration.
Undo	N/A	Click the Undo button to restore configuration to previous setting before saving.

4G Vehicle Gateway

2.4 IPv6

The growth of the Internet has created a need for more addresses than are possible with IPv4. IPv6 (Internet Protocol version 6) is a version of the Internet Protocol (IP) intended to succeed IPv4, which is the protocol currently used to direct almost all Internet traffic. IPv6 also implements additional features not present in IPv4. It simplifies aspects of address assignment (stateless address auto-configuration), network renumbering and router announcements when changing Internet connectivity providers.

2.4.1 IPv6 Configuration

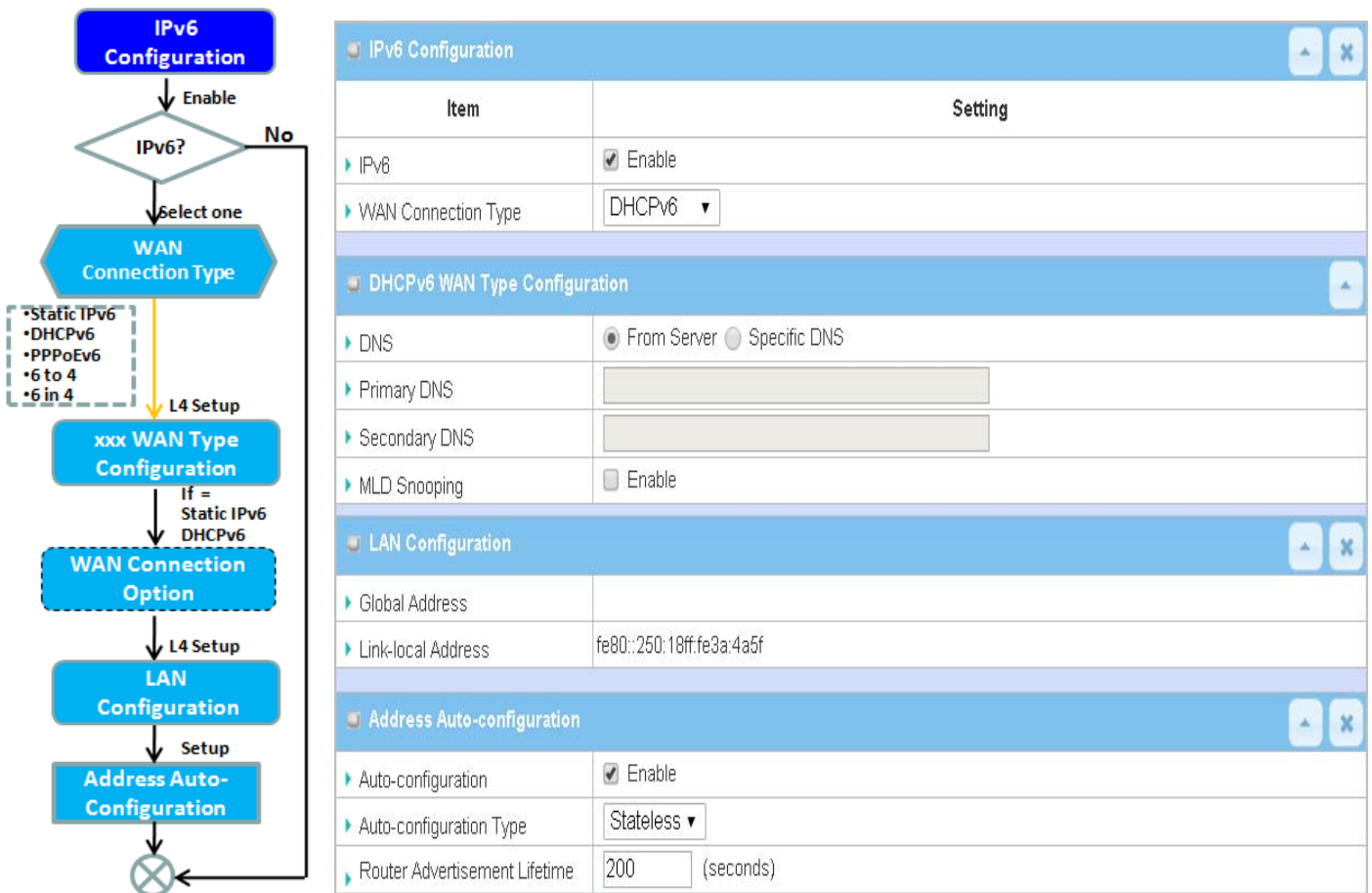

The **IPv6 Configuration** setting allows user to set the IPv6 connection type to access the IPv6 network. This gateway supports various types of IPv6 connection, including **Static IPv6**, **DHCPv6**, and **PPPoEv6**

Note: The available WAN connection types can be different, depending on the Interface type of WAN-1.

4G Vehicle Gateway

IPv6 WAN Connection Type

Static IPv6

Static IPv6 does the same function as static IPv4. The static IPv6 provides manual setting of IPv6 address, IPv6 default gateway address, and IPv6 DNS.

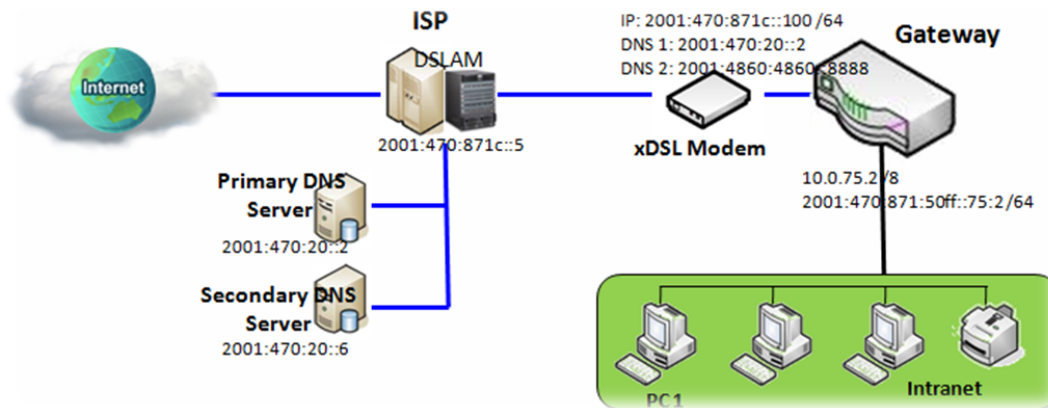

Above diagram depicts the IPv6 IP addressing, type in the information provided by your ISP to setup the IPv6 network.

DHCPv6

DHCP in IPv6 does the same function as DHCP in IPv4. The DHCP server sends IP address, DNS server addresses and other possible data to the DHCP client to configure automatically. The server also sends a lease time of the address and time to re-contact the server for IPv6 address renewal. The client has then to resend a request to renew the IPv6 address.

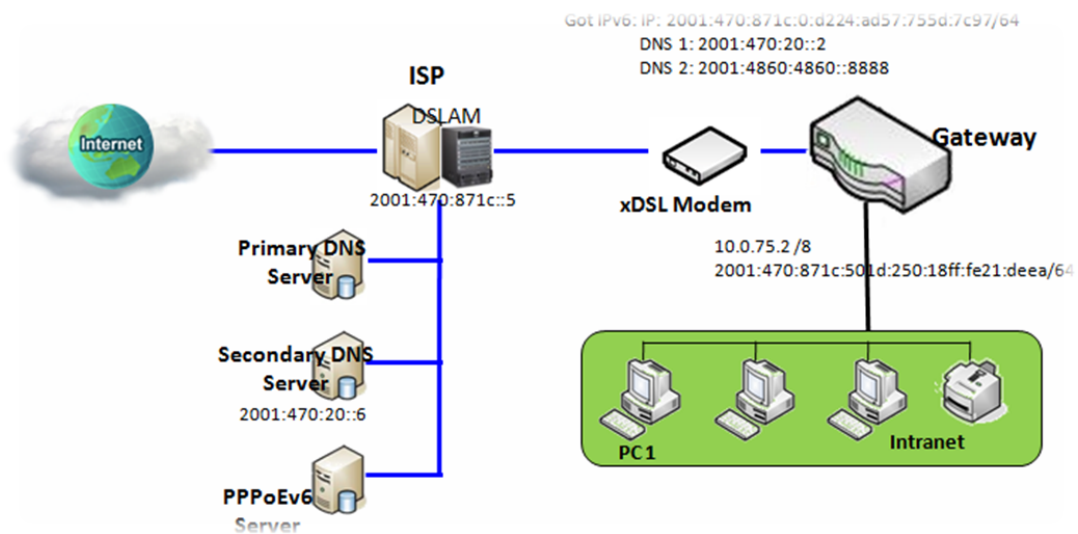

Above diagram depicts DHCP IPv6 IP addressing, the DHCPv6 server on the ISP side assigns IPv6 address, IPv6 default gateway address, and IPv6 DNS to client host's automatically.

4G Vehicle Gateway

PPPoEv6

PPPoEv6 in IPv6 does the same function as PPPoE in IPv4. The PPPoEv6 server provides configuration parameters based on PPPoEv6 client request. When PPPoEv6 server gets client request and successfully authenticates it, the server sends IP address, DNS server addresses and other required parameters to automatically configure the client.

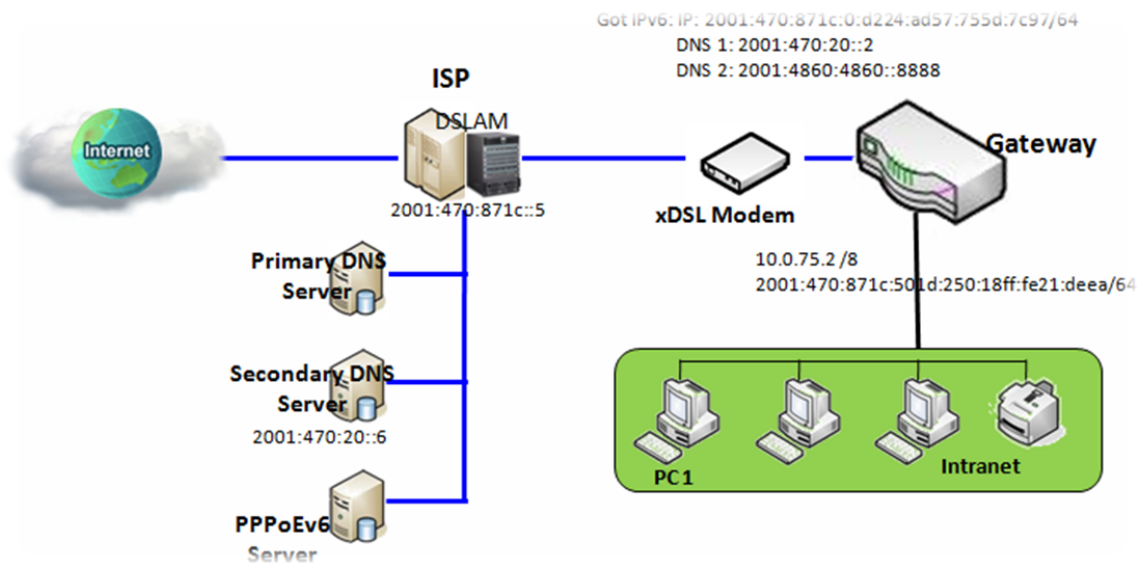

The diagram above depicts the IPv6 addressing through PPPoE, PPPoEv6 server (DSLAM) on the ISP side provides IPv6 configuration upon receiving PPPoEv6 client request. When PPPoEv6 server gets client request and successfully authenticates it, the server sends IP address, DNS server addresses and other required parameters to automatically configure the client.

4G Vehicle Gateway

IPv6 Configuration Setting

Go to **Basic Network > IPv6 > Configuration** Tab.

The **IPv6 Configuration** setting allows user to set the IPv6 connection type to access the IPv6 network.

IPv6 Configuration	
Item	Setting
▶ IPv6	<input checked="" type="checkbox"/> Enable
▶ WAN Connection Type	DHCPv6 ▾

IPv6 Configuration Item	Value setting	Description
IPv6	The box is unchecked by default,	Check the Enable box to activate the IPv6 function.
WAN Connection Type	1. A Must filled setting 2. DHCPv6 is selected by default	Define the selected IPv6 WAN Connection Type to establish the IPv6 connectivity via WAN-1 Interface. Select Static IPv6 when your ISP provides you with a set IPv6 addresses. Select DHCPv6 when your ISP provides you with DHCPv6 services. Select PPPoEv6 when your ISP provides you with PPPoEv6 account settings. Note: The available WAN connection types can be different, depending on the Interface type of WAN-1.

Static IPv6 WAN Type Configuration

Static IPv6 WAN Type Configuration	
▶ IPv6 Address	<input type="text"/>
▶ Subnet Prefix Length	<input type="text"/>
▶ Default Gateway	<input type="text"/>
▶ Primary DNS	<input type="text"/>
▶ Secondary DNS	<input type="text"/>
▶ MLD Snooping	<input type="checkbox"/> Enable

Static IPv6 WAN Type Configuration Item	Value setting	Description
IPv6 Address	A Must filled setting	Enter the WAN IPv6 Address for the router.
Subnet Prefix	A Must filled setting	Enter the WAN Subnet Prefix Length for the router.

4G Vehicle Gateway

Length		
Default Gateway	A Must filled setting	Enter the WAN Default Gateway IPv6 address.
Primary DNS	An optional setting	Enter the WAN primary DNS Server .
Secondary DNS	An optional setting	Enter the WAN secondary DNS Server .
MLD Snooping	The box is unchecked by default	Enable/Disable the MLD Snooping function

LAN Configuration

LAN Configuration

▶ Global Address	<input type="text"/>	/64
▶ Link-local Address	fe80::250:18ff:fe3a:4a5f	

LAN Configuration		
Item	Value setting	Description
Global Address	A Must filled setting	Enter the LAN IPv6 Address for the router.
Link-local Address	Value auto-created	Show the link-local address for LAN interface of router.

Then go to **Address Auto-configuration (summary)** for setting LAN environment.

If above setting is configured, click the **Save** button to save the configuration, and click the **Reboot** button to reboot the router.

4G Vehicle Gateway

DHCPv6 WAN Type Configuration

DHCPv6 WAN Type Configuration	
DNS	<input checked="" type="radio"/> From Server <input type="radio"/> Specific DNS
Primary DNS	<input type="text"/>
Secondary DNS	<input type="text"/>
MLD Snooping	<input type="checkbox"/> Enable

Item	Value setting	Description
DNS	The option [From Server] is selected by default	Select the [Specific DNS] option to active Primary DNS and Secondary DNS. Then fill the DNS information.
Primary DNS	Can not modified by default	Enter the WAN primary DNS Server .
Secondary DNS	Can not modified by default	Enter the WAN secondary DNS Server .
MLD	The box is unchecked by default	Enable/Disable the MLD Snooping function

LAN Configuration

LAN Configuration	
Global Address	<input type="text"/>
Link-local Address	fe80::250:18ff:fe3a:4a5f

Item	Value setting	Description
Global Address	Value auto-created	Enter the LAN IPv6 Address for the router.
Link-local Address	Value auto-created	Show the link-local address for LAN interface of router.

Then go to **Address Auto-configuration (summary)** for setting LAN environment.

If above setting is configured, click the **Save** button to save the configuration, and click **Reboot** button to reboot the router.

4G Vehicle Gateway

PPPoEv6 WAN Type Configuration

PPPoEv6 WAN Type Configuration	
▶ Account	<input type="text" value="admin"/>
▶ Password	<input type="password" value="....."/>
▶ Service Name	<input type="text"/>
▶ Connection Control	Auto-reconnect (Always on)
▶ MTU	<input type="text"/>
▶ MLD Snooping	<input type="checkbox"/> Enable

Item	Value setting	Description
Account	A Must filled setting	Enter the Account for setting up PPPoEv6 connection. If you want more information, please contact your ISP. Value Range: 0 ~ 45 characters.
Password	A Must filled setting	Enter the Password for setting up PPPoEv6 connection. If you want more information, please contact your ISP.
Service Name	A Must filled setting/Option	Enter the Service Name for setting up PPPoEv6 connection. If you want more information, please contact your ISP. Value Range: 0 ~ 45 characters.
Connection Control	Fixed value	The value is Auto-reconnect(Always on) .
MTU	A Must filled setting	Enter the MTU for setting up PPPoEv6 connection. If you want more information, please contact your ISP. Value Range: 1280 ~ 1492.
MLD Snooping	The box is unchecked by default	Enable/Disable the MLD Snooping function

LAN Configuration

LAN Configuration	
▶ Global Address	<input type="text"/>
▶ Link-local Address	fe80::250:18ff:fe3a:4a5f

Item	Value setting	Description
Global Address	Value auto-created	The LAN IPv6 Address for the router.
Link-local Address	Value auto-created	Show the link-local address for LAN interface of router.

Then go to **Address Auto-configuration (summary)** for setting LAN environment.

If above setting is configured, click the **save button** to save the configuration and click **reboot button** to reboot the router.

4G Vehicle Gateway

Then go to **Address Auto-configuration (summary)** for setting LAN environment.

If above setting is configured, click the **save button** to save the configuration and click **reboot button** to reboot the router.

Address Auto-configuration

Address Auto-configuration	
Auto-configuration	<input checked="" type="checkbox"/> Enable
Auto-configuration Type	Stateless ▾
Router Advertisement Lifetime	<input type="text" value="200"/> (seconds)

Address Auto-configuration		
Item	Value setting	Description
Auto-configuration	The box is unchecked by default	Check to enable the Auto configuration feature.
Auto-configuration Type	1. Only can be selected when Auto-configuration enabled 2. Stateless is selected by default	Define the selected IPv6 WAN Connection Type to establish the IPv6 connectivity. Select Stateless to manage the Local Area Network to be SLAAC + RDNSS Router Advertisement Lifetime (A Must filled setting): Enter the Router Advertisement Lifetime (in seconds). 200 is set by default. <u>Value Range:</u> 0 ~ 65535. Select Stateful to manage the Local Area Network to be Stateful (DHCPv6) . IPv6 Address Range (Start) (A Must filled setting): Enter the start IPv6 Address for the DHCPv6 range for your local computers. 0100 is set by default. <u>Value Range:</u> 0001 ~ FFFF. IPv6 Address Range (End) (A Must filled setting): Enter the end IPv6 Address for the DHCPv6 range for your local computers. 0200 is set by default. <u>Value Range:</u> 0001 ~ FFFF. IPv6 Address Lifetime (A Must filled setting): Enter the DHCPv6 lifetime for your local computers. 36000 is set by default. <u>Value Range:</u> 0 ~ 65535.

4G Vehicle Gateway

2.5 Port Forwarding

Network address translation (NAT) is a methodology of remapping one IP address space into another by modifying network address information in Internet Protocol (IP) datagram packet headers while they are in transit across a traffic routing device. The technique was originally used for ease of rerouting traffic in IP networks without renumbering every host. It has become a popular and essential tool in conserving global address space allocations in face of IPv4 address exhaustion. The product you purchased embeds and activates the NAT function. You also can disable the NAT function in **[Basic Network]-[WAN & Uplink]-[Internet Setup]-[WAN Type Configuration]** page.

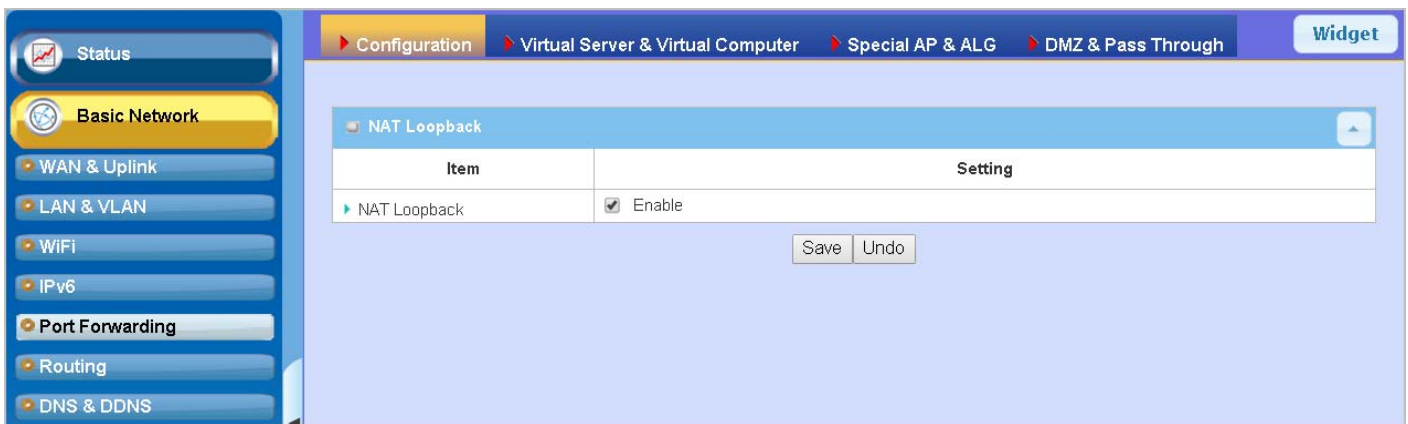

Usually all local hosts or servers behind corporate gateway are protected by NAT firewall. NAT firewall will filter out unrecognized packets to protect your Intranet. So, all local hosts are invisible to the outside world. Port forwarding or port mapping is function that redirects a communication request from one address and port number combination to assigned one. This technique is most commonly used to make services on a host residing on a protected or masqueraded (internal) network available to hosts on the opposite side of the gateway (external network), by remapping the destination IP address and port number

4G Vehicle Gateway

2.5.1 Configuration

[NAT Loopback](#)

This feature allows you to access the WAN global IP address from your inside NAT local network. It is useful when you run a server inside your network. For example, if you set a mail server at LAN side, your local devices can access this mail server through gateway's global IP address when enable NAT loopback feature. On either side are you in accessing the email server, at the LAN side or at the WAN side, you don't need to change the IP address of the mail server.

[Configuration Setting](#)

Go to **Basic Network > Port Forwarding > Configuration** tab.

The NAT Loopback allows user to access the WAN IP address from inside your local network.

Enable NAT Loopback



Item	Setting
NAT Loopback	<input checked="" type="checkbox"/> Enable

Configuration Item	Value setting	Description
NAT Loopback	The box is checked by default	Check the Enable box to activate this NAT function
Save	N/A	Click the Save button to save the settings.
Undo	N/A	Click the Undo button to cancel the settings

4G Vehicle Gateway

2.5.2 Virtual Server & Virtual Computer

The screenshot displays the configuration interface for the 4G Vehicle Gateway, divided into three main sections:

- Configuration:** A table with two columns: 'Item' and 'Setting'.

Item	Setting
Virtual Server	<input type="checkbox"/> Enable
Virtual Computer	<input checked="" type="checkbox"/> Enable
- Virtual Server List:** A table with columns: ID, WAN Interface, Server IP, Source IP, Protocol, Public Port, Private Port, Time Schedule, Enable, and Actions. It includes 'Add' and 'Delete' buttons.
- Virtual Computer List:** A table with columns: ID, Global IP, Local IP, Enable, and Actions. It includes 'Add' and 'Delete' buttons.

There are some important Port Forwarding functions implemented within the gateway, including "Virtual Server", "NAT loopback" and "Virtual Computer".

It is necessary for cooperate staffs who travel outside and want to access various servers behind office gateway. You can set up those servers by using "Virtual Server" feature. After trip, if want to access those servers from LAN side by global IP, without change original setting, NAT Loopback can achieve it.

"Virtual computer" is a host behind NAT gateway whose IP address is a global one and is visible to the outside world. Since it is behind NAT, it is protected by gateway firewall. To configure Virtual Computer, you just have to map the local IP of the virtual computer to a global IP.

4G Vehicle Gateway

Virtual Server & NAT Loopback

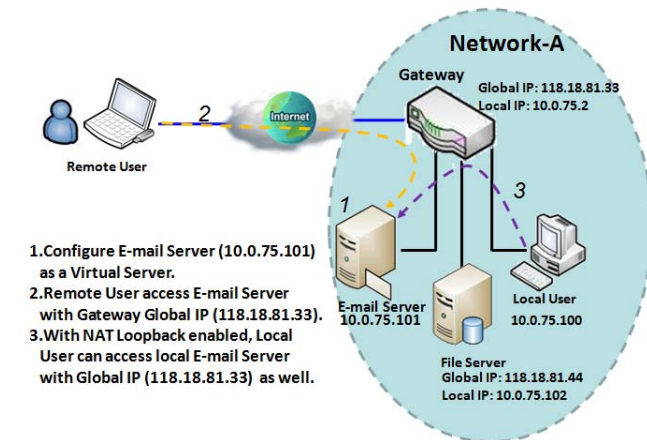

"Virtual Server" allows you to access servers with the global IP address or FQDN of the gateway as if they are servers existed in the Internet. But in fact, these servers are located in the Intranet and are physically behind the gateway. The gateway serves the service requests by port forwarding the requests to the LAN servers and transfers the replies from LAN servers to the requester on the WAN side. As shown in example, an E-mail virtual server is defined to be located at a server with IP address 10.0.75.101 in the Intranet of Network-A, including SMTP service port 25 and POP3 service port 110. So, the remote user can access the E-mail server with the

gateway's global IP 118.18.81.33 from its WAN side. But the real E-mail server is located at LAN side and the gateway is the port forwarder for E-mail service.

NAT Loopback allows you to access the WAN global IP address from your inside NAT local network. It is useful when you run a server inside your network. For example, if you set a mail server at LAN side, your local devices can access this mail server through gateway's global IP address when enable NAT loopback feature. On either side are you in accessing the email server, at the LAN side or at the WAN side, you don't need to change the IP address of the mail server.

Virtual Computer

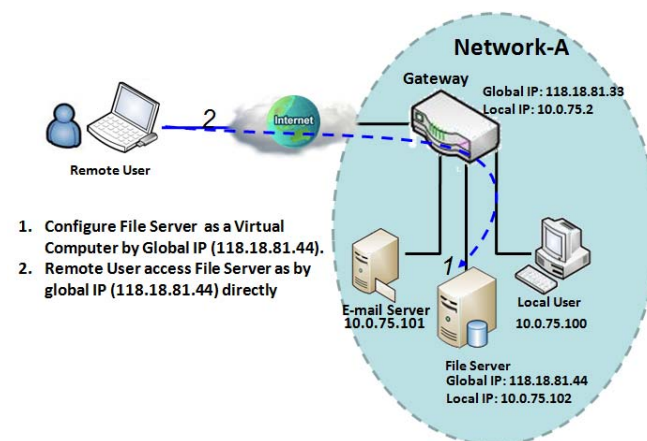

"Virtual Computer" allows you to assign LAN hosts to global IP addresses, so that they can be visible to outside world. While so, they are also protected by the gateway firewall as being client hosts in the Intranet. For example, if you set a FTP file server at LAN side with local IP address 10.0.75.102 and global IP address 118.18.82.44, a remote user can access the file server while it is hidden behind the NAT gateway. That is because the gateway takes care of all accessing to the IP address 118.18.82.44, including to forward the access requests to the file server and to send the replies from the server to outside world.

4G Vehicle Gateway

Virtual Server & Virtual Computer Setting

Go to **Basic Network > Port Forwarding > Virtual Server & Virtual Computer** tab.

Enable Virtual Server and Virtual Computer

Configuration	
Item	Setting
▶ Virtual Server	<input type="checkbox"/> Enable
▶ Virtual Computer	<input checked="" type="checkbox"/> Enable

Configuration Item	Value setting	Description
Virtual Server	The box is unchecked by default	Check the Enable box to activate this port forwarding function
Virtual Computer	The box is checked by default	Check the Enable box to activate this port forwarding function
Save	N/A	Click the Save button to save the settings.
Undo	N/A	Click the Undo button to cancel the settings.

Create / Edit Virtual Server

The gateway allows you to custom your Virtual Server rules. It supports up to a maximum of 20 rule-based Virtual Server sets.

Virtual Server List									
ID	WAN Interface	Server IP	Source IP	Protocol	Public Port	Private Port	Time Schedule	Enable	Actions

When **Add** button is applied, **Virtual Server Rule Configuration** screen will appear.

4G Vehicle Gateway

Virtual Server Rule Configuration	
Item	Setting
▶ WAN Interface	<input checked="" type="checkbox"/> All <input type="checkbox"/> WAN-1 <input type="checkbox"/> WAN-2 <input type="checkbox"/> WAN-3
▶ Server IP	<input type="text"/>
▶ Source IP	Any ▾
▶ Protocol	TCP(6) & UDP(17) ▾
▶ Public Port	Single Port ▾ <input type="text"/>
▶ Private Port	Single Port ▾ <input type="text"/>
▶ Time Schedule	(0) Always ▾
▶ Rule	<input type="checkbox"/> Enable

Virtual Server Rule Configuration		
Item	Value setting	Description
WAN Interface	<ol style="list-style-type: none"> 1. A Must filled setting 2. Default is ALL. 	<p>Define the selected interface to be the packet-entering interface of the gateway.</p> <p>If the packets to be filtered are coming from WAN-x then select WAN-x for this field.</p> <p>Select ALL for packets coming into the gateway from any interface. It can be selected WAN-x box when WAN-x enabled.</p> <p>Note: The available check boxes (WAN-1 ~ WAN-4) depend on the number of WAN interfaces for the product.</p>
Server IP	<ol style="list-style-type: none"> 1. A Must filled setting 	<p>This field is to specify the IP address of the interface selected in the WAN Interface setting above.</p>
Source IP	<ol style="list-style-type: none"> 1. A Must filled setting 2. By default Any is selected 	<p>This field is to specify the Source IP address.</p> <p>Select Any to allow the access coming from any IP addresses.</p> <p>Select Specific IP Address to allow the access coming from an IP address.</p> <p>Select IP Range to allow the access coming from a specified range of IP address.</p>
Protocol	<ol style="list-style-type: none"> 1. A Must filled setting 2. TCP & UDP is selected by default. 	<p>When "ICMPv4" is selected It means the option "Protocol" of packet filter rule is ICMPv4. Apply Time Schedule to this rule, otherwise leave it as Always. (refer to Scheduling setting under Object Definition) Then check Enable box to enable this rule.</p> <p>When "TCP" is selected It means the option "Protocol" of packet filter rule is TCP. Public Port selected a predefined port from Well-known Service, and Private Port is the same with Public Port number. Public Port is selected Single Port and specify a port number, and Private Port can be set a Single Port number. Public Port is selected Port Range and specify a port range, and Private Port can be selected Single Port or Port Range. <i>Value Range:</i> 1 ~ 65535 for Public Port, Private Port.</p>

4G Vehicle Gateway

When **“UDP”** is selected
 It means the option “Protocol” of packet filter rule is UDP.
Public Port selected a predefined port from **Well-known Service**, and **Private Port** is the same with **Public Port** number.
Public Port is selected **Single Port** and specify a port number, and **Private Port** can be set a **Single Port** number.
Public Port is selected **Port Range** and specify a port range, and **Private Port** can be selected **Single Port** or **Port Range**.
Value Range: 1 ~ 65535 for Public Port, Private Port.

When **“TCP & UDP”** is selected
 It means the option “Protocol” of packet filter rule is TCP and UDP.
Public Port selected a predefined port from **Well-known Service**, and **Private Port** is the same with **Public Port** number.
Public Port is selected **Single Port** and specify a port number, and **Private Port** can be set a **Single Port** number.
Public Port is selected **Port Range** and specify a port range, and **Private Port** can be selected **Single Port** or **Port Range**.
Value Range: 1 ~ 65535 for Public Port, Private Port.

When **“GRE”** is selected
 It means the option “Protocol” of packet filter rule is GRE.

When **“ESP”** is selected
 It means the option “Protocol” of packet filter rule is ESP.

When **“SCTP”** is selected
 It means the option “Protocol” of packet filter rule is SCTP.

When **“User-defined”** is selected
 It means the option “Protocol” of packet filter rule is User-defined.
 For **Protocol Number**, enter a port number.

Time Schedule	1. An optional filled setting 2. (0) Always Is selected by default.	Apply Time Schedule to this rule; otherwise leave it as (0) Always. (refer to Scheduling setting under Object Definition)
Rule	1. An optional filled setting 2. The box is unchecked by default.	Check the Enable box to activate the rule.
Save	N/A	Click the Save button to save the settings.
Undo	N/A	Click the X button to cancel the settings and return to previous page.

4G Vehicle Gateway

Create / Edit Virtual Computer

The gateway allows you to custom your Virtual Computer rules. It supports up to a maximum of 20 rule-based Virtual Computer sets.

Virtual Computer List Add Delete				
ID	Global IP	Local IP	Enable	Actions

When **Add** button is applied, **Virtual Computer Rule Configuration** screen will appear.

Virtual Computer Rule Configuration		
Global IP	Local IP	Enable
<input type="text"/>	<input type="text"/>	<input type="checkbox"/>

Virtual Computer Rule Configuration		
Item	Value setting	Description
Global IP	A Must filled setting	This field is to specify the IP address of the WAN IP.
Local IP	A Must filled setting	This field is to specify the IP address of the LAN IP.
Enable	N/A	Then check Enable box to enable this rule.
Save	N/A	Click the Save button to save the settings.

4G Vehicle Gateway

2.5.3 DMZ & Pass Through

DMZ (De Militarized Zone) Host is a host that is exposed to the Internet cyberspace but still within the protection of firewall by gateway device. So, the function allows a computer to execute 2-way communication for Internet games, Video conferencing, Internet telephony and other special applications. In some cases when a specific application is blocked by NAT mechanism, you can indicate that LAN computer as a DMZ host to solve this problem.

The DMZ function allows you to ask the gateway pass through all normal packets to the DMZ host behind the NAT gateway only when these packets are not expected to receive by applications in the gateway or by other client hosts in the Intranet. Certainly, the DMZ host is also protected by the gateway firewall. Activate the feature and specify the DMZ host with a host in the Intranet when needed.

Configuration	
Item	Setting
DMZ	<input checked="" type="checkbox"/> Enable <input checked="" type="checkbox"/> All <input type="checkbox"/> WAN-1 <input type="checkbox"/> WAN-2 <input type="checkbox"/> WAN-3 <input type="checkbox"/> WAN-4 DMZ Host: <input type="text" value="10.0.75.100"/>
Pass Through Enable	<input checked="" type="checkbox"/> IPSec <input checked="" type="checkbox"/> PPTP <input checked="" type="checkbox"/> L2TP

DMZ Scenario

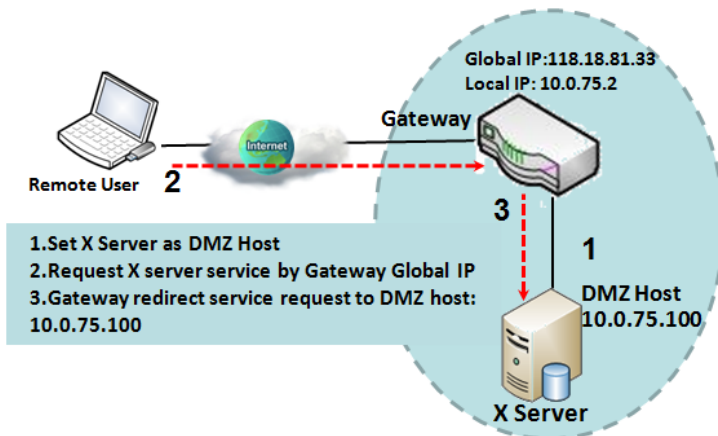

When the network administrator wants to set up some service daemons in a host behind NAT gateway to allow remote users request for services from server actively, you just have to configure this host as DMZ Host. As shown in the diagram, there is an X server installed as DMZ host, whose IP address is 10.0.75.100. Then, remote user can request services from X server just as it is provided by the gateway whose global IP address is 118.18.81.33. The gateway will forward those packets, not belonging to any configured virtual server or applications, directly to the DMZ host.

4G Vehicle Gateway

VPN Pass through Scenario

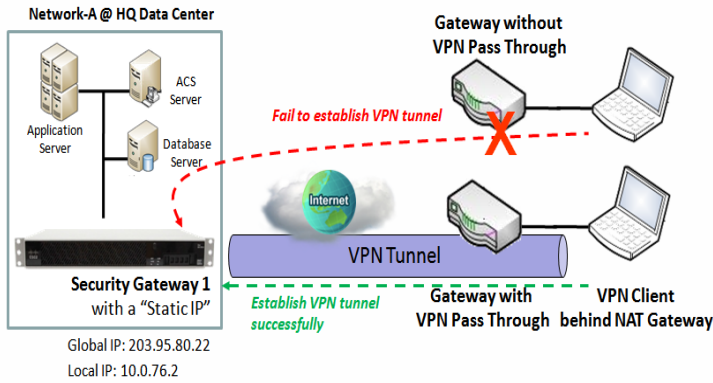

Since VPN traffic is different from that of TCP or UDP connection, it will be blocked by NAT gateway. To support the pass through function for the VPN connections initiating from VPN clients behind NAT gateway, the gateway must implement some kind of VPN pass through function for such application. The gateway support the pass through function for IPSec, PPTP, and L2TP connections, you just have to check the corresponding checkbox to activate it.

DMZ & Pass Through Setting

Go to **Basic Network > Port Forwarding > DMZ & Pass Through** tab.

The DMZ host is a host that is exposed to the Internet cyberspace but still within the protection of firewall by gateway device.

Enable DMZ and Pass Through

Configuration	
Item	Setting
DMZ	<input type="checkbox"/> Enable <input checked="" type="checkbox"/> All <input type="checkbox"/> WAN-1 <input type="checkbox"/> WAN-2 <input type="checkbox"/> WAN-3 <input type="checkbox"/> WAN-4 DMZ Host : <input type="text"/>
Pass Through Enable	<input checked="" type="checkbox"/> IPSec <input checked="" type="checkbox"/> PPTP <input checked="" type="checkbox"/> L2TP

Configuration Item	Value setting	Description
DMZ	1. A Must filled setting 2. Default is ALL .	Check the Enable box to activate the DMZ function Define the selected interface to be the packet-entering interface of the gateway, and fill in the IP address of Host LAN IP in DMZ Host field . If the packets to be filtered are coming from WAN-x then select WAN-x for this field. Select ALL for packets coming into the router from any interfaces. It can be selected WAN-x box when WAN-x enabled.

4G Vehicle Gateway

		Note: The available check boxes (WAN-1 ~ WAN-4) depend on the number of WAN interfaces for the product.
Pass Through Enable	The boxes are checked by default	Check the box to enable the pass through function for the IPSec , PPTP , and L2TP . With the pass through function enabled, the VPN hosts behind the gateway still can connect to remote VPN servers.
Save	N/A	Click the Save button to save the settings.
Undo	N/A	Click the Undo button to cancel the settings

4G Vehicle Gateway

2.5.4 Special AP & ALG

As a NAT gateway, it doesn't allow an active connection request from outside world. All this kind of requests will be ignored by the NAT gateway. But at the client hosts in the Intranet, users may use applications that need more service ports to be allowed for passing through the NAT gateway. The "Special AP (application)" feature in the gateway can solve this problem. That is, some applications require multiple connections, like Internet games, Video conferencing, Internet telephony, etc. Because of the firewall function, these applications cannot work with a pure NAT gateway. The Special AP feature allows some of these applications to work with this product.

Besides, application-level gateway (ALG) allows customized NAT traversal filters to be plugged into the gateway to support address and port translation for certain application layer "control/data" protocols such as FTP, BitTorrent, SIP, RTSP, file transfer in IM applications, etc. In order for these protocols to work through NAT or a firewall, either the application has to know about an address/port number combination that allows incoming packets, or the NAT has to monitor the control traffic and open up port mappings (firewall pinhole) dynamically as required. Legitimate application data can thus be passed through the security checks of the firewall or NAT that would have otherwise restricted the traffic for not meeting its limited filter criteria.

Special AP

ID	WAN Interface	Trigger Port	Incoming Ports	Time Schedule	Enable	Actions
1	ALL	554	6970-6999	(0) Always	<input checked="" type="checkbox"/>	Edit <input type="checkbox"/> Select
2	ALL	47624	2300-2400,28800-29000	(0) Always	<input checked="" type="checkbox"/>	Edit <input type="checkbox"/> Select

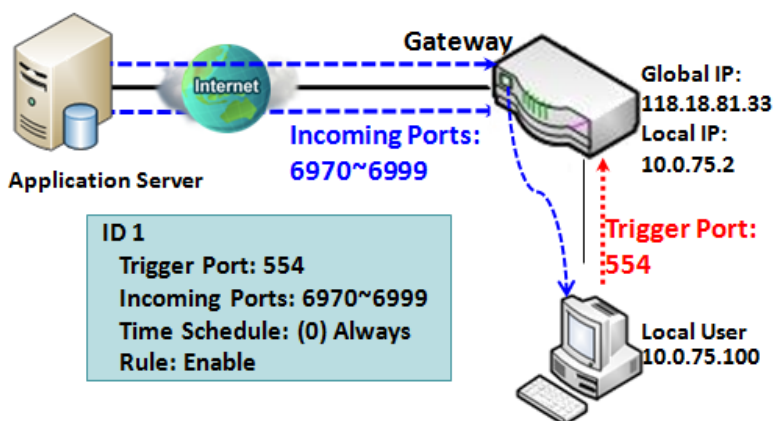

The Special AP feature allows you to request the gateway open a pre-defined service ports for incoming packets to pass through once the trigger port is activated by local hosts. As shown in the diagram, special AP rule define port 554 as trigger port and 6970~6999 as incoming ports. With such setting, local user at host 10.0.75.100 can enjoy the music by using Quick Time application, whose media server is located in the Internet. When you open application, it will activate Trigger Port and then incoming

data packet from remote application server will pass through incoming port 6970~6999.

4G Vehicle Gateway

SIP ALG

This gateway supports the SIP ALG feature to allow one SIP phone behind the NAT gateway can call another SIP phone in the Internet, even the gateway executes its NAT mechanism between the Intranet and the Internet. The NAT gateway monitors the control traffic and open up port mappings (firewall pinhole) dynamically as required to know about an address/port number combination that allows incoming packets, so it will support address and port translation for SIP application layer "control/data" protocols as shown in following diagram. The NAT Gateway enables the SIP ALG feature, so it will monitor the SIP Phone #1 actions, open up the required ports and make the address and port translation in a SIP voice communication.

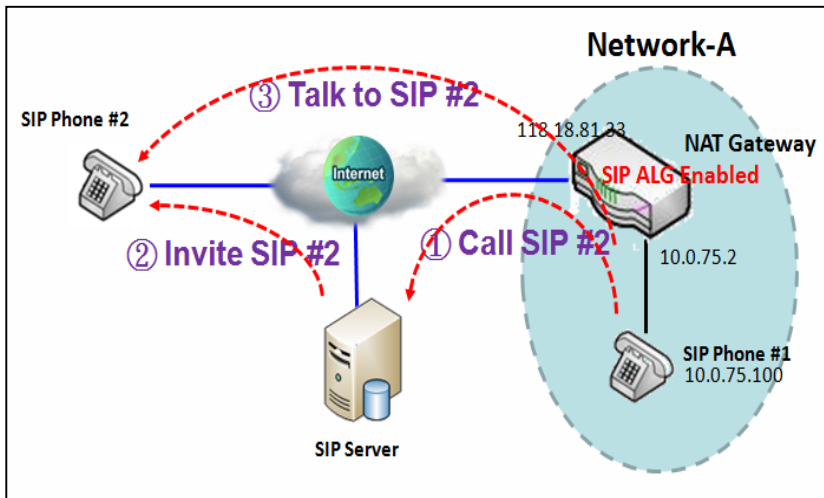

As shown in the diagram, the calling starts from the SIP Phone #1 to the SIP server via the NAT gateway. Then the SIP server invites the SIP Phone #2 and finally, the SIP Phone #1 talks to the SIP Phone #2. But for the NAT gateway, SIP Phone #2 is an unknown host, so the active access from the Phone #2 will be treated as unexpected traffic and will be blocked out. With the SIP ALG function enabled, the NAT gateway will monitor the control traffic for the SIP calls, and recognized the traffic from SIP Phone #2 is part of the connection sessions with SIP Phone #1.

4G Vehicle Gateway

Special AP & ALG Setting

Go to **Basic Network > Port Forwarding > Special AP & ALG** tab.

The Special AP setting allows some applications require multiple connections. The ALG setting allows user to Support some SIP ALG, like STUN.

Enable Special AP & ALG

Configuration	
Item	Setting
▶ Special AP	<input checked="" type="checkbox"/> Enable
▶ ALG Enable	<input checked="" type="checkbox"/> SIP ALG

Configuration Item	Value setting	Description
Special AP	The box is checked by default	Check the Enable box to activate the Special AP function.
ALG Enable	The box is checked by default	Check the Enable box to activate the SIP ALG function.
Save	N/A	Click the Save button to save the settings.
Undo	N/A	Click the Undo button to cancel the settings

Create / Edit Special AP Rule

The gateway allows you to custom your Special AP rules. It supports up to a maximum of 8 rule-based Special AP sets.

Special AP List						
ID	WAN Interface	Trigger Port	Incoming Ports	Time Schedule	Enable	Actions

When **Add** button is applied, **Special AP Rule Configuration** screen will appear.

4G Vehicle Gateway

Special AP Rule Configuration
⏪ ⏩ ✕

Item	Setting
▶ WAN Interface	<input checked="" type="checkbox"/> ALL <input type="checkbox"/> WAN-1 <input type="checkbox"/> WAN-2 <input type="checkbox"/> WAN-3 <input type="checkbox"/> WAN-4
▶ Trigger Port	Port : <input type="text"/> Popular Applications : User-defined ▼
▶ Incoming Ports	<input type="text"/>
▶ Time Schedule	(0) Always ▼
▶ Rule	<input type="checkbox"/>

Special AP Rule Configuration		
Item	Value setting	Description
WAN Interface	1. A Must filled setting 2. All is checked by default.	Check the interface box(es) to apply the Special AP rule. By default, All is checked, and the Special AP rule will be applied to all WAN interfaces.
Trigger Port	1. A Must filled setting 2. User-defined is selected by default.	Enter the expected trigger port (or port range) if User-defined is selected in the dropdown list. If you select other popular application from the dropdown list, the corresponding trigger port(s) and incoming ports will be defined automatically. Value Range: 1 ~ 65535.
Incoming Ports	1. A Must filled setting	Enter the expected Incoming ports if User-defined is selected in the Trigger Port dropdown list. If you select other popular application from the dropdown list, the corresponding incoming ports will be defined automatically. Value Range: 1 ~ 65535; It can be a single port, multiple ports separated by “,”, .or port range.
Time Schedule	1. An Must filled setting 2. (0) Always is selected by default.	Apply Time Schedule to this rule, otherwise leave it as Always. If the dropdown list is empty ensure Time Schedule is pre-configured. Refer to Object Definition > Scheduling > Configuration tab.
Rule	The box is unchecked by default	Check the Enable box to activate the special AP rule.
Save	N/A	Click the Save button to save the settings.
Undo	N/A	Click the Undo button to cancel the settings

4G Vehicle Gateway

2.6 Routing



If you have more than one router and subnet, you will need to enable routing function to allow packets to find proper routing path and allow different subnets to communicate with each other. Routing is the process of selecting best paths in a network. It is performed for many kinds of networks, like electronic data networks (such as the Internet), by using packet switching technology. The routing process usually directs forwarding on the basis of routing tables which maintain a record of the routes to various network destinations. Thus, constructing routing tables, which are held in the router's memory, is very important for efficient routing. Most routing algorithms use only one network path at a time.

The routing tables record your pre-defined routing paths for some specific destination subnets. It is **static routing**. However, if the contents of routing tables record the obtained routing paths from neighbor routers by using some protocols, such as RIP, OSPF and BGP. It is **dynamic routing**. These both routing approaches will be illustrated one after one. In addition, the gateway also built in one advanced configurable routing software Quagga for more complex routing applications, you can configure it if required via Telnet CLI.

4G Vehicle Gateway

2.6.1 Static Routing

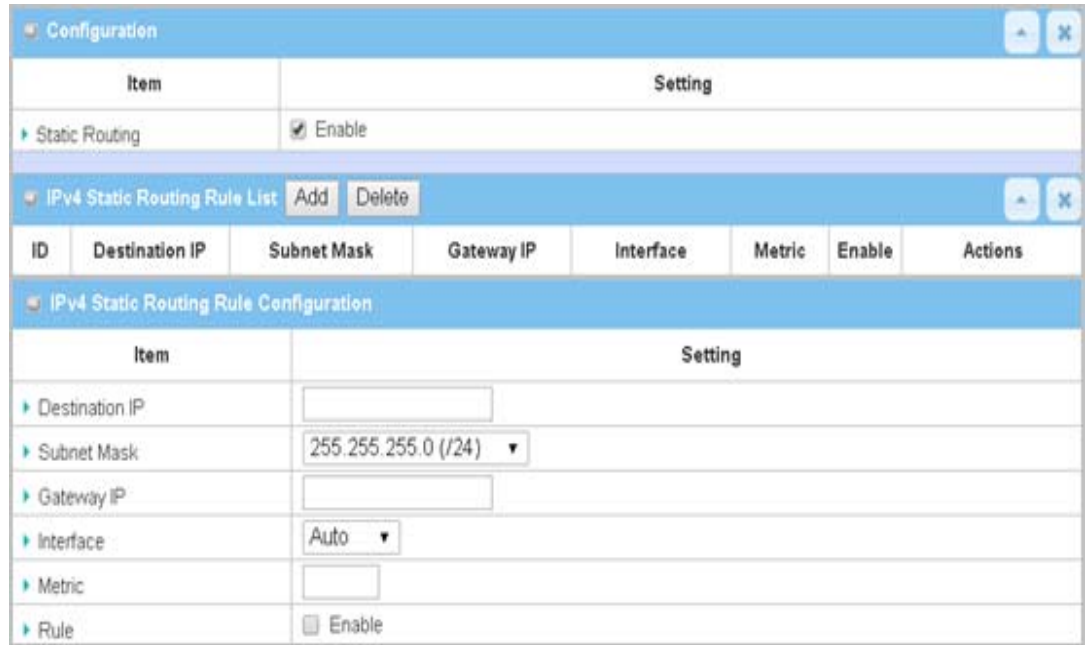
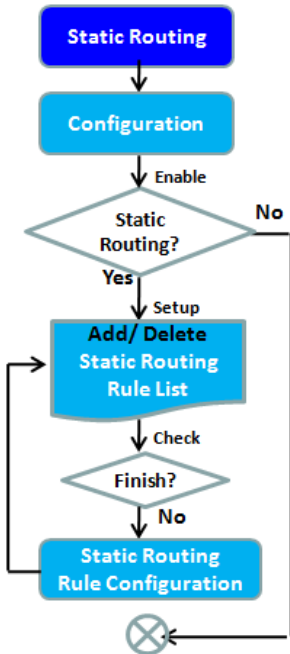

"Static Routing" function lets you define the routing paths for some dedicated hosts/servers or subnets to store in the routing table of the gateway. The gateway routes incoming packets to different peer gateways based on the routing table. You need to define the static routing information in gateway routing rule list.

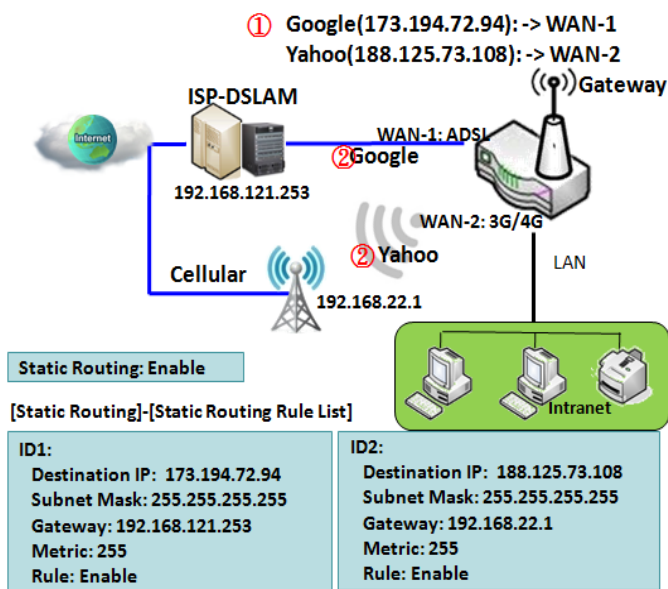

When the administrator of the gateway wants to specify what kinds of packets to be transferred via which gateway interface and which peer gateway to their destination. It can be carried out by the "Static Routing" feature. Dedicated packet flows from the Intranet will be routed to their destination via the pre-defined peer gateway and corresponding gateway interface that are defined in the system routing table by manual.

As shown in the diagram, when the destination is Google access, rule 1 set interface as ADSL, routing gateway as IP-DSLAM gateway 192.168.121.253. All the packets to Google will go through WAN-1. And the same way applied to rule 2 of access Yahoo. Rule 2 sets 3G/4G as interface.

4G Vehicle Gateway

Static Routing Setting

Go to **Basic Network > Routing > Static Routing** Tab.

There are three configuration windows for static routing feature, including "Configuration", "Static Routing Rule List" and "Static Routing Rule Configuration" windows. "Configuration" window lets you activate the global static routing feature. Even there are already routing rules, if you want to disable routing temporarily, just uncheck the Enable box to disable it. "Static Routing Rule List" window lists all your defined static routing rule entries. Using "Add" or "Edit" button to add and create one new static routing rule or to modify an existed one.

When "Add" or "Edit" button is applied, the "Static Routing Rule Configuration" window will appear to let you define a static routing rule.

Enable Static Routing

Just check the **Enable** box to activate the "Static Routing" feature.



Item	Setting
Static Routing	<input checked="" type="checkbox"/> Enable

Static Routing Item	Value setting	Description
Static Routing	The box is unchecked by default	Check the Enable box to activate this function

Create / Edit Static Routing Rules

The Static Routing Rule List shows the setup parameters of all static routing rule entries. To configure a static routing rule, you must specify related parameters including the destination IP address and subnet mask of dedicated host/server or subnet, the IP address of peer gateway, the metric and the rule activation.



ID	Destination IP	Subnet Mask	Gateway IP	Interface	Metric	Enable	Actions
----	----------------	-------------	------------	-----------	--------	--------	---------

The gateway allows you to custom your static routing rules. It supports up to a maximum of 64 rule sets. When **Add** button is applied, **Static Routing Rule Configuration** screen will appear, while the **Edit** button at the end

4G Vehicle Gateway

of each static routing rule can let you modify the rule.

IPv4 Static Routing Rule Configuration	
Item	Setting
▶ Destination IP	<input type="text"/>
▶ Subnet Mask	255.255.255.0 (/24) ▼
▶ Gateway IP	<input type="text"/>
▶ Interface	Auto ▼
▶ Metric	<input type="text"/>
▶ Rule	<input type="checkbox"/> Enable

IPv4 Static Routing		
Item	Value setting	Description
Destination IP	1. IPv4 Format 2. A Must filled setting	Specify the Destination IP of this static routing rule.
Subnet Mask	255.255.255.0 (/24) is set by default	Specify the Subnet Mask of this static routing rule.
Gateway IP	1. IPv4 Format 2. A Must filled setting	Specify the Gateway IP of this static routing rule.
Interface	Auto is set by default	Select the Interface of this static routing rule. It can be Auto , or the available WAN / LAN interfaces.
Metric	1. Numeric String Format 2. A Must filled setting	The Metric of this static routing rule. <i>Value Range: 0 ~ 255.</i>
Rule	The box is unchecked by default.	Click Enable box to activate this rule.
Save	NA	Click the Save button to save the configuration
Undo	NA	Click the Undo button to restore what you just configured back to the previous setting.
Back	NA	When the Back button is clicked the screen will return to the Static Routing Configuration page.

4G Vehicle Gateway

2.6.2 Dynamic Routing

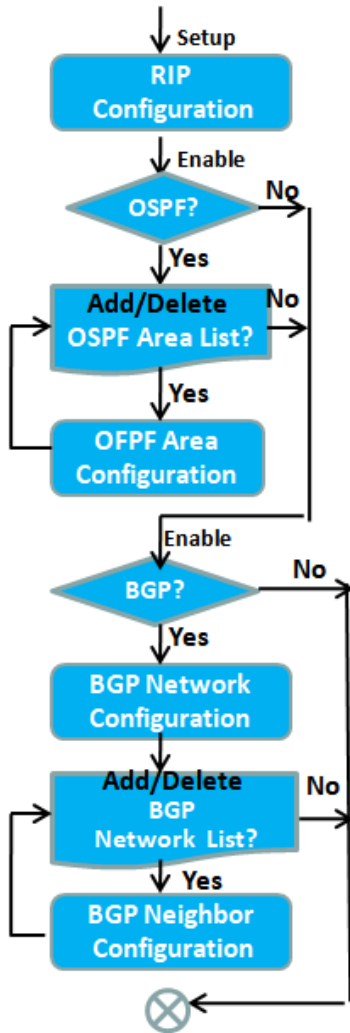

RIP Configuration	
Item	Setting
RIP Enable	Disable

OSPF Configuration	
Item	Setting
OSPF	<input type="checkbox"/> Enable
Router ID	
Authentication	None
Backbone Subnet	

OSPF Area List				
ID	Area Subnet	Area ID	Enable	Actions

OSPF Area Configuration	
Item	Setting
Area Subnet	
Area ID	
Area	<input type="checkbox"/> Enable

Save

BGP Configuration	
Item	Setting
BGP	<input type="checkbox"/> Enable
ASN	
Router ID	

BGP Network List				
ID	Network Subnet	Enable	Actions	

BGP Neighbor List				
ID	Neighbor IP	Remote ASN	Enable	Actions

Dynamic Routing, also called adaptive routing, describes the capability of a system, through which routes are characterized by their destination, to alter the path that the route takes through the system in response to a change in network conditions.

This gateway supports dynamic routing protocols, including RIPv1/RIPv2 (Routing Information Protocol), OSPF (Open Shortest Path First), and BGP (Border Gateway Protocol), for you to establish routing table automatically. The feature of dynamic routing will be very useful when there are lots of subnets in your network. Generally speaking, RIP is suitable for small network. OSPF is more suitable for medium network. BGP is more used for big network infrastructure.

4G Vehicle Gateway

The supported dynamic routing protocols are described as follows.

RIP Scenario

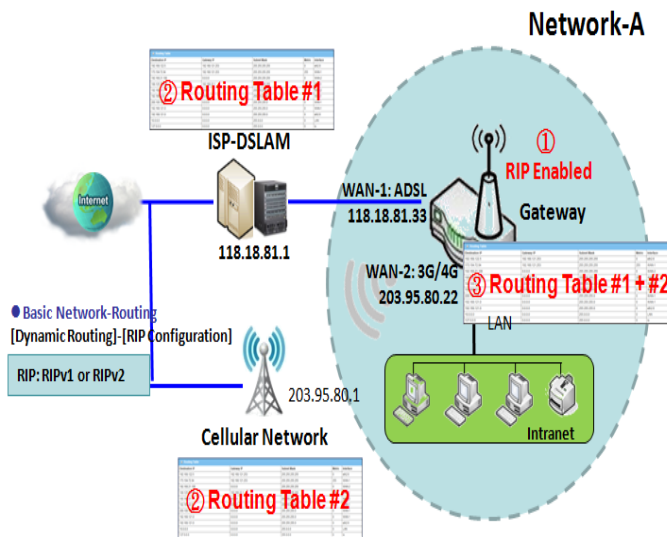

The Routing Information Protocol (RIP) is one of the oldest distance-vector routing protocols, which employs the hop count as a routing metric. RIP prevents routing loops by implementing a limit on the number of hops allowed in a path from the source to a destination. The maximum number of hops allowed for RIP is 15. This hop limit, however, also limits the size of networks that RIP can support. A hop count of 16 is considered an infinite distance, in other words the route is considered unreachable. RIP implements the split horizon, route poisoning and hold-down mechanisms to prevent incorrect routing information from being propagated.

OSPF Scenario

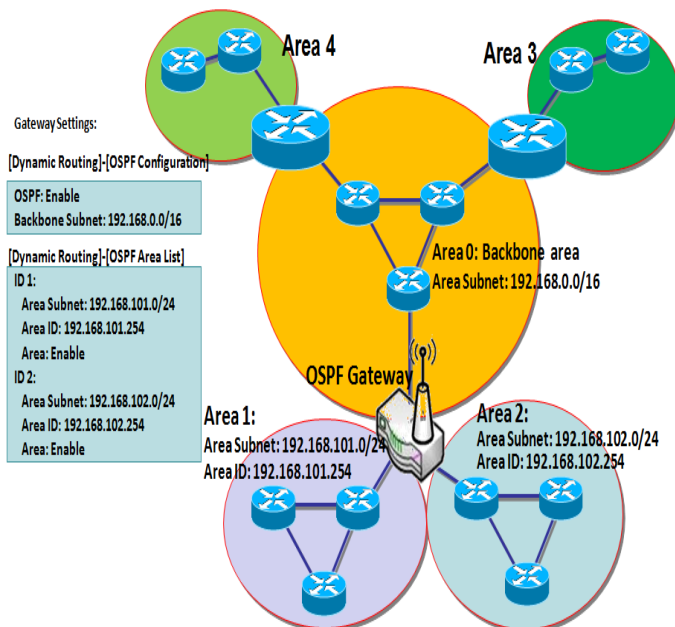

Open Shortest Path First (OSPF) is a routing protocol that uses link state routing algorithm. It is the most widely used interior gateway protocol (IGP) in large enterprise networks. It gathers link state information from available routers and constructs a topology map of the network. The topology is presented as a routing table which routes datagrams based solely on the destination IP address.

Network administrator can deploy OSPF gateway in large enterprise network to get its routing table from the enterprise backbone, and forward routing information to other routers, which are no linked to the enterprise backbone. Usually, an OSPF network is subdivided into routing areas to simplify administration and optimize traffic and resource utilization.

As shown in the diagram, OSPF gateway gathers routing information from the backbone gateways in area 0, and will forward its routing information to the routers in area 1 and area 2 which are not in the backbone.

4G Vehicle Gateway

BGP Scenario

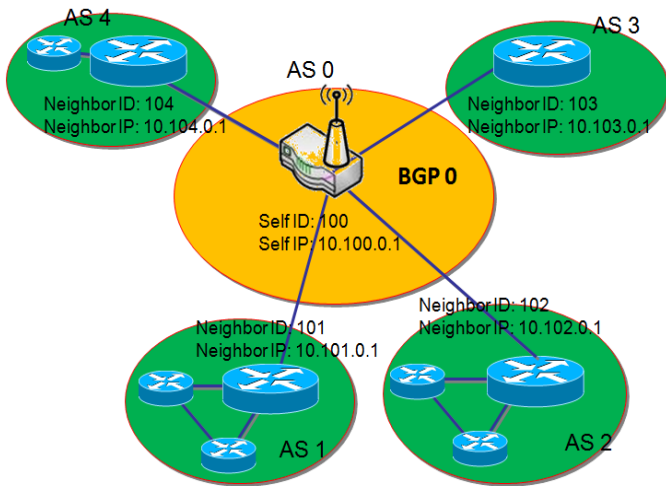

Border Gateway Protocol (BGP) is a standard exterior gateway protocol designed to exchange routing and reachability information between autonomous systems (AS) on the Internet. It usually makes routing decisions based on paths, network policies, or rule-sets.

Most ISPs use BGP to establish routing between one another (especially for multi-homed). Very large private IP networks also use BGP internally. The major BGP gateway within one AS will link with some other border gateways for exchanging routing information. It will distribute the collected data in AS to all routers in other AS.

As shown in the diagram, BGP 0 is gateway to dominate AS 0 (self IP is 10.100.0.1 and self ID is 100). It links with other BGP gateways in the Internet. The scenario is like Subnet in one ISP to be linked with the ones in other ISPs. By operating with BGP protocol, BGP 0 can gather routing information from other BGP gateways in the Internet. And then it forwards the routing data to the routers in its dominated AS. Finally, the routers resided in AS 0 know how to route packets to other AS.

4G Vehicle Gateway

Dynamic Routing Setting

Go to **Basic Network > Routing > Dynamic Routing** Tab.

The dynamic routing setting allows user to customize RIP, OSPF, and BGP protocol through the router based on their office setting.

In the "Dynamic Routing" page, there are several configuration windows for dynamic routing feature. They are the "RIP Configuration" window, "OSPF Configuration" window, "OSPF Area List", "OSPF Area Configuration", "BGP Configuration", "BGP Neighbor List" and "BGP Neighbor Configuration" window. RIP, OSPF and BGP protocols can be configured individually.

The "RIP Configuration" window lets you choose which version of RIP protocol to be activated or disable it. The "OSPF Configuration" window can let you activate the OSPF dynamic routing protocol and specify its backbone subnet. Moreover, the "OSPF Area List" window lists all defined areas in the OSPF network. However, the "BGP Configuration" window can let you activate the BGP dynamic routing protocol and specify its self ID. The "BGP Neighbor List" window lists all defined neighbors in the BGP network.

RIP Configuration

The RIP configuration setting allows user to customize RIP protocol through the router based on their office setting.



Item	Setting
RIP Enable	Disable

RIP Configuration		
Item	Value setting	Description
RIP Enable	Disable is set by default	Select Disable will disable RIP protocol. Select RIP v1 will enable RIPv1 protocol. Select RIP v2 will enable RIPv2 protocol.

OSPF Configuration

The OSPF configuration setting allows user to customize OSPF protocol through the router based on their office setting.

4G Vehicle Gateway

OSPF Configuration	
Item	Setting
▶ OSPF	<input type="checkbox"/> Enable
▶ Router ID	<input type="text"/>
▶ Authentication	None ▾
▶ Backbone Subnet	<input type="text"/>

OSPF Configuration		
Item	Value setting	Description
OSPF	Disable is set by default	Click Enable box to activate the OSPF protocol.
Router ID	1. IPv4 Format 2. A Must filled setting	The Router ID of this router on OSPF protocol
Authentication	None is set by default	The Authentication method of this router on OSPF protocol. Select None will disable Authentication on OSPF protocol. Select Text will enable Text Authentication with entered the Key in this field on OSPF protocol. Select MD5 will enable MD5 Authentication with entered the ID and Key in these fields on OSPF protocol.
Backbone Subnet	1. Classless Inter Domain Routing (CIDR) Subnet Mask Notation. (Ex: 192.168.1.0/24) 2. A Must filled setting	The Backbone Subnet of this router on OSPF protocol.

Create / Edit OSPF Area Rules

The gateway allows you to custom your OSPF Area List rules. It supports up to a maximum of 32 rule sets.

OSPF Area List Add Delete				
ID	Area Subnet	Area ID	Enable	Actions

When **Add** button is applied, **OSPF Area Rule Configuration** screen will appear.

4G Vehicle Gateway

OSPF Area Configuration
▲ ✕

Item	Setting
▶ Area Subnet	<input type="text"/>
▶ Area ID	<input type="text"/>
▶ Area	<input type="checkbox"/> Enable
<input type="button" value="Save"/>	

OSPF Area Configuration		
Item	Value setting	Description
Area Subnet	1. Classless Inter Domain Routing (CIDR) Subnet Mask Notation. (Ex: 192.168.1.0/24) 2. A Must filled setting	The Area Subnet of this router on OSPF Area List.
Area ID	1. IPv4 Format 2. A Must filled setting	The Area ID of this router on OSPF Area List.
Area	The box is unchecked by default.	Click Enable box to activate this rule.
Save	N/A	Click the Save button to save the configuration

4G Vehicle Gateway

BGP Configuration

The BGP configuration setting allows user to customize BGP protocol through the router setting.

BGP Configuration	
Item	Setting
BGP	<input type="checkbox"/> Enable
ASN	<input type="text"/>
Router ID	<input type="text"/>

BGP Network Configuration		
Item	Value setting	Description
BGP	The box is unchecked by default	Check the Enable box to activate the BGP protocol.
ASN	1. Numeric String Format 2. A Must filled setting	The ASN Number of this router on BGP protocol. Value Range: 1 ~ 4294967295.
Router ID	1. IPv4 Format 2. A Must filled setting	The Router ID of this router on BGP protocol.

Create / Edit BGP Network Rules

The gateway allows you to custom your BGP Network rules. It supports up to a maximum of 32 rule sets.

BGP Network List			
ID	Network Subnet	Enable	Actions

When **Add** button is applied, **BGP Network Configuration** screen will appear.

BGP Network Configuration	
Item	Setting
Network Subnet	IP : <input type="text"/> 255.255.255.0 (/24)
Network	<input type="checkbox"/> Enable
<input type="button" value="Save"/>	

Item	Value setting	Description
Network Subnet	1. IPv4 Format	The Network Subnet of this router on BGP Network List. It composes of entered

4G Vehicle Gateway

	2. A Must filled setting	the IP address in this field and the selected subnet mask.
Network	The box is unchecked by default.	Click Enable box to activate this rule.
Save	N/A	Click the Save button to save the configuration

Create / Edit BGP Neighbor Rules

The gateway allows you to custom your BGP Neighbor rules. It supports up to a maximum of 32 rule sets.

BGP Neighbor List
Add
Delete
▲

ID	Neighbor IP	Remote ASN	Enable	Actions
----	-------------	------------	--------	---------

When **Add** button is applied, **BGP Neighbor Configuration** screen will appear.

BGP Neighbor Configuration
▲ ✕

Item	Setting
▶ Neighbor IP	<input style="width: 90%;" type="text"/>
▶ Remote ASN	<input style="width: 90%;" type="text"/>
▶ Neighbor	<input type="checkbox"/> Enable

Save

BGP Neighbor Configuration		
Item	Value setting	Description
Neighbor IP	1. IPv4 Format 2. A Must filled setting	The Neighbor IP of this router on BGP Neighbor List.
Remote ASN	1. Numeric String Format 2. A Must filled setting	The Remote ASN of this router on BGP Neighbor List. Value Range: 1 ~ 4294967295.
Neighbor	The box is unchecked by default.	Click Enable box to activate this rule.
Save	N/A	Click the Save button to save the configuration

4G Vehicle Gateway

2.6.3 Routing Information

The routing information allows user to view the routing table and policy routing information. Policy Routing Information is only available when the Load Balance function is enabled and the Load Balance Strategy is By User Policy.

Go to **Basic Network > Routing > Routing Information** Tab.

Routing Table				
Destination IP	Subnet Mask	Gateway IP	Metric	Interface
100.105.167.72	255.255.255.252	0.0.0.0	0	WAN-2
192.168.66.0	255.255.255.0	0.0.0.0	0	LAN
192.168.127.0	255.255.255.0	0.0.0.0	0	WAN-1
169.254.0.0	255.255.0.0	0.0.0.0	0	LAN
127.0.0.0	255.0.0.0	0.0.0.0	0	lo

Routing Table		
Item	Value setting	Description
Destination IP	N/A	Routing record of Destination IP. IPv4 Format.
Subnet Mask	N/A	Routing record of Subnet Mask. IPv4 Format.
Gateway IP	N/A	Routing record of Gateway IP. IPv4 Format.
Metric	N/A	Routing record of Metric. Numeric String Format.
Interface	N/A	Routing record of Interface Type. String Format.

Policy Routing Information				
Policy Routing Source	Source IP	Destination IP	Destination Port	WAN Interface
Load Balance	-	-	-	-

Policy Routing Information		
Item	Value setting	Description
Policy Routing Source	N/A	Policy Routing of Source. String Format.
Source IP	N/A	Policy Routing of Source IP. IPv4 Format.
Destination IP	N/A	Policy Routing of Destination IP. IPv4 Format.
Destination Port	N/A	Policy Routing of Destination Port. String Format.
WAN Interface	N/A	Policy Routing of WAN Interface. String Format.

4G Vehicle Gateway

2.7 DNS & DDNS

How does user access your server if your WAN IP address changes all the time? One way is to register a new domain name, and maintain your own DNS server. Another simpler way is to apply a domain name to a third-party DDNS service provider. The service can be free or charged. If you want to understand the basic concepts of DNS and Dynamic DNS, you can refer to Wikipedia website^{8,9}.

2.7.1 DNS & DDNS Configuration

Dynamic DNS

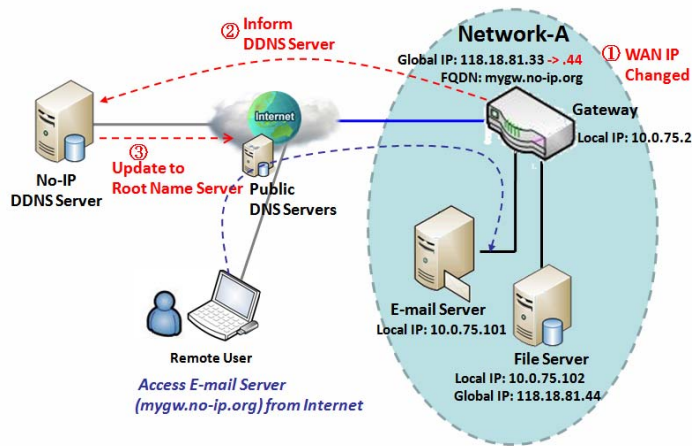

To host your server on a changing IP address, you have to use dynamic domain name service (DDNS). Therefore, anyone wishing to reach your host only needs to know the domain name. Dynamic DNS will map the name of your host to your current IP address, which changes each time you connect your Internet service provider.

The Dynamic DNS service allows the gateway to alias a public dynamic IP address to a static domain name, allowing the gateway to be more easily accessed from various locations on the Internet. As shown in the diagram, user registered a domain

name to a third-party DDNS service provider (NO-IP) to use DDNS function. Once the IP address of designated WAN interface has changed, the dynamic DNS agent in the gateway will inform the DDNS server with the new IP address. The server automatically re-maps your domain name with the changed IP address. So, other hosts or remote users in the Internet world are able to link to your gateway by using your domain name regardless of the changing global IP address.

8 http://en.wikipedia.org/wiki/Domain_Name_System

9 http://en.wikipedia.org/wiki/Dynamic_DNS

4G Vehicle Gateway

DNS & DDNS Setting

Go to **Basic Network > DNS & DDNS > Configuration** Tab.

The DNS & DDNS setting allows user to setup Dynamic DNS feature and DNS redirect rules.

Setup Dynamic DNS

The gateway allows you to custom your Dynamic DNS settings.

Dynamic DNS	
Item	Setting
▶ DDNS	<input type="checkbox"/> Enable
▶ WAN Interface	WAN-1
▶ Provider	DynDNS.org(Dynamic)
▶ Host Name	<input type="text"/>
▶ User Name / E-Mail	<input type="text"/>
▶ Password / Key	<input type="text"/>

DDNS (Dynamic DNS) Configuration		
Item	Value setting	Description
DDNS	The box is unchecked by default	Check the Enable box to activate this function.
WAN Interface	WAN 1 is set by default	Select the WAN Interface IP Address of the gateway.
Provider	DynDNS.org (Dynamic) is set by default	Select your DDNS provider of Dynamic DNS. It can be DynDNS.org(Dynamic) , DynDNS.org(Custom) , NO-IP.com , etc...
Host Name	1. String format can be any text 2. A Must filled setting	Your registered host name of Dynamic DNS. Value Range: 0 ~ 63 characters.
User Name / E-Mail	1. String format can be any text 2. A Must filled setting	Enter your User name or E-mail addresss of Dynamic DNS.
Password / Key	1. String format can be any text 2. A Must filled setting	Enter your Password or Key of Dynamic DNS.
Save	N/A	Click Save to save the settings
Undo	N/A	Click Undo to cancel the settings

4G Vehicle Gateway

Setup DNS Redirect

DNS redirect is a special function to redirect certain traffics to a specified host. Administator can manage the internet / intranet traffics that are going to access some restricted DNS and force those traffics to be redirected to a specified host.

DNS Redirect	
Item	Setting
▶ DNS Redirect	<input type="checkbox"/> Enable

DNS Redirect Configuration		
Item	Value setting	Description
DNS Redirect	The box is unchecked by default	Check the Enable box to activate this function.
Save	N/A	Click Save to save the settings
Undo	N/A	Click Undo to cancel the settings

If you enabled the DNS Redirect function, you have to further specify the redirect rules. According to the rules, the gateway can redirect the traffic that matched the DNS to corresponding pre-defined IP address.

Redirect Rule					
ID	Mapping Rule	Condition	Description	Enable	Action

When **Add** button is applied, **Redirect Rule** screen will appear.

Redirect Rule					
Item	Setting				
Mapping Rule	<table border="1"> <thead> <tr> <th>Domain Name</th> <th>IP</th> </tr> </thead> <tbody> <tr> <td><input type="text"/> (* for Any)</td> <td><input type="text"/></td> </tr> </tbody> </table>	Domain Name	IP	<input type="text"/> (* for Any)	<input type="text"/>
Domain Name	IP				
<input type="text"/> (* for Any)	<input type="text"/>				
Condition	Always				
Description	<input type="text"/>				
Enable	<input type="checkbox"/> Enable				

Redirect Rule Configuration		
Item	Value setting	Description
Domain Name	1. String format can be any text	Enter a domain name to be redirect. The traffic to specified domain name will be redirect to the following IP address.

4G Vehicle Gateway

	2. A Must filled setting	<i>Value Range:</i> at least 1 character is required; '*' for any.
IP	1. IPv4 format 2. A Must filled setting	Enter an IP Address as the target for the DNS redirect.
Condition	1. A Must filled setting 2. Always is selected by default.	Specify when will the DNS redirect action can be applied. It can be Always , or WAN Block . Always: The DNS redirect function can be applied to matched DNS all the time. WAN Block: The DNS redirect function can be applied to matched DNS only when the WAN connection is disconnected, or un-reachable.
Description	1. String format can be any text 2. A Must filled setting	Enter a brief description for this rule. <i>Value Range:</i> 0 ~ 63 characters.
Enable	The box is unchecked by default	Click the Enable button to activate this rule.
Save	N/A	Click Save to save the settings
Undo	N/A	Click Undo to cancel the settings

4G Vehicle Gateway

2.8 QoS

The total amount of data traffic increases nowadays as the higher demand of mobile applications, like Game / Chat / VoIP / P2P / Video / Web access. In order to pose new requirements for data transport, e.g. low latency, low data loss, the entire network must ensure them via a connection service guarantee.

The main goal of QoS (Quality of Service) is prioritizing incoming data, and preventing data loss due to factors such as jitter, delay and dropping. Another important aspect of QoS is ensuring that prioritizing one data flow doesn't interfere with other data flows. So, QoS helps to prioritize data as it enters your router. By attaching special identification marks or headers to incoming packets, QoS determines which queue the packets enter, based on priority. This is useful when there are certain types of data you want to give higher priority to, such as voice packets given higher priority than Web data packets.

To utilize your network throughput completely, administrator must define bandwidth control rules carefully to balance the utilization of network bandwidth for all users to access. It is indeed required that an access gateway satisfies the requirements of latency-critical applications, minimum access right guarantee, fair bandwidth usage for same subscribed condition and flexible bandwidth management. AMIT Security Gateway provides a Rule-based QoS to carry out the requirements.

2.8.1 QoS Configuration

This gateway provides lots of flexible rules for you to set QoS policies. Basically, you need to know three parts of information before you create your own policies. First, "who" needs to be managed? Second, "what" kind of service needs to be managed? The last part is "how" you prioritize. Once you have this information, you can continue to learn functions in this section in more detail.

[QoS Rule Configuration](#)

When you want to add a new QoS rule or edit one already existed, the "QoS Rule Configuration" window shows up for you to configure. The parameters in a rule include the applied WAN interfaces, the dedicated host group based on MAC address or IP address, the dedicated kind of service packets, the system resource to be distributed, the corresponding control function for your specified resource, the packet flow direction, the sharing method for the control function, the integrated time schedule rule and the rule activation. Following diagram illustrates how to organize a QoS rule.

4G Vehicle Gateway

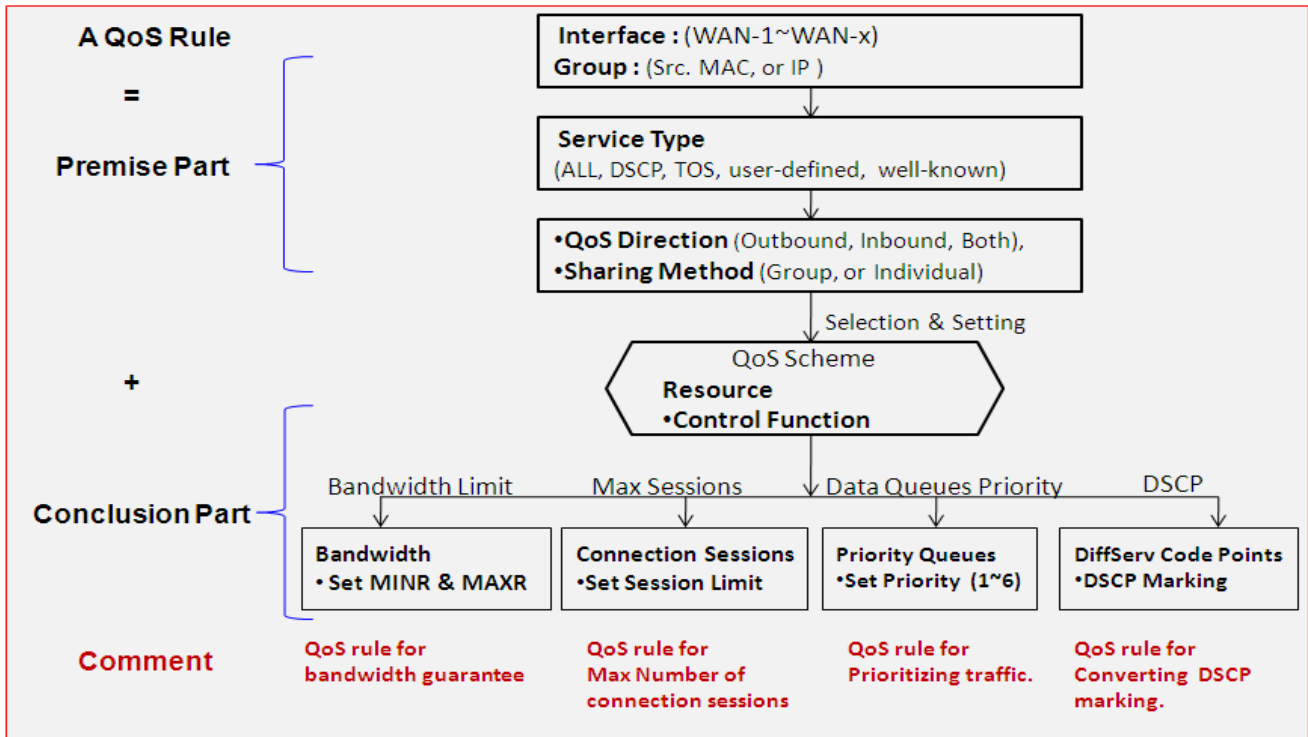

In above diagram, a QoS rule is organized by the premise part and the conclusion part. In the premise part, you must specify the WAN interface, host group, service type in the packets, packet flow direction to be watched and the sharing method of group control or individual control. However, in the conclusion part, you must make sure which kind of system resource to distribute and the control function based on the chosen system resource for the rule.

The Rule-based QoS has following features.

Multiple Group Categories

Specify the group category in a QoS rule for the target objects to be applied on.

Group Category can be based on VLAN ID, MAC Address, IP Address, Host Name or Packet Length.

Differentiated Services

Specify the service type in a QoS rule for the target packets to be applied on.

Differentiated services can be based on 802.1p, DSCP, TOS, VLAN ID, User-defined Services and Well-known Services. Well-known services include FTP(21), SSH(TCP:22), Telnet(23), SMTP(25), DNS(53), TFTP(UDP:69), HTTP(TCP:80), POP3(110), Auth(113), SFTP(TCP:115), SNMP&Traps(UDP:161-162), LDAP(TCP:389), HTTPS(TCP:443), SMTPs(TCP:465), ISAKMP(500), RTSP(TCP:554), POP3s(TCP:995), NetMeeting(1720), L2TP(UDP:1701) and PPTP(TCP:1723).

Available Control Functions

There are 4 resources can be applied in a QoS rule: bandwidth, connection sessions, priority queues and DiffServ Code Point (DSCP). Control function that acts on target objects for specific services of packet flow is based on these resources.

4G Vehicle Gateway

For bandwidth resource, control functions include guaranteeing bandwidth and limiting bandwidth. For priority queue resource, control function is setting priority. For DSCP resource, control function is DSCP marking. The last resource is Connection Sessions; the related control function is limiting connection sessions.

Individual / Group Control

One QoS rule can be applied to individual member or whole group in the target group. This feature depends on model.

Outbound / Inbound Control

One QoS rule can be applied to the outbound or inbound direction of packet flow, even them both. This feature depends on model.

Two QoS rule examples are listed as below.

QoS Rule Example #1 - Connection Sessions

QoS Rule Configuration	
Item	Setting
▶ Interface	WAN - 1
▶ Group	IP 10.0.75.16 Subnet Mask : 255.255.255.240 (/28)
▶ Service	All
▶ Queue Outbound	N/A
▶ Queue Inbound	N/A
▶ Time Schedule	(0) Always
▶ Rule Enable	<input checked="" type="checkbox"/> Enable

When administrator wants to limit maximum connection sessions from some client hosts (IP 10.0.75.16~31) to 20000 to avoid resource unbalanced, he can setup this rule as above configuration.

This rule defines that all client hosts, whose IP address is in the range of 10.0.75.16~31, can access the Internet via "WAN-1" interface under the limitation of the maximum 20000 connection sessions totally at any time

4G Vehicle Gateway

QoS Rule Example #2 – DifferServ Code Points

QoS Rule Configuration	
Item	Setting
▶ Interface	All WANs ▾
▶ Group	IP ▾ 10.0.75.196 Subnet Mask : 255.255.255.252 (/30) ▾
▶ Service	DSCP ▾ ▶ DiffServ CodePoint IP Precedence 4(CS4) ▾
▶ Queue Outbound	N/A
▶ Queue Inbound	N/A
▶ Time Schedule	(0) Always ▾
▶ Rule Enable	<input checked="" type="checkbox"/> Enable

When the administrator of the gateway wants to convert the code point value, "IP Precedence 4(CS4)", in the packets from some client hosts (IP 10.0.75.196~199) to the code value, "AF Class2(High Drop)", he can use the "Rule-based QoS" function to carry out this rule by defining an QoS rule as shown in above configuration. Under such configuration, all packets from WAN interfaces to LAN IP address 10.0.75.196 ~ 10.0.75.199 which have DiffServ code points with "IP Precedence 4(CS4)" value will be modified by "DSCP Marking" control function with "AF Class 2(High Drop)" value at any time.

4G Vehicle Gateway

QoS Configuration Setting

Go to **Basic Network > QoS > Configuration** tab.

In "QoS Configuration" page, there are some configuration windows for QoS function. They are the "Configuration" window, "System Resource Configuration" window, "QoS Rule List" window, and "QoS Rule Configuration" window.

The "Configuration" window can let you activate the Rule-based QoS function. In addition, you can also enable the "Flexible Bandwidth Management" (FBM) feature for better utilization of system bandwidth by FBM algorithm. Second, the "System Configuration" window can let you configure the total bandwidth and session of each WAN. Third, the "QoS Rule List" window lists all your defined QoS rules. At last, the "QoS Rule Configuration" window can let you define one QoS rule.

Enable QoS Function

Item	Setting
▶ QoS Types	Software <input type="checkbox"/> Enable
▶ Flexible Bandwidth Management	<input type="checkbox"/> Enable

Configuration Item	Value Setting	Description
QoS Type	1. Software is selected by default. 2. The box is unchecked by default.	Select the QoS Type from the dropdown list, and then click Enable box to activate the QoS function. The default QoS type is set to Software QoS. For some models, there is another option for Hardware QoS.
Flexible Bandwidth Management	The box is unchecked by default	Click Enable box to activate the Flexible Bandwidth Management function.
Save	N/A	Click the Save button to save the settings.

Check the "Enable" box to activate the "Rule-based QoS" function. Also enable the Flexible Bandwidth Management (FBM) feature when needed. When FBM is enabled, system adjusts the bandwidth distribution dynamically based on current bandwidth usage situation to reach maximum system network performance while transparent to all users. Certainly, the bandwidth subscription profiles of all current users are considered in system's automatic adjusting algorithm.

4G Vehicle Gateway

Setup System Resource

System Resource Configuration	
Item	Setting
▶ Type of System Queue	Bandwidth Queue (1-6) <input type="text" value="6"/> (1~6)
▶ WAN Interface	WAN - 1

WAN Interface Resource	
Item	Setting
▶ Bandwidth of Upstream	<input type="text" value="100"/> Mbps
▶ Bandwidth of Downstream	<input type="text" value="100"/> Mbps
▶ Total Connection Sessions	<input type="text" value="30000"/> (1~100000)

System Resource Configuration		
Item	Value Setting	Description
Type of System Queue	1. A Must filled setting. 2. Bandwidth Queue , and 6 are set by default.	Define the system queues that are available for the QoS settings. The supported type of system queues are Bandwidth Queue and Priority Queues . Value Range: 1 ~ 6.
WAN Interface	WAN-1 is selected by default.	Select the WAN interface and then the following WAN Interface Resource screen will show the related resources for configuration. <ul style="list-style-type: none"> ● Bandwidth of Upstream / Downstream Specify total upload / download bandwidth of the selected WAN. Value Range: For Gigabit Ethernet:1~1024000Kbps, or 1~1000Mbps; For Fast Ethernet: 1~102400Kbps, or 1~100Mbps; For 3G/4G: 1~153600Kbps, or 1~150Mbps. ● Total Connection Sessions Specify total connection sessions of the selected WAN. Value Range: 1 ~ 10000.
Save	N/A	Click the Save button to save the settings.

Each WAN interface should be configured carefully for its upstream bandwidth, downstream bandwidth and maximum number of connection sessions.

4G Vehicle Gateway

Create / Edit QoS Rules

After enabled the QoS function and configured the system resources, you have to further specify some QoS rules for provide better service on the interested traffics. The gateway supports up to a maximum of 128 rule-based QoS rule sets.

QoS Rule List									
Interface	Group	Service	Resource	Control Function	Direction	Sharing Method	Time Schedule	Enable	Actions

When **Add** button is applied, **QoS Rule Configuration** screen will appear.

QoS Rule Configuration	
Item	Setting
▶ Interface	All WANs ▾
▶ Group	Src. MAC Address ▾ <input type="text"/>
▶ Service	All ▾
▶ Resource	Bandwidth ▾
▶ Control Function	Set MINR & MAXR ▾ <input type="text"/> -- <input type="text"/> Mbps ▾
▶ QoS Direction	Outbound ▾
▶ Time Schedule	(0) Always ▾
▶ Rule Enable	<input type="checkbox"/> Enable

QoS Rule Configuration		
Item	Value setting	Description
Interface	<ol style="list-style-type: none"> 1. A Must filled setting. 2. All WANs is selected by default. 	Specify the WAN interface to apply the QoS rule. Select All WANs or a certain WAN-n to filter the packets entering to or leaving from the interface(s).
Group	<ol style="list-style-type: none"> 1. A Must filled setting. 2. Src. MAC Address is selected by default. 	<p>Specify the Group category for the QoS rule. It can be Src. MAC Address, IP, or Host Name.</p> <p>Select Src. MAC Address to prioritize packets based on MAC;</p> <p>Select IP to prioritize packets based on IP address and Subnet Mask;</p> <p>Select Host Name to prioritize packets based on a group of a pre-configured group of host from the dropdown list. If the dropdown list is empty, ensure if any group is pre-configured.</p> <p>Note: The required host groups must be created in advance and corresponding QoS checkbox in the Multiple Bound Services field is checked before the Host</p>

4G Vehicle Gateway

		<p>Group option become available. Refer to Object Definition > Grouping > Host Grouping.</p>
<p>Service</p>	<p>1. A Must filled setting. 2. All is selected by default.</p>	<p>Specify the service type of traffics that have to be applied with the QoS rule. It can be All, DSCP, TOS, User-defined Service, or Well-known Service.</p> <p>Select All for all packets.</p> <p>Select DSCP for DSCP type packets only.</p> <p>Select TOS for TOS type packets only. You have to select a service type (Minimize-Cost, Maximize-Reliability, Maximize-Throughput, or Minimize-Delay) from the dropdown list as well.</p> <p>Select User-defined Service for user-defined packets only. You have to define the port range and protocol as well.</p> <p>Select Well-known Service for specific application packets only. You have to select the required service from the dropdown list as well.</p>
<p>Resource, and Control Function</p>	<p>A Must filled setting</p>	<p>Specify the Resource Type and corresponding Control function for the QoS rule. The available Resource options are Bandwidth, Connection Sessions, Priority Queues, and DiffServ Codepoints.</p> <p>Bandwidth: Select Bandwidth as the resource type for the QoS Rule, and you have to assign the min rate, max rate and rate unit as the bandwidth settings in the Control Function / Set MINR & MAXR field.</p> <p>Connection Sessions: Select Connection Sessions as the resource type for the QoS Rule, and you have to assign supported session number in the Control Function / Set Session Limitation field.</p> <p>Priority Queues: Select Priority Queues as the resource type for the QoS Rule, and you have to specify a priority queue in the Control Function / Set Priority field.</p> <p>DiffServ Code Points: Select DiffServ Code Points as the resource type for the QoS Rule, and you have to select a DSCP marking from the Control Function / DSCP Marking dropdown list.</p>
<p>QoS Direction</p>	<p>1. A Must filled setting. 2. Outbound is selected by default.</p>	<p>Specify the traffic flow direction for the packets to apply the QoS rule. It can be Outbound, Inbound, or Both.</p> <p>Outbound: Select Outbound to prioritize the traffics going to the Internet via the specified interface. Under such situation, the hosts specified in the Group field is a source group.</p> <p>Inbound: Select Inbound to prioritize the traffics coming from the Internet via the specified interface. Under such situation, the hosts specified in the Group field is a destination group.</p> <p>Both: Select both to prioritize the traffics passing through the specified interface, both Inbound and Outbound are considered. Under such situation, the hosts specified in the Group field can be a source or destination group.</p>
<p>Sharing Method</p>	<p>1. A Must filled</p>	<p>Specify the preferred sharing method for how to apply the QoS rule on the</p>

4G Vehicle Gateway

	<p>setting.</p> <p>2. Group Control is selected by default.</p>	<p>selected group. It can be Individual Control or Group Control.</p> <p>Individual Control: If Individual Control is selected, each host in the group will have his own QoS service resource as specified in the rule.</p> <p>Group Control: If Group Control is selected, all the group hosts share the same QoS service resource.</p>
Time Schedule	<p>1. A Must filled setting.</p> <p>2. (0) Always is selected by default.</p>	<p>Apply Time Schedule to this rule; otherwise leave it as (0) Always. (refer to Object Definition > Scheduling > Configuration settings)</p>
Rule Enable	<p>The box is unchecked by default.</p>	<p>Click Enable box to activate this QoS rule.</p>
Save	<p>N/A</p>	<p>Click the Save button to save the settings.</p>

4G Vehicle Gateway

Chapter 3 Object Definition

3.1 Scheduling

Scheduling provides ability of adding/deleting time schedule rules, which can be applied to other functionality.

3.1.1 Scheduling Configuration

Go to **Object Definition > Scheduling > Configuration** tab.

Time Schedule List		
ID	Rule Name	Actions

Button description		
Item	Value setting	Description
Add	N/A	Click the Add button to configure time schedule rule
Delete	N/A	Click the Delete button to delete selected rule(s)

When **Add** button is applied, Time Schedule Configuration and Time Period Definition screens will appear.

Time Schedule Configuration	
Item	Setting
▶ Rule Name	<input type="text"/>
▶ Rule Policy	<input type="text" value="Inactivate"/> the Selected Days and Hours Below.

Time Schedule Configuration		
Item	Value Setting	Description
Rule Name	String: any text	Set rule name
Rule Policy	Default Inactivate	Inactivate/activate the function been applied to in the time period below

4G Vehicle Gateway

Time Period Definition			
ID	Week Day	Start Time (hh:mm)	End Time (hh:mm)
1	-- choose one --		
2	-- choose one --		
3	-- choose one --		
4	-- choose one --		
5	-- choose one --		
6	-- choose one --		
7	-- choose one --		
8	-- choose one --		

Time Period Definition		
Item	Value Setting	Description
Week Day	Select from menu	Select everyday or one of weekday
Start Time	Time format (hh :mm)	Start time in selected weekday
End Time	Time format (hh :mm)	End time in selected weekday
Save	N/A	Click Save to save the settings
Undo	N/A	Click Undo to cancel the settings
Refresh	N/A	Click the Refresh button to refresh the time schedule list.

4G Vehicle Gateway

3.2 User

You can manage user account in this section, including user list, user profile and user group. User List shows out all user accounts, and User Profile can let you add one new account or edit it. User Group offers you to collect several user accounts to one group to own same properties and bound services. Certainly, one individual user account also can be a unique group, like “Administrator” group.

User account database is embedded in the device and accessible by the AAA server, like RADIUS, for user authentication. So, it has the following feature set.

■ Supports Multiple User Levels in User Management

- One user account includes following information: name, password, user level, lease time, idle timeout and the group that it belongs to.
- Support 4 different user levels: Admin, Staff, Guest and Passenger.
- Remaining lease time and idle time are kept for each user account after they have logged in the gateway device successfully.
- Each individual can be one group by itself or join other defined groups to own common properties.
- Support the exporting and importing of user profiles.
- User groups with their owned name can be bound with multiple services, like X-Auth, NAS*, RADIUS, VPN, Accounting & Billing, SNMPv3 and CLI.
- Administrator can define the access policy and bandwidth control in a flexible way for a user object in a rule. The user object can be an individual user or a user group.

3.2.1 User List

User List can show the list of all user accounts and their status of on-line or offline in this window. You can add one new rule by clicking on the “Add” command button. But also you can modify some existed user accounts by clicking corresponding “Edit” command buttons at the end of each account record in the User List. Besides, unnecessary accounts can be removed by checking the “Select” box for those accounts and then clicking on the “Delete” command button at the User List caption. The showing of user status can be refreshed in a period that is defined by you.

Go to **Object Definition > User > User List** tab.

User List displays the user name, user level, membership group name, IP address, on-line status and activity status as following diagram.

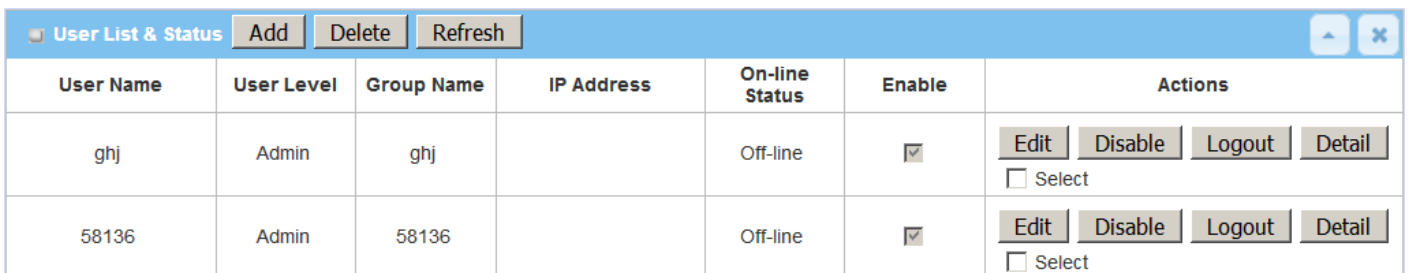

User Name	User Level	Group Name	IP Address	On-line Status	Enable	Actions
ghj	Admin	ghj		Off-line	<input checked="" type="checkbox"/>	<input type="checkbox"/> Select Edit Disable Logout Detail
58136	Admin	58136		Off-line	<input checked="" type="checkbox"/>	<input type="checkbox"/> Select Edit Disable Logout Detail

4G Vehicle Gateway

There are some additional command buttons in the Actions field of User List table.

Edit: Click on the button to edit the user profile.

Disable: Click the button to disable the user account.

Logout: Click the button to logout the user account.

Detail: Click the button to show additional detail information except the ones in User List about the user account, including Last Login Time, Lease Time, Expired Time, Idle Timeout and current Idle Time.

Select: Select the user account to delete.

When the **Add** button is applied, **User Profile Configuration** screen will appear. For the detail about the configuration, please refer to the next section for **User Profile**.

4G Vehicle Gateway

3.2.2 User Profile

User Profile supports the adding of one new user account or the editing of existed user profiles. There are some parameters need to be specified in one user profile. They are User Name, Password, User Level, Lease Time, Idle Timeout, Group to, and the user profile enable.

Go to **Object Definition > User > User Profile** tab.

User Profile Configuration	
Item	Setting
▶ User Name	<input type="text"/>
▶ Password	<input type="password"/>
▶ User Level	Admin <input type="button" value="v"/>
▶ Lease Time	<input type="text"/> (seconds)
▶ Idle Timeout	<input type="text"/> (seconds)
▶ Group to	<input type="text"/>
▶ Profile	<input checked="" type="checkbox"/> Enable

User Profile Configuration		
Item	Value setting	Description
User Name	<ol style="list-style-type: none"> String format can be any text A Must filled setting 	Enter the name of user account.
Password	<ol style="list-style-type: none"> String format can be any text A Must filled setting 	Enter the password of user account.
User Level	<ol style="list-style-type: none"> Admin is selected by default. A Must filled setting 	<p>Select a User Level for the user account. There are 4 available user levels for you to select, including "Admin", "Staff", "Guest" and "Passenger". Admin level of user account can let the user configure the device with fully control ability.</p> <p>Staff level of users can access both the Intranet resources and the Internet resources.</p> <p>Guest level of user account can use limited bandwidth to access Internet, but can't access the Intranet.</p> <p>Passenger level of user account is for mobile users to use the device to access the Internet. He will use fair and average bandwidth utilization with other passengers.</p>
Lease Time	<ol style="list-style-type: none"> Number format can be any integer number. An Optional setting 	Specify the lease time (in seconds) for the user account to login the device. The device will logout the user account if he has logged in for the time longer than the Lease Timeout.

4G Vehicle Gateway

Idle Time	1. Number format can be any integer number. 2. An Optional setting	Specify the idle time (in seconds) for the user account. The device will logout the user account if he is idle for the time longer than the Idle Timeout.
Group to	1. String format can be any text 2. An Optional setting	Enter a group name if you would like to collect the user in a certain user group.
Profile	1. The box is checked by default. 2. A Must filled setting	Check the Enable box to activate the user profile.
Save	N/A	Click the Save button to save the settings
Undo	N/A	Click the Undo button to cancel the settings

4G Vehicle Gateway

3.2.3 User Group

User Group supports the grouping of several user accounts to be one user group with common properties. There are some parameters need to be specified in one user group. They are Group Name, Group Members, Bound Services, QoS&BWM Property, Policy Routing Property and finally, the user group enable.

Go to **Object Definition > User > User Group** tab.

User Group List					
Add Delete Refresh					
ID	Group Name	User Member List	Bound Services	Enable	Actions

When the **Add** button is applied, **User Group Configuration** screen will appear.

User Group Configuration	
Item	Setting
▶ Group Name	<input type="text"/>
▶ Multiple User Members	Choice
▶ Multiple Bound Services	<input type="checkbox"/> X-Auth <input type="checkbox"/> NAS <input type="checkbox"/> RADIUS <input type="checkbox"/> VPN
▶ QoS & BWM Property	Individual Control ▼ Set MINR : <input type="text"/> MAXR : <input type="text"/>
▶ Policy Routing Property	Routing Interface : WAN-1 ▼
▶ Group	<input checked="" type="checkbox"/> Enable

User Profile Configuration		
Item	Value setting	Description
Group Name	1. String format can be any text 2. A Must filled setting	Enter the name of user group. Value Range: at least 1 character, 'A' ~ 'Z', 'a' ~ 'z', and '0' ~ '9' are valid;
Multiple User Members	N/A	Click the Choice button to select multiple user accounts to join the group.
Multiple Bound Services	N/A	Check the available service box(es) to bind with the user group. So, the bound service can use the group object or all user account objects in the group.
QoS & BWM Property	1. A Must filled setting. 2. Individual Control is selected by default.	Specify the preferred sharing method for how to apply a QoS rule on the selected group, and define the guaranteed and limited bandwidth usage for the group It can be Individual Control or Group Control . Individual Control: If Individual Control is selected, each user in the group will have his own QoS service resource as specified in the rule. Group Control: If Group Control is selected, the entire user group shares the same QoS service resource.

4G Vehicle Gateway

Policy Routing Property	<ol style="list-style-type: none">1. A Must filled setting.2. WAN-1 is selected by default.	Specify the routing interface. All packets from the group members will be routed via the specified interface.
Group	<ol style="list-style-type: none">1. The box is checked by default.2. A Must filled setting	Check the Enable box to activate the user group.
Save	N/A	Click the Save button to save the settings
Undo	N/A	Click the Undo button to cancel the settings

4G Vehicle Gateway

3.3 Grouping

The Grouping function allows user to make group for some services.

3.3.1 Host Grouping

Go to **Object Definition > Grouping > Host Grouping** tab.

The Host Grouping function allows user to make host group for some services, such as QoS, Firewall, and Communication Bus. The supported service types could be different for the purchased product.

Host Group List						
ID	Group Name	Group Type	Member List	Bound Services	Enable	Actions

When **Add** button is applied, **Host Group Configuration** screen will appear.

Host Group Configuration	
Item	Setting
▶ Group Name	<input type="text"/>
▶ Group Type	<input type="text" value="IP Address-based"/>
▶ Member to Join	<input type="text"/> <input type="button" value="Join"/>
▶ Member List	
▶ Bound Services	<input type="checkbox"/> Firewall <input type="checkbox"/> QoS
▶ Group	<input type="checkbox"/> Enable

Host Group Configuration		
Item	Value setting	Description
Group Name	1. String format can be any text 2. A Must filled setting	Enter a group name for the rule. It is a name that is easy for you to understand.
Group Type	1. IP Address-based is selected by default. 2. A Must filled setting	Select the group type for the host group. It can be IP Address-based , MAC Address-based , or Host Name-based . When IP Address-based is selected, only IP address can be added in Member to Join . When MAC Address-based is selected, only MAC address can be added in Member to Join .

4G Vehicle Gateway

		<p>When Host Name-based is selected, only host name can be added in Member to Join.</p> <p>Note: The available Group Type can be different for the purchased model.</p>
Member to Join	N/A	<p>Add the members to the group in this field.</p> <p>You can enter the member information as specified in the Member Type above, and press the Join button to add.</p> <p>Only one member can be add at a time, so you have to add the members to the group one by one.</p>
Member List	NA	This field will indicate the hosts (members) contained in the group.
Bound Services	The boxes are unchecked by default	<p>Binding the services that the host group can be applied. If you enable the Firewall, the produced group can be used in firewall service. Same as by enable QoS, or other available service types.</p> <p>Note: The supported service type can be different for the purchased product.</p>
Group	The box is unchecked by default	Check the Enable checkbox to activate the host group rule. So that the group can be bound to selected service(s) for further configuration.
Save	N/A	Click Save to save the settings
Undo	N/A	Click Undo to cancel the settings

4G Vehicle Gateway

3.4 External Server

Go to **Object Definition > External Server > External Server** tab.

The External Server setting allows user to add external server.

Create External Server

External Server List Add Delete						
ID	Server Name	Server Type	Server IP/FQDN	Server Port	Server Enable	Actions

When **Add** button is applied, **External Server Configuration** screen will appear.

External Server Configuration	
Item	Setting
▶ Server Name	<input type="text"/>
▶ Server Type	Email Server <input type="text"/> User Name: <input type="text"/> Password: <input type="text"/>
▶ Server IP/FQDN	<input type="text"/>
▶ Server Port	<input type="text" value="25"/>
▶ Server	<input checked="" type="checkbox"/> Enable
Save Undo	

4G Vehicle Gateway

External Server Configuration		
Item	Value setting	Description
Sever Name	1. String format can be any text 2. A Must filled setting	Enter a server name. Enter a name that is easy for you to understand.
Server Type	A Must filled setting	Specify the Server Type of the external server, and enter the required settings for the accessing the server.
		Email Server (A Must filled setting) : When Email Server is selected, User Name , and Password are also required. User Name (String format: any text) Password (String format: any text)
		RADIUS Server (A Must filled setting) : When RADIUS Server is selected, the following settings are also required. Primary : Shared Key (String format: any text) Authentication Protocol (By default CHAP is selected) Session Timeout (By default 1) The values must be between 1 and 60. Idle Timeout: (By default 1) The values must be between 1 and 15. Secondary : Shared Key (String format: any text) Authentication Protocol (By default CHAP is selected) Session Timeout (By default 1) The values must be between 1 and 60. Idle Timeout: (By default 1) The values must be between 1 and 15.
		Active Directory Server (A Must filled setting) : When Active Directory Server is selected, Domain setting is also required. Domain (String format: any text)
		LDAP Server (A Must filled setting) : When LDAP Server is selected, the following settings are also required. Base DN (String format: any text) Identity (String format: any text) Password (String format: any text)
		UAM Server (A Must filled setting) : When UAM Server is selected, the following settings are also required. Login URL (String format: any text) Shared Secret (String format: any text) NAS/Gateway ID (String format: any text) Location ID (String format: any text) Location Name (String format: any text)

4G Vehicle Gateway

		<p>TACACS+ Server (A Must filled setting) :</p> <p>When TACACS+ Server is selected, the following settings are also required.</p> <p>Shared Key (String format: any text)</p> <p>Session Timeout (String format: any number)</p> <p>The values must be between 1 and 60.</p> <hr/> <p>SCEP Server (A Must filled setting) :</p> <p>When SCEP Server is selected, the following settings are also required.</p> <p>Path (String format: any text, By default cgi-bin is filled)</p> <p>Application (String format: any text, By default pkiclient.exe is filled)</p> <hr/> <p>FTP(SFTP) Server (A Must filled setting) :</p> <p>When FTP(SFTP) Server is selected, the following settings are also required.</p> <p>User Name (String format: any text)</p> <p>Password (String format: any text)</p> <p>Protocol (Select FTP or SFTP)</p> <p>Encryption (Select Plain, Explicit FTPS or Implicit FTPS)</p> <p>Transfer mode (Select Passive or Active)</p>
Server IP/FQDN	A Must filled setting	Specify the IP address or FQDN used for the external server.
Server Port	A Must filled setting	<p>Specify the Port used for the external server. If you selected a certain server type, the default server port number will be set.</p> <p>For Email Server 25 will be set by default;</p> <p>For Syslog Server, port 514 will be set by default;</p> <p>For RADIUS Server, port 1812, 1823 will be set by default;</p> <p>For Active Directory Server, port 389 will be set by default;</p> <p>For LDAP Server, port 389 will be set by default;</p> <p>For UAM Server, port 3990, 4990 will be set by default;</p> <p>For TACACS+ Server, port 49 will be set by default;</p> <p>For SCEP Server, port 80 will be set by default;</p> <p>For FTP(SFTP) Server, port 21 will be set by default;</p> <p>Value Range: 1 ~ 65535.</p>
Account Port	<p>1. A Must filled setting</p> <p>2. 1813 is set by default</p>	<p>Specify the accounting port used if you selected external RADIUS server.</p> <p>Value Range: 1 ~ 65535.</p>
Server	The box is checked by default	Click Enable to activate this External Server.
Save	N/A	Click Save to save the settings
Undo	N/A	Click Undo to cancel the settings
Refresh	N/A	Click the Refresh button to refresh the external server list.

4G Vehicle Gateway

3.5 Certificate

In cryptography, a public key certificate (also known as a digital certificate or identity certificate) is an electronic document used to prove ownership of a public key. The certificate includes information about the key, information about its owner's identity, and the digital signature of an entity that has verified the certificate's contents are genuine. If the signature is valid, and the person examining the certificate trusts the signer, then they know they can use that key to communicate with its owner¹⁰.

In a typical public-key infrastructure (PKI) scheme, the signer is a certificate authority (CA), usually a company such as VeriSign which charges customers to issue certificates for them. In a web of trust scheme, the signer is either the key's owner (a self-signed certificate) or other users ("endorsements") whom the person examining the certificate might know and trust. The device also plays as a CA role.

Certificates are an important component of Transport Layer Security (TLS, sometimes called by its older name SSL), where they prevent an attacker from impersonating a secure website or other server. They are also used in other important applications, such as email encryption and code signing. Here, it can be used in IPsec tunneling for user authentication.

3.5.1 Configuration

The configuration setting allows user to create Root Certificate Authority (CA) certificate and configure to set enable of SCEP. Root CA is the top-most certificate of the tree, the private key of which is used to "sign" other certificates.

Go to **Object Definition > Certificate > Configuration** tab.

Create Root CA



ID	Name	Subject	Issuer	Valid To	Action
----	------	---------	--------	----------	--------

When **Generate** button is applied, **Root CA Certificate Configuration** screen will appear. The required information to be filled for the root CA includes the name, key, subject name and validity.

¹⁰ http://en.wikipedia.org/wiki/Public_key_certificate.

4G Vehicle Gateway

Root CA Certificate Configuration	
Item	Setting
▶ Name	<input type="text"/>
▶ Key	Key Type : <input type="text" value="RSA"/> Key Length : <input type="text" value="512-bits"/> Digest Algorithm : <input type="text" value="MD5"/>
▶ Subject Name	Country(C) : <input type="text"/> State(ST) : <input type="text"/> Location(L) : <input type="text"/> Organization(O) : <input type="text"/> Organization Unit(OU) : <input type="text"/> Common Name(CN) : <input type="text"/> E-mail : <input type="text"/>
▶ Validity Period	<input type="text" value="20-years"/>

Root CA Certificate Configuration		
Item	Value setting	Description
Name	1. String format can be any text 2. A Must filled setting	Enter a Root CA Certificate name. It will be a certificate file name
Key	A Must filled setting	This field is to specify the key attribute of certificate. Key Type to set public-key cryptosystems. It only supports RSA now. Key Length to set s the size measured in bits of the key used in a cryptographic algorithm. Digest Algorithm to set identifier in the signature algorithm identifier of certificates
Subject Name	A Must filled setting	This field is to specify the information of certificate. Country(C) is the two-letter ISO code for the country where your organization is located. State(ST) is the state where your organization is located. Location(L) is the location where your organization is located. Organization(O) is the name of your organization. Organization Unit(OU) is the name of your organization unit. Common Name(CN) is the name of your organization. Email is the email of your organization. It has to be email address style.
Validity Period	A Must filled setting	This field is to specify the validity period of certificate.

4G Vehicle Gateway

Setup SCEP

SCEP Configuration	
Item	Setting
▶ SCEP	<input type="checkbox"/> Enable
▶ Automatically re-enroll aging certificates	<input checked="" type="checkbox"/> Enable

SCEP Configuration		
Item	Value setting	Description
SCEP	The box is unchecked by default	Check the Enable box to activate SCEP function.
Automatically re-enroll aging certificates	The box is unchecked by default	When SCEP is activated, check the Enable box to activate this function. It will be automatically check which certificate is aging. If certificate is aging, it will activate SCEP function to re-enroll automatically.
Save	N/A	Click Save to save the settings
Undo	N/A	Click Undo to cancel the settings

4G Vehicle Gateway

3.5.2 My Certificate

My Certificate includes a Local Certificate List. Local Certificate List shows all generated certificates by the root CA for the gateway. And it also stores the generated Certificate Signing Requests (CSR) which will be signed by other external CAs. The signed certificates can be imported as the local ones of the gateway.

Self-signed Certificate Usage Scenario

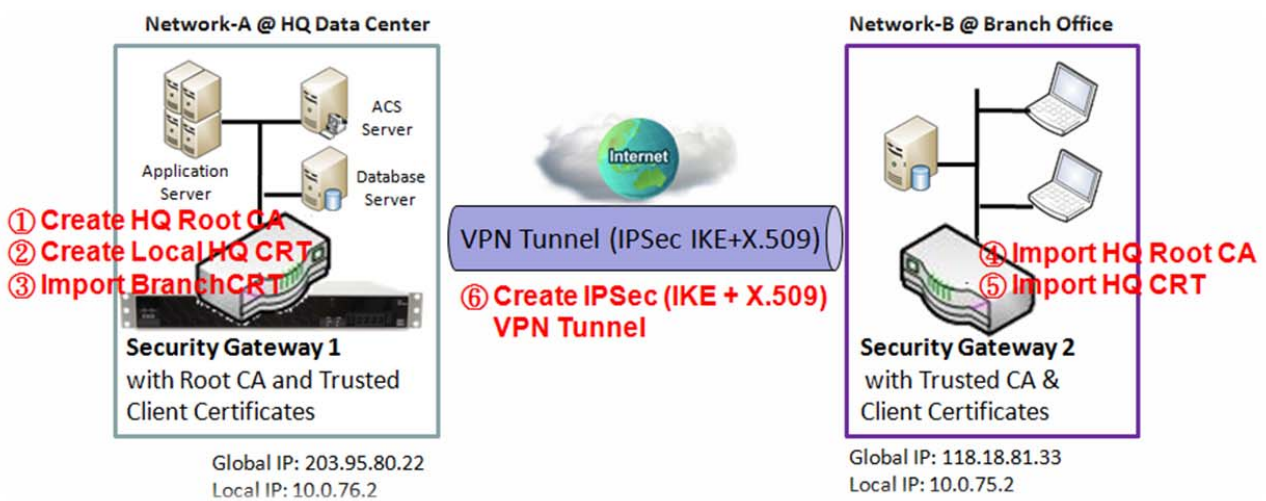

Scenario Application Timing

When the enterprise gateway owns the root CA and VPN tunneling function, it can generate its own local certificates by being signed by itself or import any local certificates that are signed by other external CAs. Also import the trusted certificates for other CAs and Clients. In addition, since it has the root CA, it also can sign Certificate Signing Requests (CSR) to form corresponding certificates for others. These certificates can be used for two remote peers to make sure their identity during establishing a VPN tunnel.

Scenario Description

Gateway 1 generates the root CA and a local certificate (HQCRT) signed by itself. Import a trusted certificate (BranchCRT) –a BranchCSR certificate of Gateway 2 signed by root CA of Gateway 1.

Gateway 2 creates a CSR (BranchCSR) to let the root CA of the Gateway 1 sign it to be the BranchCRT certificate. Import the certificate into the Gateway 2 as a local certificate. In addition, also import the certificates of the root CA of the Gateway 1 into the Gateway 2 as the trusted ones. (Please also refer to following two sub-sections)

Establish an IPSec VPN tunnel with IKE and X.509 protocols by starting from either peer, so that all

4G Vehicle Gateway

client hosts in these both subnets can communicate with each other.

Parameter Setup Example

For Network-A at HQ

Following tables list the parameter configuration as an example for the "My Certificate" function used in the user authentication of IPSec VPN tunnel establishing, as shown in above diagram. The configuration example must be combined with the ones in following two sections to complete the whole user scenario.

Use default value for those parameters that are not mentioned in the tables.

Configuration Path	[My Certificate]-[Root CA Certificate Configuration]
Name	HQRootCA
Key	Key Type: RSA Key Length: 1024-bits
Subject Name	Country(C): TW State(ST): Taiwan Location(L): Tainan Organization(O): AMITHQ Organization Unit(OU): HQRD Common Name(CN): HQRootCA E-mail: hqrootca@amit.com.tw

Configuration Path	[My Certificate]-[Local Certificate Configuration]
Name	HQCRT Self-signed: <input checked="" type="checkbox"/>
Key	Key Type: RSA Key Length: 1024-bits
Subject Name	Country(C): TW State(ST): Taiwan Location(L): Tainan Organization(O): AMITHQ Organization Unit(OU): HQRD Common Name(CN): HQCRT E-mail: hqcert@amit.com.tw

Configuration Path	[IPSec]-[Configuration]
IPSec	<input checked="" type="checkbox"/> Enable

Configuration Path	[IPSec]-[Tunnel Configuration]
Tunnel	<input checked="" type="checkbox"/> Enable
Tunnel Name	s2s-101
Interface	WAN 1
Tunnel Scenario	Site to Site
Operation Mode	Always on

Configuration Path	[IPSec]-[Local & Remote Configuration]
Local Subnet	10.0.76.0
Local Netmask	255.255.255.0
Full Tunnel	Disable
Remote Subnet	10.0.75.0
Remote Netmask	255.255.255.0
Remote Gateway	118.18.81.33

4G Vehicle Gateway

Configuration Path	[IPSec]-[Authentication]
Key Management	<i>IKE+X.509</i> Local Certificate: <i>HQCRT</i> Remote Certificate: <i>BranchCRT</i>
Local ID	<i>User Name Network-A</i>
Remote ID	<i>User Name Network-B</i>

Configuration Path	[IPSec]-[IKE Phase]
Negotiation Mode	<i>Main Mode</i>
X-Auth	<i>None</i>

For Network-B at Branch Office

Following tables list the parameter configuration as an example for the "My Certificate" function used in the user authentication of IPSec VPN tunnel establishing, as shown in above diagram. The configuration example must be combined with the ones in following two sections to complete the whole user scenario.

Use default value for those parameters that are not mentioned in the tables.

Configuration Path	[My Certificate]-[Local Certificate Configuration]
Name	<i>BranchCRT</i> Self-signed: <input type="checkbox"/>
Key	Key Type: <i>RSA</i> Key Length: <i>1024-bits</i>
Subject Name	Country(C): <i>TW</i> State(ST): <i>Taiwan</i> Location(L): <i>Tainan</i> Organization(O): <i>AMITBranch</i> Organization Unit(OU): <i>BranchRD</i> Common Name(CN): <i>BranchCRT</i> E-mail: <i>branchcrt@amit.com.tw</i>

Configuration Path	[IPSec]-[Configuration]
IPSec	■ <i>Enable</i>

Configuration Path	[IPSec]-[Tunnel Configuration]
Tunnel	■ <i>Enable</i>
Tunnel Name	<i>s2s-102</i>
Interface	<i>WAN 1</i>
Tunnel Scenario	<i>Site to Site</i>
Operation Mode	<i>Always on</i>

Configuration Path	[IPSec]-[Local & Remote Configuration]
Local Subnet	<i>10.0.75.0</i>
Local Netmask	<i>255.255.255.0</i>
Full Tunnel	<i>Disable</i>
Remote Subnet	<i>10.0.76.0</i>

4G Vehicle Gateway

Remote Netmask	<i>255.255.255.0</i>
Remote Gateway	<i>203.95.80.22</i>

Configuration Path	[IPSec]-[Authentication]
Key Management	<i>IKE+X.509</i> Local Certificate: <i>BranchCRT</i> Remote Certificate: <i>HQCRT</i>
Local ID	<i>User Name Network-B</i>
Remote ID	<i>User Name Network-A</i>

Configuration Path	[IPSec]-[IKE Phase]
Negotiation Mode	<i>Main Mode</i>
X-Auth	<i>None</i>

Scenario Operation Procedure

In above diagram, "Gateway 1" is the gateway of Network-A in headquarters and the subnet of its Intranet is 10.0.76.0/24. It has the IP address of 10.0.76.2 for LAN interface and 203.95.80.22 for WAN-1 interface. "Gateway 2" is the gateway of Network-B in branch office and the subnet of its Intranet is 10.0.75.0/24. It has the IP address of 10.0.75.2 for LAN interface and 118.18.81.33 for WAN-1 interface. They both serve as the NAT security gateways.

Gateway 1 generates the root CA and a local certificate (HQCRT) that is signed by itself. Import the certificates of the root CA and HQCRT into the "Trusted CA Certificate List" and "Trusted Client Certificate List" of Gateway 2.

Gateway 2 generates a Certificate Signing Request (BranchCSR) for its own certificate (BranchCRT) (Please generate one not self-signed certificate in the Gateway 2, and click on the "View" button for that CSR. Just downloads it). Take the CSR to be signed by the root CA of Gateway 1 and obtain the BranchCRT certificate (you need rename it). Import the certificate into the "Trusted Client Certificate List" of the Gateway 1 and the "Local Certificate List" of Gateway 2.

Gateway 2 can establish an IPSec VPN tunnel with "Site to Site" scenario and IKE and X.509 protocols to Gateway 1.

Finally, the client hosts in two subnets of 10.0.75.0/24 and 10.0.76.0/24 can communicate with each other.

4G Vehicle Gateway

My Certificate Setting

Go to **Object Definition > Certificate > My Certificate** tab.

The My Certificate setting allows user to create local certificates. In "My Certificate" page, there are two configuration windows for the "My Certificate" function. The "Local Certificate List" window shows the stored certificates or CSRs for representing the gateway. The "Local Certificate Configuration" window can let you fill required information necessary for corresponding certificate to be generated by itself, or corresponding CSR to be signed by other CAs.

Create Local Certificate

ID	Name	Subject	Issuer	Valid To	Actions
Local Certificate List <input type="button" value="Add"/> <input type="button" value="Import"/> <input type="button" value="Delete"/>					

When **Add** button is applied, **Local Certificate Configuration** screen will appear. The required information to be filled for the certificate or CSR includes the name, key and subject name. It is a certificate if the "Self-signed" box is checked; otherwise, it is a CSR.

Item	Setting
Name	<input type="text"/> Self-signed : <input type="checkbox"/>
Key	Key Type : <input type="text" value="RSA"/> Key Length : <input type="text" value="1024-bits"/> Digest Algorithm : <input type="text" value="SHA-1"/>
Subject Name	Country(C) : <input type="text"/> State(ST) : <input type="text"/> Location(L) : <input type="text"/> Organization(O) : <input type="text"/> Organization Unit(OU) : <input type="text"/> Common Name(CN) : <input type="text"/> E-mail : <input type="text"/>
Extra Attributes	Challenge Password: <input type="text"/> Unstructured Name: <input type="text"/>
SCEP Enrollment	Enable: <input type="checkbox"/> SCEP Server: <input type="text" value="--- Option ---"/> <input type="button" value="Add Object"/> CA Certificate: <input type="text" value="amit-IDG761AM-JH.crt"/> CA Encryption Certificate: <input type="text" value="--- Option ---"/> (Optional) CA Identifier: <input type="text"/> (Optional)

4G Vehicle Gateway

Local Certificate Configuration		
Item	Value setting	Description
Name	1. String format can be any text 2. A Must filled setting	Enter a certificate name. It will be a certificate file name If Self-signed is checked, it will be signed by root CA. If Self-signed is not checked, it will generate a certificate signing request (CSR).
Key	A Must filled setting	This field is to specify the key attributes of certificate. Key Type to set public-key cryptosystems. Currently, only RSA is supported. Key Length to set the length in bits of the key used in a cryptographic algorithm. It can be 512/768/1024/1536/2048. Digest Algorithm to set identifier in the signature algorithm identifier of certificates. It can be MD5/SHA-1.
Subject Name	A Must filled setting	This field is to specify the information of certificate. Country(C) is the two-letter ISO code for the country where your organization is located. State(ST) is the state where your organization is located. Location(L) is the location where your organization is located. Organization(O) is the name of your organization. Organization Unit(OU) is the name of your organization unit. Common Name(CN) is the name of your organization. Email is the email of your organization. It has to be email address setting only.
Extra Attributes	A Must filled setting	This field is to specify the extra information for generating a certificate. Challenge Password for the password you can use to request certificate revocation in the future. Unstructured Name for additional information.
SCEP Enrollment	A Must filled setting	This field is to specify the information of SCEP. If user wants to generate a certificate signing request (CSR) and then signed by SCEP server online, user can check the Enable box. Select a SCEP Server to identify the SCEP server for use. The server detailed information could be specified in External Servers. Refer to Object Definition > External Server > External Server . You may click Add Object button to generate, and the settings are the same as those defined in Section 3.4 External Server . Select a CA Certificate to identify which certificate could be accepted by SCEP server for authentication. It could be generated in Trusted Certificates. Select an optional CA Encryption Certificate , if it is required, to identify which certificate could be accepted by SCEP server for encryption data information. It could be generated in Trusted Certificates. Fill in optional CA Identifier to identify which CA could be used for signing certificates.
Save	N/A	Click the Save button to save the configuration.
Back	N/A	When the Back button is clicked, the screen will return to previous page.

4G Vehicle Gateway

When **Import** button is applied, an Import screen will appear. You can import a certificate from an existed certificate file, or directly paste a PEM encoded string as the certificate.

The screenshot shows a user interface for importing certificates. It features two main sections: 'Import' and 'PEM Encoded'. Each section has a radio button, an 'Apply' button, and a 'Cancel' button. The 'Import' section includes a file selection button labeled '瀏覽...' and the text '未選擇檔案。' (No file selected). The 'PEM Encoded' section has a large empty text area for pasting the certificate string.

Import Item	Value setting	Description
Import	A Must filled setting	Select a certificate file from user's computer, and click the Apply button to import the specified certificate file to the gateway.
PEM Encoded	1. String format can be any text 2. A Must filled setting	This is an alternative approach to import a certificate. You can directly fill in (Copy and Paste) the PEM encoded certificate string, and click the Apply button to import the specified certificate to the gateway.
Apply	N/A	Click the Apply button to import the certificate.
Cancel	N/A	Click the Cancel button to discard the import operation and the screen will return to the My Certificates page.

4G Vehicle Gateway

3.5.3 Trusted Certificate

Trusted Certificate includes Trusted CA Certificate List, Trusted Client Certificate List, and Trusted Client Key List. The Trusted CA Certificate List places the certificates of external trusted CAs. The Trusted Client Certificate List places the others' certificates what you trust. And the Trusted Client Key List places the others' keys what you trusted.

Self-signed Certificate Usage Scenario

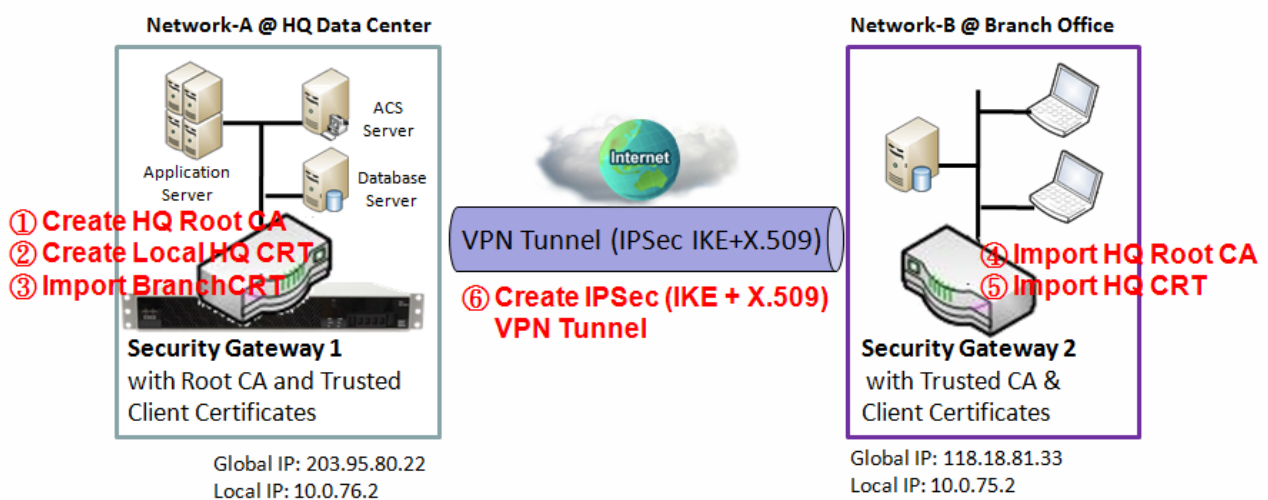

Scenario Application Timing (same as the one described in "My Certificate" section)

When the enterprise gateway owns the root CA and VPN tunneling function, it can generate its own local certificates by being signed by itself. Also imports the trusted certificates for other CAs and Clients. These certificates can be used for two remote peers to make sure their identity during establishing a VPN tunnel.

Scenario Description (same as the one described in "My Certificate" section)

Gateway 1 generates the root CA and a local certificate (HQCRT) signed by itself. Import a trusted certificate (BranchCRT) –a BranchCSR certificate of Gateway 2 signed by root CA of Gateway 1.

Gateway 2 creates a CSR (BranchCSR) to let the root CA of the Gateway 1 sign it to be the BranchCRT certificate. Import the certificate into the Gateway 2 as a local certificate. In addition, also imports the certificates of the root CA of Gateway 1 into the Gateway 2 as the trusted ones. (Please also refer to "My Certificate" and "Issue Certificate" sections).

Establish an IPSec VPN tunnel with IKE and X.509 protocols by starting from either peer, so that all client hosts in these both subnets can communicate with each other.

Parameter Setup Example (same as the one described in "My Certificate" section)

4G Vehicle Gateway

For Network-A at HQ

Following tables list the parameter configuration as an example for the "Trusted Certificate" function used in the user authentication of IPSec VPN tunnel establishing, as shown in above diagram. The configuration example must be combined with the ones in "My Certificate" and "Issue Certificate" sections to complete the setup for the whole user scenario.

Configuration Path	[Trusted Certificate]-[Trusted Client Certificate List]
Command Button	<i>Import</i>

Configuration Path	[Trusted Certificate]-[Trusted Client Certificate Import from a File]
File	<i>BranchCRT.crt</i>

For Network-B at Branch Office

Following tables list the parameter configuration as an example for the "Trusted Certificate" function used in the user authentication of IPSec VPN tunnel establishing, as shown in above diagram. The configuration example must be combined with the ones in "My Certificate" and "Issued Certificate" sections to complete the setup for the whole user scenario.

Configuration Path	[Trusted Certificate]-[Trusted CA Certificate List]
Command Button	<i>Import</i>

Configuration Path	[Trusted Certificate]-[Trusted CA Certificate Import from a File]
File	<i>HQRootCA.crt</i>

Configuration Path	[Trusted Certificate]-[Trusted Client Certificate List]
Command Button	<i>Import</i>

Configuration Path	[Trusted Certificate]-[Trusted Client Certificate Import from a File]
File	<i>HQCRT.crt</i>

Scenario Operation Procedure (same as the one described in "My Certificate" section)

In above diagram, the "Gateway 1" is the gateway of Network-A in headquarters and the subnet of its Intranet is 10.0.76.0/24. It has the IP address of 10.0.76.2 for LAN interface and 203.95.80.22 for WAN-1 interface. The "Gateway 2" is the gateway of Network-B in branch office and the subnet of its Intranet is 10.0.75.0/24. It has the IP address of 10.0.75.2 for LAN interface and 118.18.81.33 for WAN-1 interface. They both serve as the NAT security gateways.

In Gateway 2 import the certificates of the root CA and HQCRT that were generated and signed by Gateway 1 into the "Trusted CA Certificate List" and "Trusted Client Certificate List" of Gateway 2.

4G Vehicle Gateway

Import the obtained BranchCRT certificate (the derived BranchCSR certificate after Gateway 1's root CA signature) into the "Trusted Client Certificate List" of the Gateway 1 and the "Local Certificate List" of the Gateway 2. For more details, refer to the Network-B operation procedure in "My Certificate" section of this manual.

Gateway 2 can establish an IPSec VPN tunnel with "Site to Site" scenario and IKE and X.509 protocols to Gateway 1.

Finally, the client hosts in two subnets of 10.0.75.0/24 and 10.0.76.0/24 can communicate with each other.

4G Vehicle Gateway

Trusted Certificate Setting

Go to **Object Definition > Certificate > Trusted Certificate** tab.

The Trusted Certificate setting allows user to import trusted certificates and keys.

Import Trusted CA Certificate



ID	Name	Subject	Issuer	Valid To	Actions
----	------	---------	--------	----------	---------

When **Import** button is applied, a **Trusted CA import** screen will appear. You can import a Trusted CA certificate from an existed certificate file, or directly paste a PEM encoded string as the certificate.

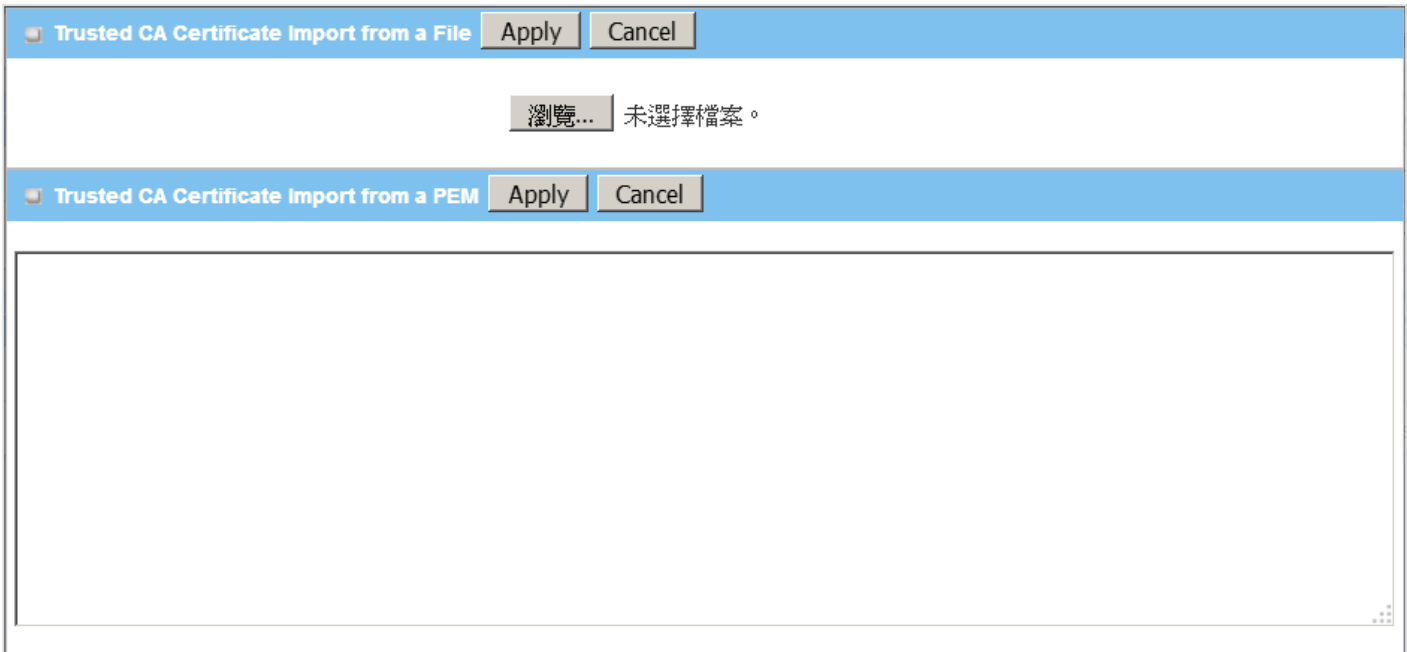

Trusted CA Certificate List		
Item	Value setting	Description
Import from a File	A Must filled setting	Select a CA certificate file from user's computer, and click the Apply button to import the specified CA certificate file to the gateway.
Import from a PEM	1. String format can be any text 2. A Must filled setting	This is an alternative approach to import a CA certificate. You can directly fill in (Copy and Paste) the PEM encoded CA certificate string, and click the Apply button to import the specified CA certificate to the gateway.
Apply	N/A	Click the Apply button to import the certificate.
Cancel	N/A	Click the Cancel button to discard the import operation and the screen will return to the Trusted Certificates page.

4G Vehicle Gateway

Instead of importing a Trusted CA certificate with mentioned approaches, you can also get the CA certificate from the SECP server.

If **SCEP** is enabled (Refer to **Object Definition > Certificate > Configuration**), you can click **Get CA** button, a Get CA Configuration screen will appear.

Get CA Configuration	
Item	Setting
▶ SCEP Server	<input type="text" value="--- Option ---"/> <input type="button" value="Add Object"/>
▶ CA Identifier	<input type="text"/> (Optional)

Get CA Configuration		
Item	Value setting	Description
SCEP Server	A Must filled setting	Select a SCEP Server to identify the SCEP server for use. The server detailed information could be specified in External Servers. Refer to Object Definition > External Server > External Server . You may click Add Object button to generate.
CA Identifier	1. String format can be any text	Fill in optional CA Identifier to identify which CA could be used for signing certificates.
Save	N/A	Click Save to save the settings.
Close	N/A	Click the Close button to return to the Trusted Certificates page.

Import Trusted Client Certificate

Trusted Client Certificate List					
ID	Name	Subject	Issuer	Vaild To	Actions
<input type="button" value="Import"/> <input type="button" value="Delete"/>					

When **Import** button is applied, a **Trusted Client Certificate Import** screen will appear. You can import a Trusted Client Certificate from an existed certificate file, or directly paste a PEM encoded string as the certificate.

4G Vehicle Gateway

Trusted Client Certificate Import from a File
Apply
Cancel

瀏覽... 未選擇檔案。

Trusted Client Certificate Import from a PEM
Apply
Cancel

Trusted Client Certificate List		
Item	Value setting	Description
Import from a File	A Must filled setting	Select a certificate file from user's computer, and click the Apply button to import the specified certificate file to the gateway.
Import from a PEM	1. String format can be any text 2. A Must filled setting	This is an alternative approach to import a certificate. You can directly fill in (Copy and Paste) the PEM encoded certificate string, and click the Apply button to import the specified certificate to the gateway.
Apply	N/A	Click the Apply button to import certificate.
Cancel	N/A	Click the Cancel button to discard the import operation and the screen will return to the Trusted Certificates page.

Import Trusted Client Key

Trusted Client Key List
Import
Delete
↑ ×

ID	Name	Actions

When **Import** button is applied, a **Trusted Client Key Import** screen will appear. You can import a Trusted Client Key from an existed file, or directly paste a PEM encoded string as the key.

4G Vehicle Gateway

Trusted Client Key Import from a File
Apply
Cancel

瀏覽... 未選擇檔案。

Trusted Client Key Import from a PEM
Apply
Cancel

Trusted Client Key List		
Item	Value setting	Description
Import from a File	A Must filled setting	Select a certificate key file from user's computer, and click the Apply button to import the specified key file to the gateway.
Import from a PEM	1. String format can be any text 2. A Must filled setting	This is an alternative approach to import a certificate key. You can directly fill in (Copy and Paste) the PEM encoded certificate key string, and click the Apply button to import the specified certificate key to the gateway.
Apply	N/A	Click the Apply button to import the certificate key.
Cancel	N/A	Click the Cancel button to discard the import operation and the screen will return to the Trusted Certificates page.

4G Vehicle Gateway

3.5.4 Issue Certificate

When you have a Certificate Signing Request (CSR) that needs to be certificated by the root CA of the device, you can issue the request here and let Root CA sign it. There are two approaches to issue a certificate. One is from a CSR file importing from the managing PC and another is copy-paste the CSR codes in gateway's web-based utility, and then click on the "Sign" button.

If the gateway signs a CSR successfully, the "Signed Certificate View" window will show the resulted certificate contents. In addition, a "Download" button is available for you to download the certificate to a file in the managing PC.

Self-signed Certificate Usage Scenario

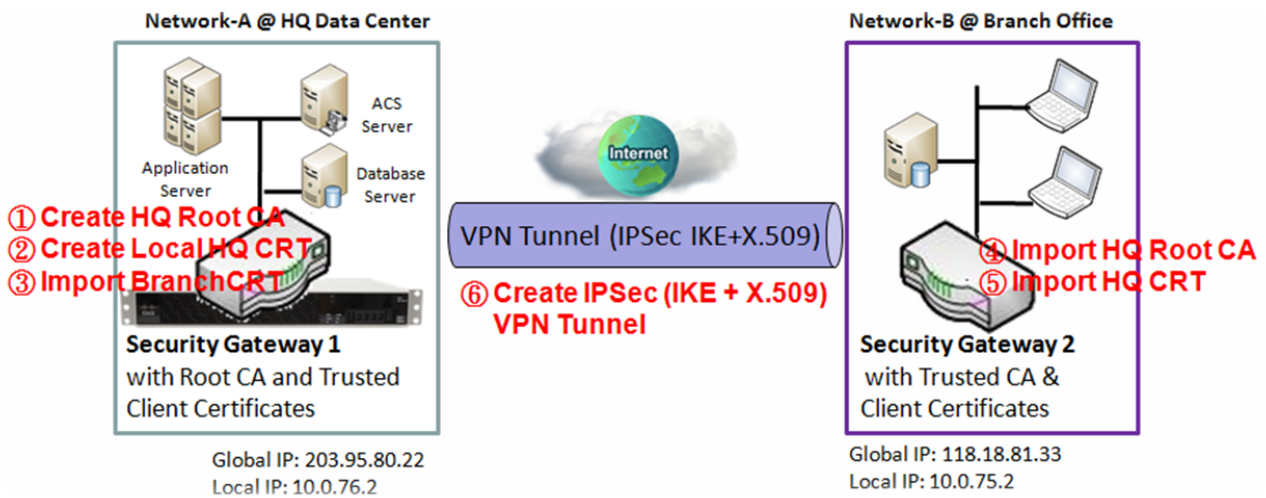

Scenario Application Timing (same as the one described in "My Certificate" section)

When the enterprise gateway owns the root CA and VPN tunneling function, it can generate its own local certificates by being signed by itself. Also imports the trusted certificates for other CAs and Clients. These certificates can be used for two remote peers to make sure their identity during establishing a VPN tunnel.

Scenario Description (same as the one described in "My Certificate" section)

Gateway 1 generates the root CA and a local certificate (HQCRT) signed by itself. Also imports a trusted certificate (BranchCRT) –a BranchCSR certificate of Gateway 2 signed by root CA of Gateway 1.

Gateway 2 creates a CSR (BranchCSR) to let the root CA of the Gateway 1 sign it to be the BranchCRT certificate. Import the certificate into the Gateway 2 as a local certificate. In addition, also imports the certificates of the root CA of the Gateway 1 into the Gateway 2 as the trusted ones. (Please also refer

4G Vehicle Gateway

to "My Certificate" and "Trusted Certificate" sections).

Establish an IPSec VPN tunnel with IKE and X.509 protocols by starting from either peer, so that all client hosts in these both subnets can communicate with each other.

Parameter Setup Example (same as the one described in "My Certificate" section)

For Network-A at HQ

Following tables list the parameter configuration as an example for the "Issue Certificate" function used in the user authentication of IPSec VPN tunnel establishing, as shown in above diagram. The configuration example must be combined with the ones in "My Certificate" and "Trusted Certificate" sections to complete the setup for whole user scenario.

Configuration Path	[Issue Certificate]-[Certificate Signing Request Import from a File]
Browse	<i>C:/BranchCSR</i>
Command Button	<i>Sign</i>

Configuration Path	[Issue Certificate]-[Signed Certificate View]
Command Button	<i>Download</i> (default name is "issued.crt")

Scenario Operation Procedure (same as the one described in "My Certificate" section)

In above diagram, the "Gateway 1" is the gateway of Network-A in headquarters and the subnet of its Intranet is 10.0.76.0/24. It has the IP address of 10.0.76.2 for LAN interface and 203.95.80.22 for WAN-1 interface. The "Gateway 2" is the gateway of Network-B in branch office and the subnet of its Intranet is 10.0.75.0/24. It has the IP address of 10.0.75.2 for LAN interface and 118.18.81.33 for WAN-1 interface. They both serve as the NAT security gateways.

Gateway 1 generates the root CA and a local certificate (HQCRT) that is signed by itself. Import the certificates of the root CA and HQCRT into the "Trusted CA Certificate List" and "Trusted Client Certificate List" of Gateway 2.

Gateway 2 generates a Certificate Signing Request (BranchCSR) for its own certificate BranchCRT to be signed by root CA (Please generate one not self-signed certificate in the Gateway 2, and click on the "View" button for that CSR. Just downloads it). Take the CSR to be signed by the root CA of the Gateway 1 and obtain the BranchCRT certificate (you need rename it). Import the certificate into the "Trusted Client Certificate List" of the Gateway 1 and the "Local Certificate List" of the Gateway 2.

Gateway 2 can establish an IPSec VPN tunnel with "Site to Site" scenario and IKE and X.509 protocols to Gateway 1.

Finally, the client hosts in two subnets of 10.0.75.0/24 and 10.0.76.0/24 can communicate with each other.

4G Vehicle Gateway

Issue Certificate Setting

Go to **Object Definition > Certificate > Issue Certificate** tab.

The Issue Certificate setting allows user to import Certificate Signing Request (CSR) to be signed by root CA.

Import and Issue Certificate

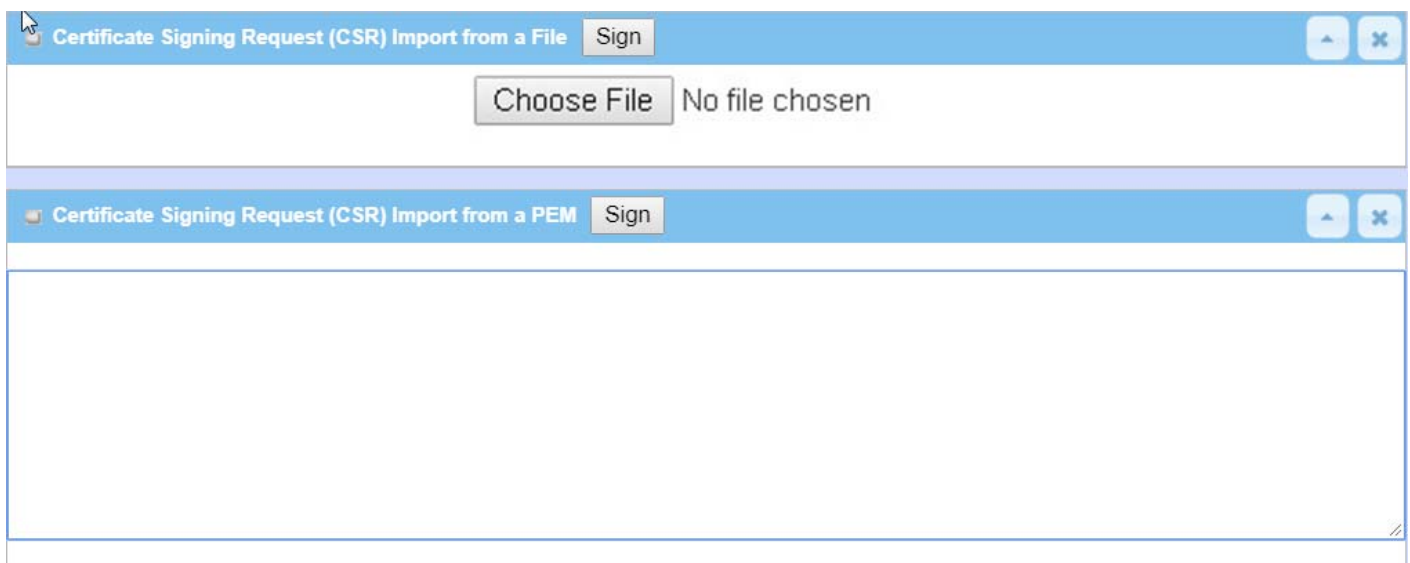

Certificate Signing Request (CSR) Import from a File Item	Value setting	Description
Certificate Signing Request (CSR) Import from a File	A Must filled setting	Select a certificate signing request file you're your computer for importing to the gateway.
Certificate Signing Request (CSR) Import from a PEM	1. String format can be any text 2. A Must filled setting	Enter (copy-paste) the certificate signing request PEM encoded certificate to the gateway.
Sign	N/A	When root CA is exist, click the Sign button sign and issue the imported certificate by root CA.

4G Vehicle Gateway

Chapter 4 Field Communication

4.1 Bus & Protocol

The gateway may equip a serial port for various serial communication use through connecting the RS-232 or RS-485 serial device to an IP-based Ethernet LAN. These communication protocols make user access serial devices anywhere over a local LAN or the Internet easily.

4.1.1 Port Configuration

Before using the supported field communication function, like Virtual COM, you need to configure the physical communication port first.

The port configuration screen allows user to configure the operation mode and physical layer settings for each serial interface, and also can quick switch from one communication protocol to another for the serial port. The number of ports and type of the supported protocols could be different for the purchased gateway model.

Port Configuration Setting

Go to **Field Communication > Bus & Protocol > Port Configuration** tab.

In "Port Configuration" page, there is only one configuration window for the serial port settings. The "Configuration" window can let you specify serial port parameters including the operation mode being "Virtual COM" or disabled, the interface, the baud rate, the data bit length, the stop bit length, the flow control being "RTS/CTS", "DTS/DSR" or "None", and the parity.

Serial Port	Operation Mode	Interface	Baud Rate	Data Bits	Stop Bits	Flow Control	Parity	Action
SPort-0	Disable ▼	RS-232 ▼	9600 ▼	8 ▼	1 ▼	None ▼	None ▼	Edit

Port Configuration Window		
Item	Value setting	Description
Serial Port	N/A	It displays the serial port ID of the serial port. The number of serial ports varies from the purchased model.
Operation Mode	Disable is set by default	It displays the current selected operation mode for the serial interface.
Interface	RS-232 is set by default	Select the physical interface type for connecting to the access device(s) with the same interface specification.

4G Vehicle Gateway

		Depending on the purchase model, the supported interface type could be RS-232 or RS-485.
Baud Rate	19200 is set by default	Select the appropriate baud rate for serial device communication. RS-232: 1200 / 2400 / 4800 / 9600 / 19200 / 38400 / 57600 / 115200 RS-485 can use higher baud rate for 230400 and 460800. It depends on the cable length and the installed environment. The longer cable, the lower baud rate for it.
Data Bits	8 is set by default	Select 8 or 7 for data bits.
Stop Bits	1 is set by default	Select 1 or 2 for stop bits.
Flow Control	None is set by default	Select None / RTS, CTS / DTS, DSR for Flow Control in RS-232 mode. The supporting of Flow Control depends on the purchased model.
Parity	None is set by default	Select None / Even / Odd for Parity bit.
Action	N/A	Click Edit button to change the operation mode, or modify the parameters mentioned above for the serial interface communication.
Save	N/A	Click Save button to save the settings.
Undo	N/A	Click Undo button to cancel the settings.

4G Vehicle Gateway

4.1.2 Virtual COM

Create a virtual COM port on user's PC/Host to provide access to serial device connected to the serial port on gateway. Therefore, users can access, control, and manage the connected serial device through Internet (fixed line, or cellular network) anywhere. This application is also known as Ethernet pass-through communication.

Operation Mode Definition for each Serial Port									
Serial Port	Operation Mode	Listen Port	Trust Type	Max Connection	Connection Control	Connection Idle Timeout	Alive Check Timeout	Enable	Action
SPort-0	Disable	N/A	N/A	N/A	N/A	N/A	N/A	<input type="checkbox"/>	Edit

Virtual COM setting screen enables user to connect a Virtual COM port based device to the Internet. It allows user to access serial data remotely. There are Disable, TCP Client, TCP Server, UDP, and RFC2217 modes for remote accessing the connected serial device. These operation modes are illustrated as below.

TCP Client Mode

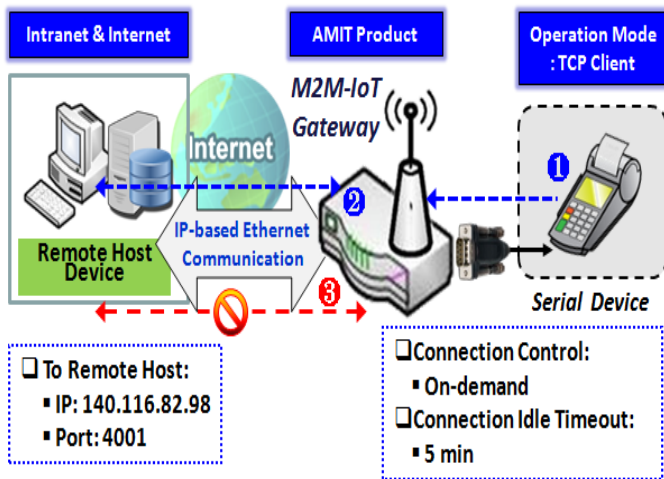

- 1 Gateway get Data received from Serial Device.
- 2 Establish a TCP Connection and Transmit Data to Remote Host.
- 3 Terminate this TCP Connection once Idle Timeout reached 5 mins.

When the administrator expects the gateway to actively establish a TCP connection to a pre-defined host computer when serial data arrives, the operation mode for the "Virtual COM" function is required to be "TCP Client" and when the connection control of virtual COM is "On-demand", once the gateway receives data from the connected serial device, it will establish a TCP connection to transfer the received serial data to the remote host. Besides, after the data has been transferred, the gateway automatically disconnects the established TCP session from the host computer by using the TCP alive check timeout or idle timeout settings.

4G Vehicle Gateway

TCP Server Mode

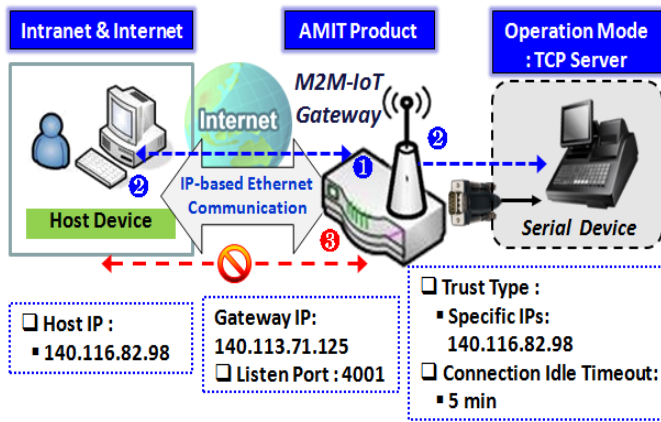

- ① Gateway remain Listening and Host will Establish a TCP Connection with it.
- ② Host Send Data then Gateway Transmit it to the Serial Device.
- ③ Terminate this TCP Connection once Idle Timeout reached 5 mins.

When the administrator expects the gateway to wait passively for the serial data requests from the Host Device (usually we use a computer to play as a Host), and the Host will establish a TCP connection to get data from the serial device, the operation mode for the "Virtual COM" function is required to be "TCP Server". In this mode, the gateway provides a unique "IP: Port" address on a TCP/IP network. It supports up to 4 simultaneous connections, so that multiple hosts can collect data from the same serial device at the same time. After the data has been transferred, the TCP connection will be automatically disconnected from the host computer by using the TCP alive check timeout or idle timeout settings.

UDP Mode

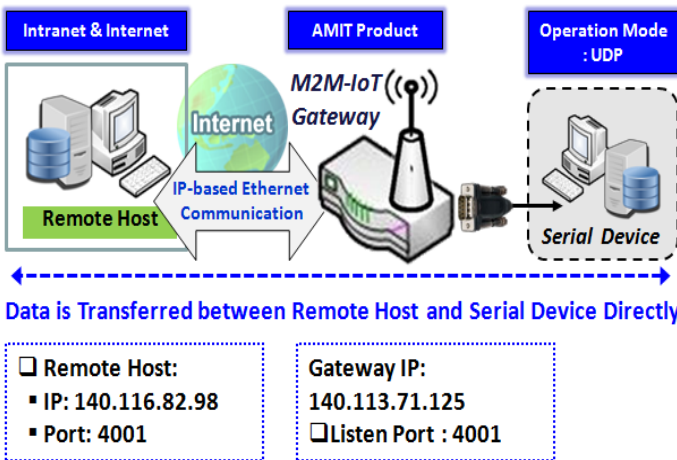

Data is Transferred between Remote Host and Serial Device Directly

to 4 legal hosts to connect simultaneously to the serial device via the gateway.

If both the Remote Host Computer and the serial device are expected to initiate a data transfer when it requires doing that, the operation mode for the "Virtual COM" function in the gateway is required to be "UDP". In this mode, the UDP data can be transferred between the gateway and multiple host computers from either peer, making this mode ideal for message display applications.

The remote host computer can directly send UDP data to the serial device via the gateway, and also receive UDP data from the serial device via the gateway at the same time. The gateway supports up to 4 legal hosts to connect simultaneously to the serial device via the gateway.

4G Vehicle Gateway

RFC-2217 Mode

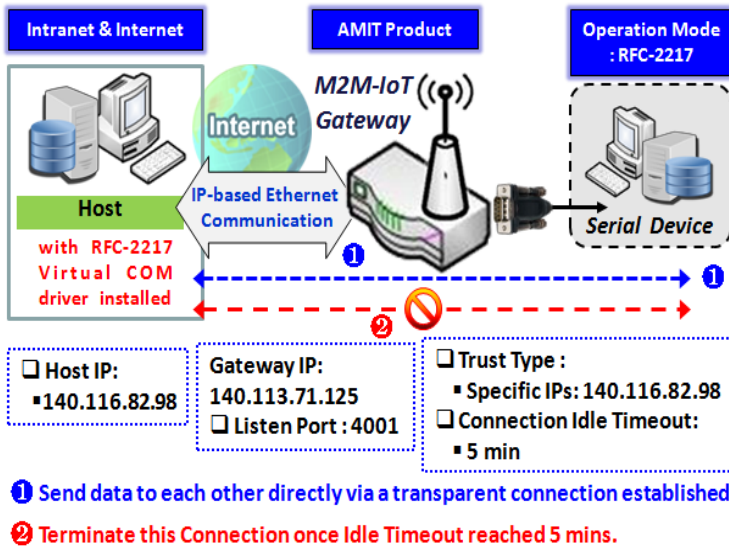

RFC-2217 defines general COM port control options based on telnet protocol. A host computer with RFC-2217 driver installed can monitor and manage the remote serial device attached to the gateway's serial port, as though they were connected to the local serial port. When a virtual serial port on the local serial device is being created, it is required to specify the IP-address of the host computers to establish connection with.

Any 3rd party driver supporting RFC2217 can be used to install in the host computer, the driver establishes a transparent connection between host and serial device by mapping the IP:Port of the gateway's serial port to a virtual local COM

port on the host computer.

The host computer can directly send data to the serial device via the gateway, and also receive data from the serial device via the gateway at the same time. The gateway supports up to 4 Internet host computers.

4G Vehicle Gateway

Virtual COM Setting

Virtual COM setting screen enables user to connect a Virtual COM port based device to the Internet. It allows user to access serial data remotely. There are Disable, TCP Client, TCP Server, UDP, and RFC2217 modes for remote accessing the connected serial device. By default, it is configured in Disable mode.

To use the Virtual COM function, you have to specify the operation mode for the multi-function serial port first. Go to **Field Communication > Bus & Protocol > Port Configuration** tab, select the Virtual COM as expected operation mode, and finish the related port configuration as well.

After that, go to **Field Communication > Bus & Protocol > Virtual COM** tab for detailed configuration of Virtual COM setting.

Enable TCP Client Mode

Configure the gateway as the TCP (Transmission Control Protocol) Client. In TCP Client mode, device initiates a TCP connection with a TCP server when there is data to transmit. Device disconnects from the server when the connection is Idle for a specified period. You may also enable full time connection with the TCP server.

Operation Mode Definition for each Serial Port									
Serial Port	Operation Mode	Listen Port	Trust Type	Max Connection	Connection Control	Connection Idle Timeout	Alive Check Timeout	Enable	Action
SPort-0	TCP Client ▼	4001 (1~65535)	Allow All ▼	1	Always on ▼	0 (0-3600secs)	0 (0-3600secs)	<input type="checkbox"/>	Edit

Enable TCP Client Mode Window		
Item	Value setting	Description
Operation Mode	A Must filled setting	Select TCP Client .
Connection Control	Always on is set by default	Choose Always on for a TCP full time connection. Otherwise, choose On-Demand to initiate TCP connection only when required to transmit and disconnect at idle timeout.
Connection Idle Timeout	1. 0 is set by default 2. Range 0 to 3600 sec.	Enter the idle timeout in minutes. The idle timeout is used to disconnect the TCP connection when idle time elapsed . Idle timeout is only available when On-Demand is selected in the Connection Control field. Value Range: 0 ~ 3600 seconds.
Alive Check Timeout	1. 0 is set by default 2. Range 0 to 3600 sec.	Enter the time period of alive check timeout. The TCP connection will be terminated if it doesn't receive response of alive-check longer than this timeout setting Alive check timeout is only available when On-Demand is selected in the Connection Control field. Value Range: 0 ~ 3600 seconds.
Enable	The box is unchecked by default.	Check the Enable box to activate the corresponding serial port in specified operation mode.
Save	N/A	Click the Save button to save the configuration

4G Vehicle Gateway

Specify Data Packing Parameters

Data Packing (for TCP Client, TCP Server and UDP operation mode)				
Serial Port	Data Buffer Length	Delimiter Character 1	Delimiter Character 2	Data Timeout Transmit
SPort-0	<input type="text" value="0"/> (0~1024)	<input type="text" value="0"/> (Hex) <input type="checkbox"/> Enable	<input type="text" value="0"/> (Hex) <input type="checkbox"/> Enable	<input type="text" value="0"/> (0~1000ms)

Data Packing Configuration		
Item	Value setting	Description
Data Buffer Length	1.An optional filled setting 2.Default value is 0	Enter the data buffer length for the serial port. Value Range: 0 ~ 1024.
Delimiter Character 1	1.An optional filled setting 2.Default value is 0	Check the Enable box to activate the Delimiter character 1, and enter the Hex code for it. Value Range: 0x00 ~ 0xFF.
Delimiter Character 2	1.An optional filled setting 2.Default value is 0	Check the Enable box to activate the Delimiter character 2, and enter the Hex code for it. Value Range: 0x00 ~ 0xFF.
Data Timeout Transmit	1.An optional filled setting 2.Default value is 0	Enter the data timeout interval for transmitting serial data through the port. By default, it is set to 0 and the timeout function is disabled. Value Range: 0 ~ 1000ms.
Save	N/A	Click the Save button to save the configuration

Specify Remote TCP Server

Legal Host IP/ FQDN Definition (for TCP Client operation mode)					
ID	To Remote Host	Remote Port	Serial Port	Definition Enable	Action
1		4001	SPort-0	<input type="checkbox"/>	<input type="button" value="Edit"/>
2		4001	SPort-0	<input type="checkbox"/>	<input type="button" value="Edit"/>
3		4001	SPort-0	<input type="checkbox"/>	<input type="button" value="Edit"/>
4		4001	SPort-0	<input type="checkbox"/>	<input type="button" value="Edit"/>

Specify TCP Server Window		
Item	Value setting	Description
To Remote Host	A Must filled setting	Press Edit button to enter IP address or FQDN of the remote TCP server to transmit serial data.
Remote Port	1.A Must filled setting 2.Default value is 4001	Enter the TCP port number. This is the listen port of the remote TCP server. Value Range: 1 ~ 65535.
Serial Port	SPort-0 is set by default	Apply the TCP server connection for a selected serial port. Up to 4 TCP servers can be configured at the same time for each serial port.
Definition Enable	The box is unchecked by default	Check the Enable box to enable the TCP server configuration.
Save	N/A	Click the Save button to save the configuration

4G Vehicle Gateway

Enable TCP Server Mode

Configure the gateway as the TCP (Transmission Control Protocol) Server. The TCP Server waits for connections to be initiated by a remote TCP client device to receive serial data. The setting allows user to specify specific TCP clients or allow any to send serial data for serial data transmission bandwidth control and access control. The TCP Server supports up to 128 simultaneous connections to receive serial data from multiple TCP clients.

Operation Mode Definition for each Serial Port									
Serial Port	Operation Mode	Listen Port	Trust Type	Max Connection	Connection Control	Connection Idle Timeout	Alive Check Timeout	Enable	Action
SPort-0	TCP Server ▼	4001 (1~65535)	Allow All ▼	1	Always on ▼	0 (0-3600secs)	0 (0-3600secs)	<input type="checkbox"/>	Edit

Enable TCP Server Mode Window		
Item	Value setting	Description
Operation Mode	A Must filled setting	Select TCP Server mode.
Listen Port	4001 is set by default	Indicate the listening port of TCP connection. Value Range: 1 ~ 65535.
Trust Type	Allow All is set by default	Choose Allow All to allow any TCP clients to connect. Otherwise choose Specific IP to limit certain TCP clients.
Max Connection	1. Max. 128 connections 2. 1 is set by default	Set the maximum number of concurrent TCP connections. Up to 128 simultaneous TCP connections can be established. Value Range: 1 ~ 128.
Connection Idle Timeout	1. 0 is set by default 2. Range 0 to 3600 sec.	Enter the idle timeout in minutes. The idle timeout is used to disconnect the TCP connection when idle time elapsed . Idle timeout is only available when On-Demand is selected in the Connection Control field. Value Range: 0 ~ 3600 seconds.
Alive Check Timeout	1. 0 is set by default 2. Range 0 to 3600 sec.	Enter the time period of alive check timeout. The TCP connection will be terminated if it doesn't receive response of alive-check longer than this timeout setting Alive check timeout is only available when On-Demand is selected in the Connection Control field. Value Range: 0 ~ 3600 seconds.
Enable	The box is unchecked by default.	Check the Enable box to activate the corresponding serial port in specified operation mode.
Save	N/A	Click Save button to save the settings.

4G Vehicle Gateway

Specify TCP Clients for TCP Server Access

If you selected **Specific IPs** as the trust Type, the Trusted IP Definition window appears. The settings are valid for both TCP Server and RFC-2217 modes.

Trusted IP Definition (for TCP Server & RFC-2217 operation mode)				
ID	Host	Serial Port	Definition Enable	Action
1			<input type="checkbox"/>	Edit
2			<input type="checkbox"/>	Edit
3			<input type="checkbox"/>	Edit
4			<input type="checkbox"/>	Edit
5			<input type="checkbox"/>	Edit
6			<input type="checkbox"/>	Edit
7			<input type="checkbox"/>	Edit
8			<input type="checkbox"/>	Edit

Specify TCP Clients Window		
Item	Value setting	Description
Host	A Must filled setting	Enter the IP address range of allowed TCP clients.
Serial Port	The box is unchecked by default	Check the box to specify the rule for selected Serial Port.
Definition Enable	The box is unchecked by default	Check the Enable box to enable the rule.
Save	N/A	Click Save to save the settings
Undo	N/A	Click Undo to cancel the settings

4G Vehicle Gateway

Enable UDP Mode

UDP (User Datagram Protocol) enables applications using UDP socket programs to communicate with the serial ports on the serial server. The UDP mode provides connectionless communications, which enable you to multicast data from the serial device to multiple host computers, and vice versa, making this mode ideal for message display applications.

Operation Mode Definition for each Serial Port									
Serial Port	Operation Mode	Listen Port	Trust Type	Max Connection	Connection Control	Connection Idle Timeout	Alive Check Timeout	Enable	Action
SPort-0	UDP	4001 (1~65535)	Allow All	1	Always on	0 (0-3600secs)	0 (0-3600secs)	<input type="checkbox"/>	Edit

Enable UDP Mode Window		
Item	Value setting	Description
Operation Mode	A Must filled setting	Select UDP mode.
Listen Port	4001 is set by default	Indicate the listening port of UDP connection. Value Range: 1 ~ 65535
Enable	The box is unchecked by default.	Check the Enable box to activate the corresponding serial port in specified operation mode.
Save	N/A	Click Save to save the settings
Undo	N/A	Click Undo to cancel the settings

Specify Remote UDP

Legal Host IP Definition (for UDP operation mode)					
ID	Remote Host	Remote Port	Serial Port	Definition Enable	Action
1		4001	SPort-0	<input type="checkbox"/>	Edit
2		4001	SPort-0	<input type="checkbox"/>	Edit
3		4001	SPort-0	<input type="checkbox"/>	Edit
4		4001	SPort-0	<input type="checkbox"/>	Edit

Specify Remote UDP hosts Window		
Item	Value setting	Description
Host	A Must filled setting	Press Edit button to enter IP address range of remote UDP hosts.
Remote Port	4001 is set by default	Indicate the UDP port of peer UDP hosts. Value Range: 1 ~ 65535
Serial Port	SPort-0 is set by default	Apply the UDP hosts for a selected serial port. Up to 4 UDP servers can be configured at the same time for each serial port.
Definition Enable	The box is unchecked by default	Check the Enable box to enable the rule.
Save	N/A	Click Save to save the settings
Undo	N/A	Click Undo to cancel the settings

4G Vehicle Gateway

Enable RFC-2217 Mode

RFC-2217 defines general COM port control options based on telnet protocol. With the RFC-2217 mode, remote host can monitor and manage remote serially attached devices, as though they were connected to the local serial port. When a virtual serial port on the local serial device is being created, it is required to specify the IP-address of the remote hosts to establish connection with.

Operation Mode Definition for each Serial Port									
Serial Port	Operation Mode	Listen Port	Trust Type	Max Connection	Connection Control	Connection Idle Timeout	Alive Check Timeout	Enable	Action
SPort-0	RFC-2217 ▼	4001 (1~65535)	Allow All ▼	1	Always on ▼	0 (0-3600secs)	0 (0-3600secs)	<input type="checkbox"/>	Edit

Enable RFC-2217 Mode Window		
Item	Value setting	Description
Operation Mode	A Must filled setting	Select RFC-2217 mode.
Listen Port	4001 is set by default	Indicate the listening port of RFC-2217 connection. Value Range: 1 ~ 65535
Trust Type	Allow All is set by default	Choose Allow All to allow any clients to connect. Otherwise choose Specific IP to limit certain clients.
Connection Idle Timeout	1. 0 is set by default 2. Range 0 to 3600 sec.	Enter the idle timeout in minutes. The idle timeout is used to disconnect the TCP connection when idle time elapsed . Idle timeout is only available when On-Demand is selected in the Connection Control field. Value Range: 0 ~ 3600 seconds.
Alive Check Timeout	1. 0 is set by default 2. Range 0 to 3600 sec.	Enter the time period of alive check timeout. The TCP connection will be terminated if it doesn't receive response of alive-check longer than this timeout setting Alive check timeout is only available when On-Demand is selected in the Connection Control field. Value Range: 0 ~ 3600 seconds.
Enable	The box is unchecked by default.	Check the Enable box to activate the corresponding serial port in specified operation mode.
Save	N/A	Click Save to save the settings
Undo	N/A	Click Undo to cancel the settings

4G Vehicle Gateway

Specify Remote Host for Access

If you selected **Specific IPs** as the trust Type, the Trusted IP Definition window appears. The settings are valid for both TCP Server and RFC-2217 modes.

Trusted IP Definition (for TCP Server & RFC-2217 operation mode)				
ID	Host	Serial Port	Definition Enable	Action
1			<input type="checkbox"/>	Edit
2			<input type="checkbox"/>	Edit
3			<input type="checkbox"/>	Edit
4			<input type="checkbox"/>	Edit
5			<input type="checkbox"/>	Edit
6			<input type="checkbox"/>	Edit
7			<input type="checkbox"/>	Edit
8			<input type="checkbox"/>	Edit

Specify RFC-2217 Clients for Access Window		
Item	Value setting	Description
Host	A Must filled setting	Enter the IP address range of allowed clients.
Serial Port	The box is unchecked by default	Check the box to specify the rule for selected Serial Port.
Definition Enable	The box is unchecked by default	Check the Enable box to enable the rule.
Save	N/A	Click Save to save the settings
Undo	N/A	Click Undo to cancel the settings

4G Vehicle Gateway

Configure VirtualCOM Data Logging

If you intend to monitor the traffic of the serial port, you can configure the data logging settings and enable it to get the traffic log consequently.

Serial Port	Storage Device	Remote Log Server(UDP)	Upload Server	Data Format	Max Record Day	Enable
SPort-0	External Download <input type="checkbox"/> Enable	IP TX Port 0 RX Port 0 <input type="checkbox"/> Enable	-- Option -- Add Object <input type="checkbox"/> Enable	HEX	3	<input type="checkbox"/>

COM Logging Configuration Window		
Item	Value setting	Description
Storage Device	The box is unchecked by default.	Check the Enable box and use the attached available storage (USB or SD-card) device to keep the data log file under the folder “\virtual-com-log\SPort-n\SDate\”. Click the Download button to get the log files (*.csv).
Remote Log Server (UDP)	The box is unchecked by default.	Check the Enable box and use remote log server to keep the recorded traffic log over the serial port. You have to further specify the IP address and port number for the log server. Value Range: 1 ~ 65535, and 0 for disabled by default.
Upload Server	The box is unchecked by default.	Check the Enable box and select a pre-defined FTP server from the drop down list. You can also click the Add Object button to create a new entry for the server information. The device will auto-upload the logged traffic with a zipped file (*.csv.gz) per hour to the designated FTP server.
Data Format	HEX is set by default	Specify the data format for the logged traffic. It can be HEX or ASCII .
Max Record Day	3 is set by default	Enter the time period of alive check timeout. The TCP connection will be terminated if it doesn't receive response of alive-check longer than this timeout setting Alive check timeout is only available when On-Demand is selected in the Connection Control field. Value Range: 1 ~ 30 days.
Enable	The box is unchecked by default.	Check the Enable box to activate the data logging function for corresponding serial port with specified configuration.
Save	N/A	Click Save to save the settings
Undo	N/A	Click Undo to cancel the settings

Chapter 5 Security

5.1 VPN

A virtual private network (VPN) extends a private network across a public network, such as the Internet. It enables a computer to send and receive data across shared or public networks as if it were directly connected to the private network, while benefitting from the functionality, security and management policies of the private network. This is done by establishing a virtual point-to-point connection through the use of dedicated connections, encryption, or a combination of the two. The tunnel technology supports data confidentiality, data origin authentication and data integrity of network information by utilizing encapsulation protocols, encryption algorithms, and hashing algorithms.

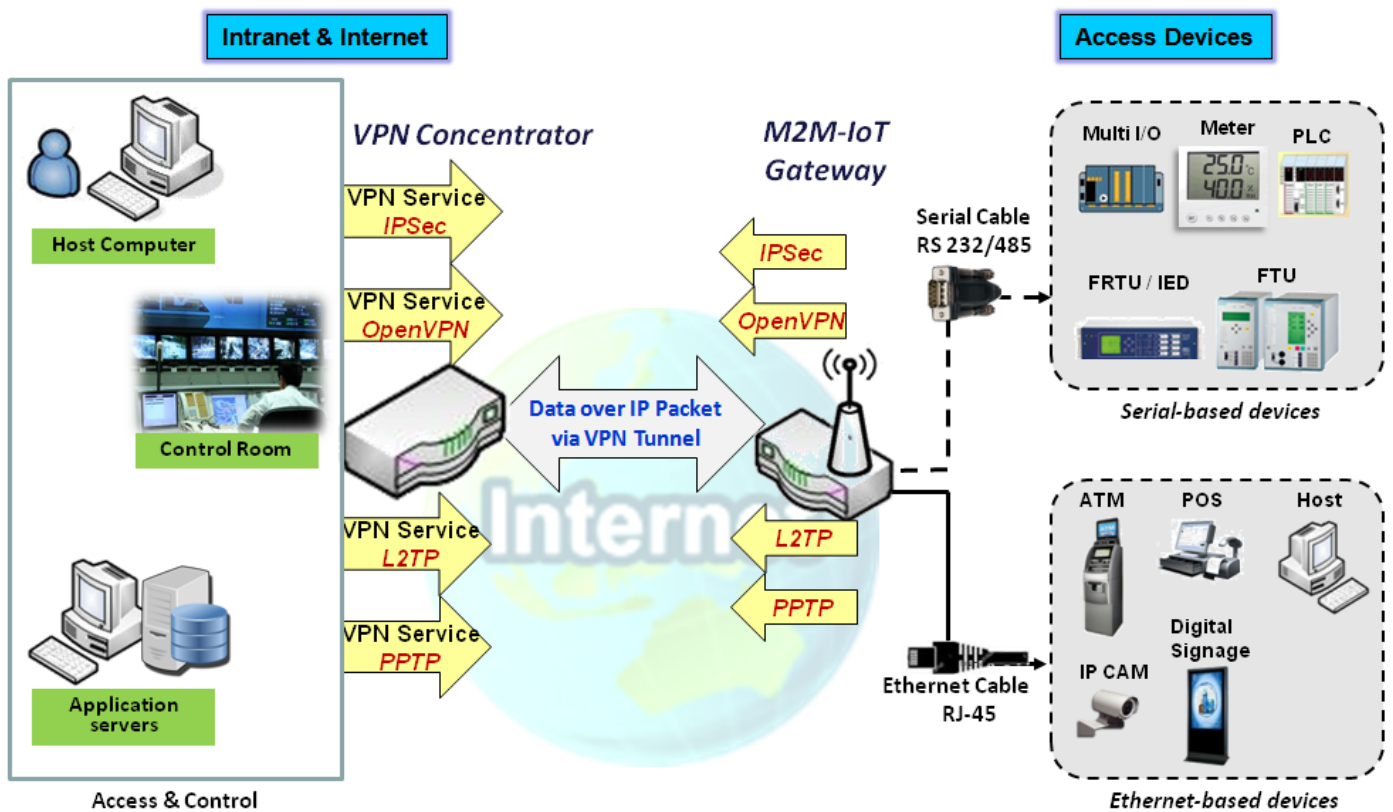

The product series supports different tunneling technologies to establish secure tunnels between multiple sites for data transferring, such as IPSec, OpenVPN, L2TP (over IPSec), PPTP and GRE. Besides, some advanced functions, like Full Tunnel, Tunnel Failover, Tunnel Load Balance, NetBIOS over IPSec, NAT Traversal and Dynamic VPN, are also supported.

4G Vehicle Gateway

5.1.1 IPSec

Internet Protocol Security (IPSec) is a protocol suite for securing Internet Protocol (IP) communications by authenticating and encrypting each IP packet of a communication session. IPSec includes protocols for establishing mutual authentication between agents at the beginning of the session and negotiation of cryptographic keys to be used during the session.

An IPSec VPN tunnel is established between IPSec client and server. Sometimes, we call the IPSec VPN client as the initiator and the IPSec VPN server as the responder. This gateway can be configured as different roles and establish number of tunnels with various remote devices. Before going to setup the VPN connections, you may need to decide the scenario type for the tunneling.

IPSec Tunnel Scenarios

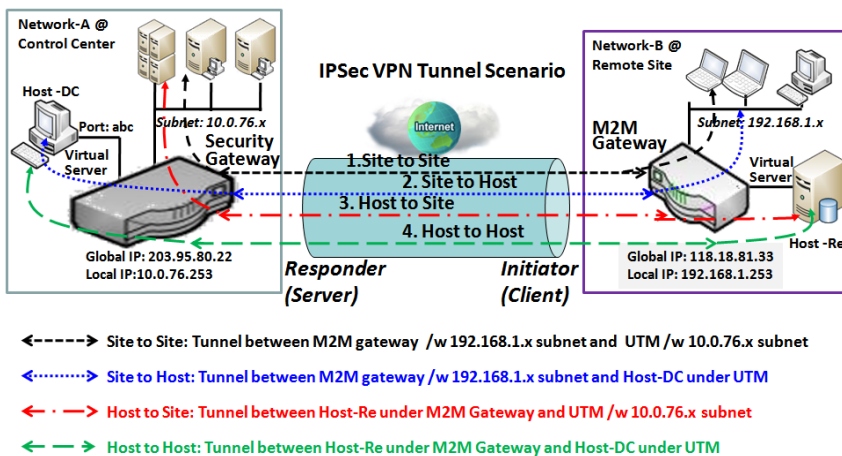

To build IPSec tunnel, you need to fill in remote gateway global IP, and optional subnet if the hosts behind IPSec peer can access to remote site or hosts. Under such configuration, there are four scenarios:

Site to Site: You need to setup remote gateway IP and subnet of both gateways. After the IPSec tunnel established, hosts behind both gateways can communication each other through the tunnel.

Site to Host: Site to Host is suitable for tunneling between clients in a subnet and an application server (host). As in the diagram, the clients behind the M2M gateway can access to the host "Host-DC" located in the control center through Site to Host VPN tunnel.

Host to Site: On the contrast, for a single host (or mobile user to) to access the resources located in an intranet, the Host to Site scenario can be applied.

Host to Host: Host to Host is a special configuration for building a VPN tunnel between two single hosts.

4G Vehicle Gateway

IPSec Setting

Go to **Security > VPN > IPSec** tab.

The IPSec Setting allows user to create and configure IPSec tunnels.

Enable IPSec

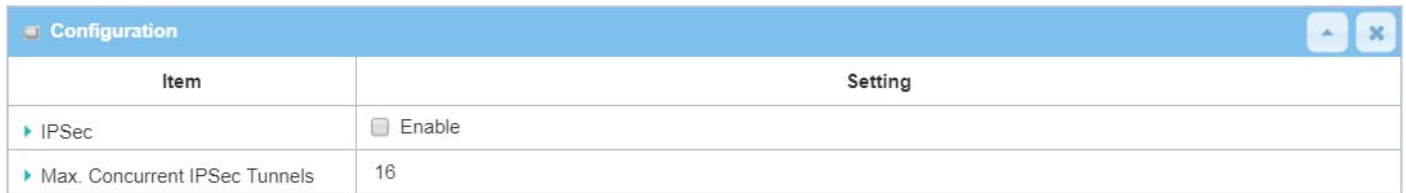

Item	Setting
▶ IPSec	<input type="checkbox"/> Enable
▶ Max. Concurrent IPSec Tunnels	16

Configuration Window		
Item	Value setting	Description
IPsec	Unchecked by default	Click the Enable box to enable IPSec function.
Max. Concurrent IPSec Tunnels	Depends on Product specification.	The specified value will limit the maximum number of simultaneous IPSec tunnel connection. The default value can be different for the purchased model.
Save	N/A	Click Save to save the settings
Undo	N/A	Click Undo to cancel the settings

Create/Edit IPSec tunnel

Ensure that the IPSec enable box is checked to enable before further configuring the IPSec tunnel settings.

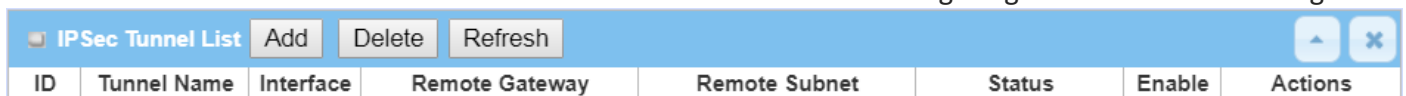

ID	Tunnel Name	Interface	Remote Gateway	Remote Subnet	Status	Enable	Actions
----	-------------	-----------	----------------	---------------	--------	--------	---------

When **Add/Edit** button is applied, a series of configuration screens will appear. They are Tunnel Configuration, Local & Remote Configuration, Authentication, IKE Phase, IKE Proposal Definition, IPSec Phase, and IPSec Proposal Definition. You have to configure the tunnel details for both local and remote VPN devices.

4G Vehicle Gateway

Tunnel Configuration	
Item	Setting
Tunnel	<input type="checkbox"/> Enable
Tunnel Name	IPSec #1
Interface	WAN-1 ▼
Tunnel Scenario	Site-to-Site(Tunnel mode) ▼
Tunnel TCP MSS	Auto ▼ 0 (64~1500 Bytes)
ICMP Keep alive	<input type="checkbox"/> Enable Max. fail times 3 Interval 30 (secs.) Source Addr. Destination Addr.
Encapsulation Protocol	ESP ▼
IKE Version	v1 ▼

Tunnel Configuration Window		
Item	Value setting	Description
Tunnel	Unchecked by default	Check the Enable box to activate the IPSec tunnel
Tunnel Name	1. A Must fill setting 2. String format can be any text	Enter a tunnel name. Enter a name that is easy for you to identify. Value Range: 1 ~ 19 characters.
Interface	1. A Must fill setting 2. WAN 1 is selected by default	Select the interface on which IPSec tunnel is to be established. It can be the available WAN and LAN interfaces.
Tunnel Scenario	1. A Must fill setting 2. Site to site is selected by default	Select an IPSec tunneling scenario from the dropdown box for your application. Select Site-to-Site , Site-to-Host , Host-to-Site , or Host-to-Host . If LAN interface is selected, only Host-to-Host scenario is available. With Site-to-Site or Site-to-Host or Host-to-Site , IPSec operates in tunnel mode. The difference among them is the number of subnets. With Host-to-Host , IPSec operates in transport mode.
Tunnel TCP MSS	1. An optional setting 2. Auto is set by default	Select from the dropdown box to define the size of Tunnel TCP MSS. Select Auto , and all devices will adjust this parameter automatically. Select Manual , and specify an expected value for Tunnel TCP MSS. Value Range: 64 ~ 1500 bytes.
ICMP Keep Alive	1. An optional setting 2. Unchecked by default	Check the Enable box to activate the ICMP keep alive function for the tunnel. If the keep alive function is enabled, you have to define the number of fail trials, check interval, and source/destination IP address for the ICMP packets. Value Range: 1~999 for fail trials and time interval.
Encapsulation Protocol	1. A Must fill setting 2. ESP is selected by default	Select the Encapsulation Protocol from the dropdown box for this IPSec tunnel. Available encapsulations are ESP and AH .
IKE Version	1. A Must fill setting 2. v1 is selected by default	Specify the IKE version for this IPSec tunnel. Select v1 or v2 .

4G Vehicle Gateway

Local & Remote Configuration				
Item	Setting			
Local Subnet List	ID	Subnet IP Address	Subnet Mask	Actions
	1	<input type="text" value="192.168.66.0"/>	<input type="text" value="255.255.255.0(24)"/>	<input type="button" value="Delete"/>
	<input type="button" value="Add"/>			
Remote Subnet List	ID	Subnet IP Address	Subnet Mask	Actions
	1	<input type="text"/>	<input type="text" value="255.255.255.0(24)"/>	<input type="button" value="Delete"/>
	<input type="button" value="Add"/>			
Remote Gateway	<input type="text" value=""/> (IP Address/FQDN)			

Local & Remote Configuration Window		
Item	Value setting	Description
Local Subnet List	A Must fill setting	<p>Specify the Local Subnet IP address and Subnet Mask. Click the Add or Delete button to add or delete a Local Subnet.</p> <p>Note_1: When Dynamic VPN option in Tunnel Scenario is selected, there will be only one subnet available. Note_2: When Host-to-Site or Host-to-Host option in Tunnel Scenario is selected, Local Subnet will not be available. Note_3: When Hub and Spoke option in Hub and Spoke is selected, there will be only one subnet available.</p>
Remote Subnet List	A Must fill setting	<p>Specify the Remote Subnet IP address and Subnet Mask. Click the Add or Delete button to add or delete Remote Subnet setting.</p>
Remote Gateway	1. A Must fill setting. 2. Format can be a ipv4 address or FQDN	Specify the Remote Gateway.

Authentication	
Item	Setting
Key Management	<input type="text" value="IKE+Pre-shared Key"/> (Min. 8 characters)
Local ID	Type: <input type="text" value="User Name"/> ID: <input type="text"/> (Optional)
Remote ID	Type: <input type="text" value="User Name"/> ID: <input type="text"/>

Authentication Configuration Window		
Item	Value setting	Description
Key Management	1. A Must fill setting 2. Pre-shared Key 8 to 32 characters.	<p>Select Key Management from the dropdown box for this IPsec tunnel.</p> <p>IKE+Pre-shared Key: user needs to set a key (8 ~ 32 characters). IKE+X.509: user needs Certificate to authenticate. IKE+X.509 will be available only when Certificate has been configured properly. Refer to Certificate section of this manual and also Object Definition > Certificate in web-based utility.</p>
Local ID	An optional setting	<p>Specify the Local ID for this IPsec tunnel to authenticate.</p> <p>Select User Name for Local ID and enter the username. The username may include but can't be all numbers. Select FQDN for Local ID and enter the FQDN. Select User@FQDN for Local ID and enter the User@FQDN.</p>

4G Vehicle Gateway

Remote ID	An optional setting	<p>Select Key ID for Local ID and enter the Key ID (English alphabet or number).</p> <p>Specify the Remote ID for this IPSec tunnel to authenticate.</p> <p>Select User Name for Remote ID and enter the username. The username may include but can't be all numbers.</p> <p>Select FQDN for Local ID and enter the FQDN.</p> <p>Select User@FQDN for Remote ID and enter the User@FQDN.</p> <p>Select Key ID for Remote ID and enter the Key ID (English alphabet or number).</p> <p>Note: Remote ID will be not available when Dynamic VPN option in Tunnel Scenario is selected.</p>
------------------	---------------------	--

IKE Phase	
Item	Setting
▶ Negotiation Mode	Main Mode ▾
▶ X-Auth	None ▾ X-Auth Account (Optional) User Name : <input type="text"/> Password : <input type="text"/>
▶ Dead Peer Detection (DPD)	<input checked="" type="checkbox"/> Enable Timeout : <input type="text" value="180"/> (seconds) Delay : <input type="text" value="30"/> (seconds)
▶ Phase1 Key Life Time	<input type="text" value="3600"/> (seconds) (Max. 86400)

IKE Phase Window		
Item	Value setting	Description
Negotiation Mode	Main Mode is set by default default	Specify the Negotiation Mode for this IPSec tunnel. Select Main Mode or Aggressive Mode .
X-Auth	None is selected by default	Specify the X-Auth role for this IPSec tunnel. Select Server, Client, or None. Selected None no X-Auth authentication is required. Selected Server this gateway will be an X-Auth server. Click on the X-Auth Account button to create remote X-Auth client account. Selected Client this gateway will be an X-Auth client. Enter User name and Password to be authenticated by the X-Auth server gateway. Note: X-Auth Client will not be available for Dynamic VPN option selected in Tunnel Scenario.
Dead Peer Detection (DPD)	1. Checked by default 2. Default Timeout 180s and Delay 30s	Click Enable box to enable DPD function. Specify the Timeout and Delay time in seconds. Value Range: 0 ~ 999 seconds for Timeout and Delay.
Phase1 Key Life Time	1. A Must fill setting 2. Default 3600s 3. Max. 86400s	Specify the Phase1 Key Life Time. Value Range: 30 ~ 86400.

IKE Proposal Definition				
ID	Encryption	Authentication	DH Group	Definition
1	AES-128 ▾	SHA1 ▾	Group 2 ▾	<input checked="" type="checkbox"/> Enable
2	AES-128 ▾	MD5 ▾	Group 2 ▾	<input checked="" type="checkbox"/> Enable
3	DES ▾	SHA1 ▾	Group 2 ▾	<input checked="" type="checkbox"/> Enable
4	3DES ▾	SHA1 ▾	Group 2 ▾	<input checked="" type="checkbox"/> Enable

IKE Proposal Definition Window

4G Vehicle Gateway

Item	Value setting	Description
IKE Proposal Definition	A Must fill setting	Specify the Phase 1 Encryption method. It can be DES / 3DES / AES-128 / AES-192 / AES-256.
		Specify the Authentication method. It can be None / MD5 / SHA1 / SHA2-256.
		Specify the DH Group. It can be None / Group1 / Group2 / Group5 / Group14 / Group15 / Group16 / Group17 / Group18.
		Check Enable box to enable this setting

IPSec Phase	
Item	Setting
Phase2 Key Life Time	28800 (seconds) (Max. 86400)

IPSec Phase Window		
Item	Value setting	Description
Phase2 Key Life Time	1. A Must fill setting 2. 28800s is set by default 3. Max. 86400s	Specify the Phase2 Key Life Time in second. Value Range: 30 ~ 86400.

IPSec Proposal Definition				
ID	Encryption	Authentication	PFS Group	Definition
1	AES-128 ▼	SHA1 ▼	Group 2 ▼	<input checked="" type="checkbox"/> Enable
2	AES-128 ▼	MD5 ▼		<input checked="" type="checkbox"/> Enable
3	DES ▼	SHA1 ▼		<input checked="" type="checkbox"/> Enable
4	3DES ▼	SHA1 ▼		<input checked="" type="checkbox"/> Enable

IPSec Proposal Definition Window		
Item	Value setting	Description
IPSec Proposal Definition	A Must fill setting	Specify the Encryption method. It can be DES / 3DES / AES-128 / AES-192 / AES-256. Note: None is available when Encapsulation Protocol is set as AH .
		Specify the Authentication method. It can be None / MD5 / SHA1 / SHA2-256. Note: None and SHA2-256 are available only when Encapsulation Protocol is set as ESP ; they are not available for AH Encapsulation.
		Specify the PFS Group. It can be None / Group1 / Group2 / Group5 / Group14 / Group15 / Group16 / Group17 / Group18.
		Click Enable to enable this setting
Save	N/A	Click Save to save the settings
Undo	N/A	Click Undo to cancel the settings

4G Vehicle Gateway

Back N/A Click **Back** to return to the previous page.

Create/Edit Dynamic VPN Server List

Dynamic VPN List ⏪ ⏩

Similar to create an IPsec VPN Tunnel for site/host to site/host scenario, when **Add / Edit** button is applied a series of configuration screen will appear. They are Tunnel Configuration, Local & Remote Configuration, Authentication, IKE Phase, IKE Proposal Definition, IPsec Phase, and IPsec Proposal Definition. You have to configure the tunnel details for the gateway as a Dynamic VPN server.

Note: For the purchased gateway, you can configure one Dynamic VPN server for each WAN interface.

Tunnel Configuration	
Item	Setting
▶ Tunnel	<input type="checkbox"/> Enable
▶ Tunnel Name	Dynamic IPsec1
▶ Interface	WAN1 ▼
▶ Tunnel Scenario	Tunnel Mode ▼
▶ Encapsulation Protocol	ESP ▼
▶ IKE Version	v1 ▼

Tunnel Configuration Window		
Item	Value setting	Description
Tunnel	Unchecked by default	Check the Enable box to activate the Dynamic IPsec VPN tunnel.
Tunnel Name	1. A Must fill setting 2. String format can be any text	Enter a tunnel name. Enter a name that is easy for you to identify. Value Range: 1 ~ 19 characters.
Interface	1. A Must fill setting 2. WAN 1 is selected by default	Select WAN interface on which IPsec tunnel is to be established.
Tunnel Scenario	1. A Must fill setting 2. Tunnel Mode is selected by default	Select the Dynamic IPsec tunneling scenario. It can be Tunnel Mode or Transport Mode .
Encapsulation Protocol	1. A Must fill setting 2. ESP is selected by default	Select the Encapsulation Protocol from the dropdown box for this IPsec tunnel. Available encapsulations are ESP and AH .
IKE Version	1. A Must fill setting 2. v1 is selected by default	Specify the IKE version for this IPsec tunnel.

4G Vehicle Gateway

Local & Remote Configuration	
Item	Setting
Local Subnet	192.168.66.0
Local Netmask	255.255.255.0(24) ▼

Local & Remote Configuration Window		
Item	Value setting	Description
Local Subnet	A Must fill setting	Specify the Local Subnet IP address.
Local Netmask	A Must fill setting	Specify the Local Subnet Mask.

Authentication	
Item	Setting
Key Management	IKE+Pre-shared Key ▼ <input type="text"/> (Min. 8 characters)
Local ID	Type: User Name ▼ ID: <input type="text"/> (Optional)
Remote ID	Type: User Name ▼ ID: <input type="text"/>

Authentication Configuration Window		
Item	Value setting	Description
Key Management	1. A Must fill setting 2. Pre-shared Key 8 to 32 characters.	Select Key Management from the dropdown box for this IPsec tunnel. IKE+Pre-shared Key : user needs to set a key (8 ~ 32 characters).
Local ID	An optional setting	Specify the Local ID for this IPsec tunnel to authenticate. Select User Name for Local ID and enter the username. The username may include but can't be all numbers. Select FQDN for Local ID and enter the FQDN. Select User@FQDN for Local ID and enter the User@FQDN. Select Key ID for Local ID and enter the Key ID (English alphabet or number).
Remote ID	An optional setting	Specify the Remote ID for this IPsec tunnel to authenticate. Select User Name for Remote ID and enter the username. The username may include but can't be all numbers. Select FQDN for Local ID and enter the FQDN. Select User@FQDN for Remote ID and enter the User@FQDN. Select Key ID for Remote ID and enter the Key ID (English alphabet or number). Note: Remote ID will be not available when Dynamic VPN option in Tunnel Scenario is selected.

For the rest IKE Phase, IKE Proposal Definition, IPsec Phase, and IPsec Proposal Definition settings, they are the same as that of creating an IPsec Tunnel described in previous section. Please refer to the related description.

4G Vehicle Gateway

5.1.2 OpenVPN

OpenVPN is an application that implements virtual private network (VPN) techniques for creating secure point-to-point or site-to-site connections in routed or bridged configurations and remote access facilities. It uses a custom security protocol that utilizes SSL/TLS for key exchange. It is capable of traversing network address translators (NATs) and firewalls.

OpenVPN allows peers to authenticate each other using a Static Key (pre-shared key) or certificates. When used in a multi-client-server configuration, it allows the server to release an authentication certificate for every client, using signature and certificate authority. It uses the OpenSSL encryption library extensively, as well as the SSLv3/TLSv1 protocol, and contains many security and control features.

OpenVPN Tunneling is a Client and Server based tunneling technology. The OpenVPN Server must have a Static IP or a FQDN, and maintain a Client list. The OpenVPN Client may be a mobile user or mobile site with public IP or private IP, and requesting the OpenVPN tunnel connection. The product supports both OpenVPN Server and OpenVPN Client features to meet different application requirements.

There are two OpenVPN connection scenarios. They are the TAP and TUN scenarios. The product can create either a layer-3 based IP tunnel (TUN), or a layer-2 based Ethernet TAP that can carry any type of Ethernet traffic. In addition to configuring the device as a Server or Client, you have to specify which type of OpenVPN connection scenario is to be adopted.

OpenVPN TUN Scenario

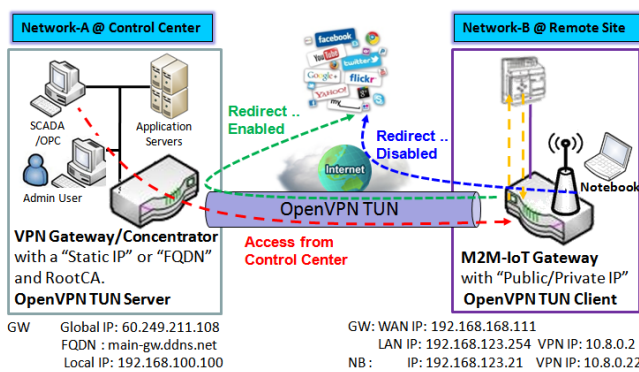

1. M2M-IoT Gateway (as OpenVPN TUN Client) connects to peer VPN Gateway/Concentrator (as OpenVPN TUN Server).
2. M2M-IoT Gateway will be assigned 10.8.0.2 IP Address after OpenVPN TUN Connection established. (10.8.0.x is a virtual subnet)
3. Local networked device will get a virtual IP 10.8.0.x if its traffic goes through the OpenVPN TUN connection (when NAT disabled & Redirect Internet Traffic enabled).
4. SCADA Server in Control Center can access remote attached device(s) with the assigned IP Address 10.8.0.2.

solution.

As shown in the diagram, the M2M-IoT Gateway is configured as an OpenVPN TUN Client, and connects to an

The term "TUN" mode is referred to routing mode and operates with layer 3 packets. In routing mode, the VPN client is given an IP address on a different subnet than the local LAN under the OpenVPN server. This virtual subnet is created for connecting to any remote VPN computers. In routing mode, the OpenVPN server creates a "TUN" interface with its own IP address pool which is different to the local LAN. Remote hosts that dial-in will get an IP address inside the virtual network and will have access only to the server where OpenVPN resides.

If you want to offer remote access to a VPN server from client(s), and inhibit the access to remote LAN resources under VPN server, OpenVPN TUN mode is the simplest

4G Vehicle Gateway

OpenVPN UN Server. Once the OpenVPN TUN connection is established, the connected TUN client will be assigned a virtual IP (10.8.0.2) which is belong to a virtual subnet that is different to the local subnet in Control Center. With such connection, the local networked devices will get a virtual IP 10.8.0.x if its traffic goes through the OpenVPN TUN connection when Redirect Internet Traffic settings is enabled; Besides, the SCADA Server in Control Center can access remote attached serial device(s) with the virtual IP address (10.8.0.2).

OpenVPN TAP Scenario

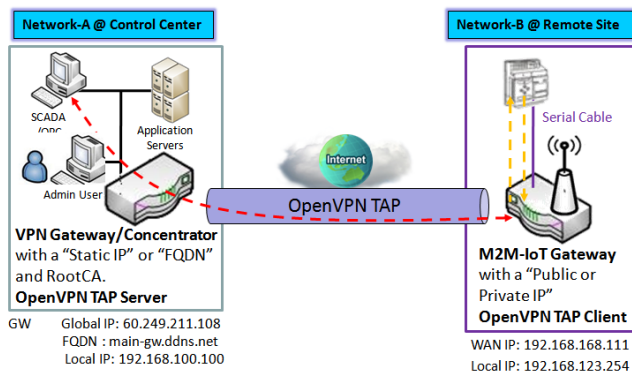

1. M2M-IoT Gateway (as OpenVPN TAP Client) connects to peer VPN Gateway/Concentrator (as OpenVPN TAP Server).
2. M2M-IoT Gateway will be assigned **192.168.100.210** IP Address after OpenVPN TAP Connection established. (same subnet as in Control Center)
3. SCADA Server in Control Center can access remote attached device(s) with the assigned IP Address 192.168.100.210.

The term "TAP" is referred to bridge mode and operates with layer 2 packets. In bridge mode, the VPN client is given an IP address on the same subnet as the LAN resided under the OpenVPN server. Under such configuration, the OpenVPN client can directly access to the resources in LAN. If you want to offer remote access to the entire remote LAN for VPN client(s), you have to setup OpenVPN in "TAP" bridge mode.

As shown in the diagram, the M2M-IoT Gateway is configured as an OpenVPN TAP Client, and connects to an OpenVPN TAP Server. Once the OpenVPN TAP connection is established, the connected TAP client will be assigned a virtual IP (192.168.100.210) which is the same subnet as

that of local subnet in Control Center. With such connection, the SCADA Server in Control Center can access remote attached device(s) with the virtual IP address (192.168.100.210).

4G Vehicle Gateway

Open VPN Setting

Go to **Security > VPN > OpenVPN** tab.

The OpenVPN setting allows user to create and configure OpenVPN tunnels.

Enable OpenVPN

Enable OpenVPN and select an expected configuration, either server or client, for the gateway to operate.

Configuration	
Item	Setting
▶ OpenVPN	<input checked="" type="checkbox"/> Enable
▶ Server / Client	Server ▼

Configuration		
Item	Value setting	Description
OpenVPN	The box is unchecked by default	Check the Enable box to activate the OpenVPN function.
Server/Client	Server Configuration is selected by default.	When Server is selected, as the name indicated, server configuration will be displayed below for further setup. When Client is selected, you can specify the client settings in another client configuration window.

4G Vehicle Gateway

As an OpenVPN Server

If **Server** is selected, an OpenVPN Server Configuration screen will appear. **OpenVPN Server Configuration** window can let you enable the OpenVPN server function, specify the virtual IP address of OpenVPN server, when remote OpenVPN clients dial in, and the authentication protocol.

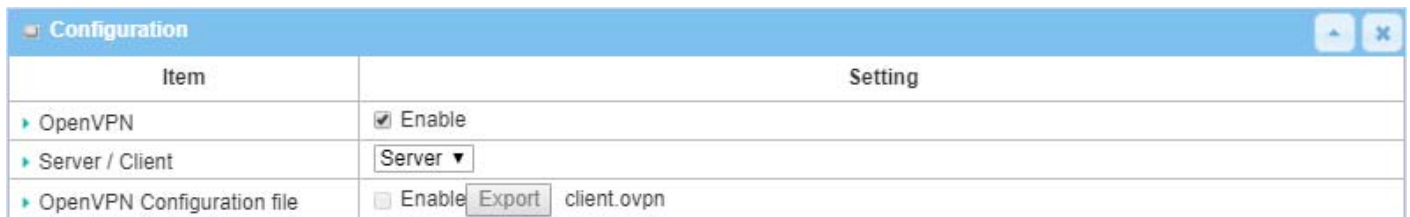

Item	Setting
▶ OpenVPN	<input checked="" type="checkbox"/> Enable
▶ Server / Client	Server ▾
▶ OpenVPN Configuration file	<input type="checkbox"/> Enable <input type="button" value="Export"/> client.ovpn

Configuration		
Item	Value setting	Description
OpenVPN Configuration File	1. An Optional setting. 2. The box is unchecked by default.	Click the Enable box to activate the export feature of OpenVPN Client configuration to a .ovpn file. You have to further click the Export button to get the configuration file.

The OpenVPN Server supports up to 4 TUN / TAP tunnels at the same time.

4G Vehicle Gateway

OpenVPN Server Configuration	
Item	Setting
▶ OpenVPN Server	<input type="checkbox"/> Enable
▶ Protocol	TCP ▼
▶ Port	4430
▶ Tunnel Scenario	TUN ▼
▶ Authorization Mode	TLS ▼ CA Cert.: amit-IDG761AM-JH.crt ▼ Server Cert.: LocalCert1 ▼
▶ Server Virtual IP	10.8.0.0
▶ DHCP-Proxy Mode	<input checked="" type="checkbox"/> Enable
▶ IP Pool	Starting Address: <input type="text"/> ~ Ending Address: <input type="text"/>
▶ Gateway	<input type="text"/>
▶ Netmask	255.255.255.0(/24) ▼
▶ Redirect Default Gateway	<input type="checkbox"/> Enable
▶ Encryption Cipher	Blowfish ▼
▶ Hash Algorithm	SHA-1 ▼
▶ LZO Compression	Adaptive ▼
▶ Persist Key	<input checked="" type="checkbox"/> Enable
▶ Persist Tun	<input checked="" type="checkbox"/> Enable
▶ Advanced Configuration	<input type="button" value="Edit"/>

OpenVPN Server Configuration		
Item	Value setting	Description
OpenVPN Server	The box is unchecked by default.	Click the Enable to activate OpenVPN Server functions.
Protocol	<ol style="list-style-type: none"> A Must filled setting By default TCP is selected. 	Define the selected Protocol for connecting to the OpenVPN Server. <ul style="list-style-type: none"> Select TCP, or UDP -> The TCP protocol will be used to access the OpenVPN Server, and Port will be set as 4430 automatically. Select UDP -> The UDP protocol will be used to access the OpenVPN Server, and Port will be set as 1194 automatically.
Port	<ol style="list-style-type: none"> A Must filled setting By default 4430 is set. 	Specify the Port for connecting to the OpenVPN Server. Value Range: 1 ~ 65535.
Tunnel Scenario	<ol style="list-style-type: none"> A Must filled setting By default TUN is selected. 	Specify the type of Tunnel Scenario for connecting to the OpenVPN Server. It can be TUN for TUN tunnel scenario, or TAP for TAP tunnel scenario.
Authorization Mode	<ol style="list-style-type: none"> A Must filled setting By default TLS is selected. 	Specify the authorization mode for the OpenVPN Server. <ul style="list-style-type: none"> TLS ->The OpenVPN will use TLS authorization mode, and the following items CA Cert., Server Cert. and DH PEM will be displayed.

4G Vehicle Gateway

		<p>CA Cert. could be generated in Certificate. Refer to Object Definition > Certificate > Trusted Certificate.</p> <p>Server Cert. could be generated in Certificate. Refer to Object Definition > Certificate > My Certificate.</p> <ul style="list-style-type: none"> • Static Key <p>->The OpenVPN will use static key (pre-shared) authorization mode, and the following items Local Endpoint IP Address, Remote Endpoint IP Address and Static Key will be displayed.</p> <p>Note: Static Key will be available only when TUN is chosen in Tunnel Scenario.</p>
Local Endpoint IP Address	A Must filled setting	<p>Specify the virtual Local Endpoint IP Address of this OpenVPN gateway.</p> <p>Value Range: The IP format is 10.8.0.x, the range of x is 1~254.</p> <p>Note: Local Endpoint IP Address will be available only when Static Key is chosen in Authorization Mode.</p>
Remote Endpoint IP Address	A Must filled setting	<p>Specify the virtual Remote Endpoint IP Address of the peer OpenVPN gateway.</p> <p>Value Range: The IP format is 10.8.0.x, the range of x is 1~254.</p> <p>Note: Remote Endpoint IP Address will be available only when Static Key is chosen in Authorization Mode.</p>
Static Key	A Must filled setting	<p>Specify the Static Key.</p> <p>Note: Static Key will be available only when Static Key is chosen in Authorization Mode.</p>
Server Virtual IP	A Must filled setting	<p>Specify the Server Virtual IP.</p> <p>Value Range: The IP format is 10.y.0.0, the range of y is 1~254.</p> <p>Note: Server Virtual IP will be available only when TLS is chosen in Authorization Mode.</p>
DHCP-Proxy Mode	1. A Must filled setting 2. The box is checked by default.	<p>Check the Enable box to activate the DHCP-Proxy Mode.</p> <p>Note: DHCP-Proxy Mode will be available only when TAP is chosen in Tunnel Device.</p>
IP Pool	A Must filled setting	<p>Specify the virtual IP pool setting for the OpenVPN server. You have to specify the Starting Address and Ending Address as the IP address pool for the OpenVPN clients.</p> <p>Note: IP Pool will be available only when TAP is chosen in Tunnel Device, and DHCP-Proxy Mode is unchecked (disabled).</p>
Gateway	A Must filled setting	<p>Specify the Gateway setting for the OpenVPN server. It will be assigned to the connected OpenVPN clients.</p> <p>Note: Gateway will be available only when TAP is chosen in Tunnel Device, and DHCP-Proxy Mode is unchecked (disabled).</p>
Netmask	By default - select one - is selected.	<p>Specify the Netmask setting for the OpenVPN server. It will be assigned to the connected OpenVPN clients.</p> <p>Value Range: 255.255.255.0/24 (only support class C)</p> <p>Note_1: Netmask will be available when TAP is chosen in Tunnel Device, and DHCP-Proxy Mode is unchecked (disabled).</p> <p>Note_2: Netmask will also be available when TUN is chosen in Tunnel Device.</p>
Redirect Default Gateway	1. An Optional setting. 2. The box is unchecked by default.	<p>Check the Enable box to activate the Redirect Default Gateway function.</p>
Encryption Cipher	1. A Must filled setting. 2. By default Blowfish is selected.	<p>Specify the Encryption Cipher from the dropdown list.</p> <p>It can be Blowfish/AES-256/AES-192/AES-128/None.</p>
Hash Algorithm	By default SHA-1 is selected.	<p>Specify the Hash Algorithm from the dropdown list.</p> <p>It can be SHA-1/MD5/MD4/SHA2-256/SHA2-512/None/Disable.</p>
LZO	By default Adaptive is	<p>Specify the LZO Compression scheme.</p>

4G Vehicle Gateway

Compression	selected.	It can be Adaptive/YES/NO/Default .
Multicast	1. An Optional setting. 2. The box is checked by default.	Check the Enable box to activate the Multicast function. Note: Multicast function is only available for TAP tunnel scenario.
Persis Key	1. An Optional setting. 2. The box is checked by default.	Check the Enable box to activate the Persis Key function.
Persis Tun	1. An Optional setting. 2. The box is checked by default.	Check the Enable box to activate the Persis Tun function.
Advanced Configuration	N/A	Click the Edit button to specify the Advanced Configuration setting for the OpenVPN server. If the button is clicked, Advanced Configuration will be displayed below.
Save	N/A	Click Save to save the settings.
Undo	N/A	Click X to cancel the changes and return to last page.

4G Vehicle Gateway

When **Advanced Configuration** is selected, an OpenVPN Server Advanced Configuration screen will appear.

OpenVPN Server Advanced Configuration	
Item	Setting
▶ TLS Cipher	None
▶ TLS Auth. Key	<input type="text"/> (Optional)
▶ Client to Client	<input checked="" type="checkbox"/> Enable
▶ Duplicate CN	<input checked="" type="checkbox"/> Enable
▶ Tunnel MTU	1500
▶ Tunnel UDP Fragment	0
▶ Tunnel UDP MSS-Fix	<input type="checkbox"/> Enable
▶ CCD-Dir Default File	<input type="text"/>
▶ Client Connection Script	<input type="text"/>
▶ Additional Configuration	<input type="text"/>

OpenVPN Server Advanced Configuration		
Item	Value setting	Description
TLS Cipher	1. A Must filled setting. 2. TLS-RSA-WITH-AES128-SHA is selected by default	Specify the TLS Cipher from the dropdown list. It can be None / TLS-RSA-WITH-RC4-MD5 / TLS-RSA-WITH-AES128-SHA / TLS-RSA-WITH-AES256-SHA / TLS-DHE-DSS-AES128-SHA / TLS-DHE-DSS-AES256-SHA . Note: TLS Cipher will be available only when TLS is chosen in Authorization Mode.
TLS Auth. Key	1. An Optional setting. 2. String format: any text	Specify the TLS Auth. Key . Note: TLS Auth. Key will be available only when TLS is chosen in Authorization Mode.
Client to Client	The box is checked by default	Check the Enable box to enable the traffics among different OpenVPN Clients. Note: Client to Client will be available only when TLS is chosen in Authorization Mode
Duplicate CN	The box is checked by default	Check the Enable box to activate the Duplicate CN function. Note: Duplicate CN will be available only when TLS is chosen in Authorization Mode
Tunnel MTU	1. A Must filled setting 2. The value is 1500 by default	Specify the Tunnel MTU . Value Range: 0 ~ 1500.
Tunnel UDP	1. A Must filled setting	Specify the Tunnel UDP Fragment . By default, it is equal to Tunnel MTU .

4G Vehicle Gateway

Fragment	2. The value is 1500 by default	<i>Value Range:</i> 0 ~ 1500. Note: Tunnel UDP Fragment will be available only when UDP is chosen in Protocol.
Tunnel UDP MSS-Fix	1. An Optional setting. 2. The box is unchecked by default.	Check the Enable box to activate the Tunnel UDP MSS-Fix Function. Note: Tunnel UDP MSS-Fix will be available only when UDP is chosen in Protocol.
CCD-Dir Default File	1. An Optional setting. 2. String format: any text	Specify the CCD-Dir Default File . <i>Value Range:</i> 0 ~ 256 characters.
Client Connection Script	1. An Optional setting. 2. String format: any text	Specify the Client Connection Script . <i>Value Range:</i> 0 ~ 256 characters.
Additional Configuration	1. An Optional setting. 2. String format: any text	Specify the Additional Configuration . <i>Value Range:</i> 0 ~ 256 characters.

4G Vehicle Gateway

As an OpenVPN Client

If **Client** is selected, the configuration screen will be changed as below and an OpenVPN Client List screen appear.

Configuration	
Item	Setting
▶ OpenVPN	<input type="checkbox"/> Enable
▶ Server / Client	Client ▾
▶ OpenVPN Configuration file	<input type="checkbox"/> Enable <input type="button" value="Upgrade"/> Interface WAN-1 ▾

OpenVPN Configuration		
Item	Value setting	Description
OpenVPN	The box is unchecked by default	Check the Enable box to activate the OpenVPN function.
Server/Client	Server Configuration is selected by default.	When Server is selected, as the name indicated, server configuration will be displayed below for further setup. When Client is selected, you can specify the client settings in another client configuration window.
OpenVPN Configuration file	1. An Optional setting. 2. The box is unchecked by default.	Click the Enable box to activate the OpenVPN Client configuration via a pre-defined configuration file. You have to further specify the Interface to be applied, and click the Upgrade button to upload the configuration from a .ovpn file. If you enabled this function, you can't add any OpenVPN clients manually.

OpenVPN Client List														
ID	Client Name	Interface	Protocol	Port	Tunnel Scenario	Remote IP/FQDN	Remote Subnet	Redirect Internet Traffic	NAT	Authorization Mode	Encryption Cipher	Hash Algorithm	Enable	Actions

When **Add** button is applied, OpenVPN Client Configuration screen will appear. **OpenVPN Client Configuration** window let you specify the required parameters for an OpenVPN VPN client, such as "OpenVPN Client Name", "Interface", "Protocol", "Tunnel Scenario", "Remote IP/FQDN", "Remote Subnet", "Authorization Mode", "Encryption Cipher", "Hash Algorithm" and tunnel activation.

4G Vehicle Gateway

OpenVPN Client Configuration	
Item	Setting
▶ OpenVPN Client Name	OpenVPN Client #1
▶ Interface	WAN 1 ▼
▶ Protocol	TCP ▼ Port: 443
▶ Tunnel Scenario	TUN ▼
▶ Remote IP/FQDN	
▶ Remote Subnet	<input type="checkbox"/> Enable <input type="text" value="255.255.255.0"/> 255.255.255.0(/24) ▼
▶ Redirect Internet Traffic	<input type="checkbox"/> Enable
▶ NAT	<input checked="" type="checkbox"/> Enable
▶ Authorization Mode	TLS ▼ CA Cert.: ▼ Client Cert.: ▼ Client Key.: ▼ Please set the Certificate.
▶ Encryption Cipher	Blowfish ▼
▶ Hash Algorithm	SHA-1 ▼
▶ LZO Compression	Adaptive ▼
▶ Persist Key	<input checked="" type="checkbox"/> Enable
▶ Persist Tun	<input checked="" type="checkbox"/> Enable
▶ Advanced Configuration	Edit
▶ Tunnel	<input type="checkbox"/> Enable

OpenVPN Client Configuration		
Item	Value setting	Description
OpenVPN Client Name	A Must filled setting	The OpenVPN Client Name will be used to identify the client in the tunnel list. Value Range: 1 ~ 32 characters.
Interface	1. A Must filled setting 2. By default WAN-1 is selected.	Define the physical interface to be used for this OpenVPN Client tunnel.
Protocol	1. A Must filled setting 2. By default TCP is selected.	Define the Protocol for the OpenVPN Client. <ul style="list-style-type: none"> • Select TCP ->The OpenVPN will use TCP protocol, and Port will be set as 443 automatically. • Select UDP -> The OpenVPN will use UDP protocol, and Port will be set as 1194 automatically.
Port	1. A Must filled setting 2. By default 443 is set.	Specify the Port for the OpenVPN Client to use. Value Range: 1 ~ 65535.
Tunnel Scenario	1. A Must filled setting 2. By default TUN is selected.	Specify the type of Tunnel Scenario for the OpenVPN Client to use. It can be TUN for TUN tunnel scenario, or TAP for TAP tunnel scenario.
Remote IP/FQDN	A Must filled setting	Specify the Remote IP/FQDN of the peer OpenVPN Server for this OpenVPN Client tunnel. Fill in the IP address or FQDN.
Remote Subnet	1. An Optional setting. 2. The box is unchecked by default.	Check the Enable box to activate remote subnet function, and specify Remote Subnet of the peer OpenVPN Server for this OpenVPN Client tunnel. Fill in the remote subnet address and remote subnet mask.
Redirect Internet Traffic	1. An Optional setting. 2. The box is unchecked by default.	Check the Enable box to activate the Redirect Internet Traffic function.
NAT	1. An Optional setting.	Check the Enable box to activate the NAT function.

4G Vehicle Gateway

	2. The box is checked by default.	
Authorization Mode	1. A Must filled setting 2. By default TLS is selected.	Specify the authorization mode for the OpenVPN Server. <ul style="list-style-type: none"> • TLS ->The OpenVPN will use TLS authorization mode, and the following items CA Cert., Client Cert. and Client Key will be displayed. CA Cert. could be selected in Trusted CA Certificate List. Refer to Object Definition > Certificate > Trusted Certificate. Client Cert. could be selected in Local Certificate List. Refer to Object Definition > Certificate > My Certificate. Client Key could be selected in Trusted Client key List. Refer to Object Definition > Certificate > Trusted Certificate. • Static Key ->The OpenVPN will use static key authorization mode, and the following items Local Endpoint IP Address, Remote Endpoint IP Address and Static Key will be displayed.
Local Endpoint IP Address	A Must filled setting	Specify the virtual Local Endpoint IP Address of this OpenVPN gateway. Value Range: The IP format is 10.8.0.x, the range of x is 1~254. Note: Local Endpoint IP Address will be available only when Static Key is chosen in Authorization Mode.
Remote Endpoint IP Address	A Must filled setting	Specify the virtual Remote Endpoint IP Address of the peer OpenVPN gateway. Value Range: The IP format is 10.8.0.x, the range of x is 1~254. Note: Remote Endpoint IP Address will be available only when Static Key is chosen in Authorization Mode.
Static Key	A Must filled setting	Specify the Static Key . Note: Static Key will be available only when Static Key is chosen in Authorization Mode.
Encryption Cipher	By default Blowfish is selected.	Specify the Encryption Cipher . It can be Blowfish/AES-256/AES-192/AES-128/None .
Hash Algorithm	By default SHA-1 is selected.	Specify the Hash Algorithm . It can be SHA-1/MD5/MD4/SHA2-256/SHA2-512/None/Disable .
LZO Compression	By default Adaptive is selected.	Specify the LZO Compression scheme. It can be Adaptive/YES/NO/Default .
Multicast	1. An Optional setting. 2. The box is checked by default.	Check the Enable box to activate the Multicast function. Note: Multicast function is only available for TAP tunnel scenario.
Persis Key	1. An Optional setting. 2. The box is checked by default.	Check the Enable box to activate the Persis Key function.
Persis Tun	1. An Optional setting. 2. The box is checked by default.	Check the Enable box to activate the Persis Tun function.
Advanced Configuration	N/A	Click the Edit button to specify the Advanced Configuration setting for the OpenVPN server. If the button is clicked, Advanced Configuration will be displayed below.
Tunnel	The box is unchecked by default	Check the Enable box to activate this OpenVPN tunnel.
Save	N/A	Click Save to save the settings.
Undo	N/A	Click X to cancel the changes and return to last page.

4G Vehicle Gateway

When **Advanced Configuration** is selected, an OpenVPN Client Advanced Configuration screen will appear.

OpenVPN Client Advanced Configuration	
Item	Setting
▶ TLS Cipher	None ▼
▶ TLS Auth. Key(Optional)	<input type="text"/> (Optional)
▶ User Name(Optional)	<input type="text"/> (Optional)
▶ Password(Optional)	<input type="text"/> (Optional)
▶ Bridge TAP to	VLAN 1 ▼
▶ Firewall Protection	<input type="checkbox"/> Enable
▶ Client IP Address	Dynamic IP ▼
▶ Tunnel MTU	1500
▶ Tunnel UDP Fragment	1500
▶ Tunnel UDP MSS-Fix	<input type="checkbox"/> Enable
▶ nsCertType Verification	<input type="checkbox"/> Enable
▶ TLS Renegotiation Time(seconds)	3600 (seconds)
▶ Connection Retry(seconds)	-1 (seconds)
▶ DNS	Automatically ▼
▶ Additional Configuration	<input type="text"/>

OpenVPN Advanced Client Configuration		
Item	Value setting	Description
TLS Cipher	1. A Must filled setting. 2. TLS-RSA-WITH-AES128-SHA is selected by default	Specify the TLS Cipher from the dropdown list. It can be None / TLS-RSA-WITH-RC4-MD5 / TLS-RSA-WITH-AES128-SHA / TLS-RSA-WITH-AES256-SHA / TLS-DHE-DSS-AES128-SHA / TLS-DHE-DSS-AES256-SHA . Note: TLS Cipher will be available only when TLS is chosen in Authorization Mode.
TLS Auth. Key	1. An Optional setting. 2. String format: any text	Specify the TLS Auth. Key for connecting to an OpenVPN server, if the server required it. Note: TLS Auth. Key will be available only when TLS is chosen in Authorization Mode.
User Name	An Optional setting.	Enter the User account for connecting to an OpenVPN server, if the server required it. Note: User Name will be available only when TLS is chosen in Authorization Mode.
Password	An Optional setting.	Enter the Password for connecting to an OpenVPN server, if the server required it. Note: User Name will be available only when TLS is chosen in Authorization Mode.
Bridge TAP to	By default VLAN 1 is selected	Specify the setting of “ Bridge TAP to ” to bridge the TAP interface to a certain local network interface or VLAN. Note: Bridge TAP to will be available only when TAP is chosen in Tunnel Scenario and NAT is unchecked.
Firewall Protection	The box is unchecked by default.	Check the box to activate the Firewall Protection function. Note: Firewall Protection will be available only when NAT is enabled.

4G Vehicle Gateway

Client IP Address	By default Dynamic IP is selected	Specify the virtual IP Address for the OpenVPN Client. It can be Dynamic IP/Static IP .
Tunnel MTU	1.A Must filled setting 2.The value is 1500 by default	Specify the value of Tunnel MTU . Value Range: 0 ~ 1500.
Tunnel UDP Fragment	The value is 1500 by default	Specify the value of Tunnel UDP Fragment . Value Range: 0 ~ 1500. Note: Tunnel UDP Fragment will be available only when UDP is chosen in Protocol.
Tunnel UDP MSS-Fix	The box is unchecked by default.	Check the Enable box to activate the Tunnel UDP MSS-Fix function. Note: Tunnel UDP MSS-Fix will be available only when UDP is chosen in Protocol.
nsCerType Verification	The box is unchecked by default.	Check the Enable box to activate the nsCerType Verification function. Note: nsCerType Verification will be available only when TLS is chosen in Authorization Mode.
TLS Renegotiation Time (seconds)	The value is 3600 by default	Specify the time interval of TLS Renegotiation Time . Value Range: -1 ~ 86400.
Connection Retry(seconds)	The value is -1 by default	Specify the time interval of Connection Retry . The default -1 means that it is no need to execute connection retry. Value Range: -1 ~ 86400, and -1 means no retry is required.
DNS	By default Automatically is selected	Specify the setting of DNS . It can be Automatically/Manually .
Additional Configuration	An Optional setting.	Enter optional configuration string here. Up to 256 characters is allowable. Value Range: 0 ~ 256 characters.
Save	N/A	Click Save to save the settings.
Undo	N/A	Click X to cancel the changes and return to last page.

4G Vehicle Gateway

5.1.3 L2TP

Configuration	
Item	Setting
L2TP	<input type="checkbox"/> Enable
Client/Server	Server ▾

L2TP Server Configuration	
Item	Setting
L2TP Server	<input type="checkbox"/> Enable
Interface	All WANs ▾
L2TP over IPsec	<input type="checkbox"/> Enable Preshared Key <input type="text"/> (Min. 8 characters)
Server Virtual IP	<input type="text" value="192.168.10.1"/>
IP Pool Starting Address	<input type="text" value="10"/>
IP Pool Ending Address	<input type="text" value="17"/>
Authentication Protocol	<input type="checkbox"/> PAP <input type="checkbox"/> CHAP <input type="checkbox"/> MS-CHAP <input type="checkbox"/> MS-CHAP v2
MPPE Encryption	<input type="checkbox"/> Enable <input type="text" value="40 bits"/> ▾
Service Port	<input type="text" value="1701"/>

L2TP Server Status <input type="button" value="Refresh"/>				
User Name	Remote IP	Remote Virtual IP	Remote Call ID	Actions
No connection from remote				

User Account List <input type="button" value="Add"/> <input type="button" value="Delete"/>				
ID	User Name	Password	Enable	Actions

Layer 2 Tunneling Protocol (L2TP) is a tunneling protocol used to support virtual private networks (VPNs) or as part of the delivery of services by ISPs. It does not provide any encryption or confidentiality by itself. Rather, it relies on an encryption protocol that it passes within the tunnel to provide privacy. This Gateway can behave as a L2TP server and a L2TP client both at the same time.

L2TP Server: It must have a static IP or a FQDN for clients to create L2TP tunnels. It also maintains “User Account list” (user name/ password) for client login authentication; There is a virtual IP pool to assign virtual IP to each connected L2TP client.

L2TP Client: It can be mobile users or gateways in remote offices with dynamic IP. To setup tunnel, it should get “user name”, “password” and server’s global IP. In addition, it is required to identify the operation mode for each tunnel as main connection, failover for another tunnel, or load balance tunnel to increase overall bandwidth. It needs to decide “Default Gateway” or “Remote Subnet” for packet flow. Moreover, you can also define what kind of traffics will pass through the L2TP tunnel in the “Default Gateway / Remote Subnet” parameter.

4G Vehicle Gateway

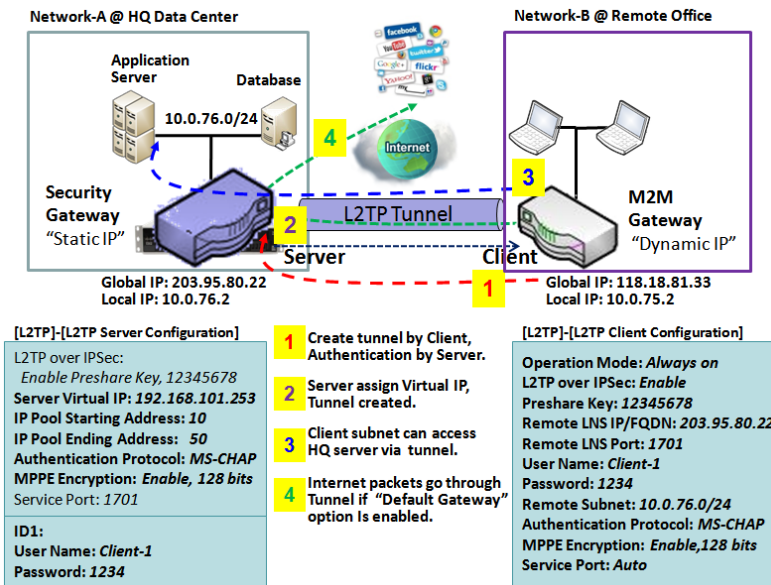

Besides, for the L2TP client peer, a Remote Subnet item is required. It is for the Intranet of L2TP server peer. So, at L2TP client peer, the packets whose destination is in the dedicated subnet will be transferred via the L2TP tunnel. Others will be transferred based on current routing policy of the gateway at L2TP client peer. But, if you entered 0.0.0.0/0 in the Remote Subnet field, it will be treated as a "Default Gateway" setting for the L2TP client peer, all packets, including the Internet accessing of L2TP client peer, will go through the established L2TP tunnel. That means the remote L2TP server peer controls the flow of any packets from the L2TP client peer. Certainly, those packets come through the L2TP tunnel.

4G Vehicle Gateway

L2TP Setting

Go to **Security > VPN > L2TP** tab.

The L2TP setting allows user to create and configure L2TP tunnels.

Enable L2TP

Configuration	
Item	Setting
L2TP	<input type="checkbox"/> Enable
Client/Server	Server ▾

Item	Value setting	Description
L2TP	Unchecked by default	Click the Enable box to activate L2TP function.
Client/Server	A Must filled setting	Specify the role of L2TP. Select Server or Client role your gateway will take. Below are the configuration windows for L2TP Server and for L2TP Client.
Save	N/A	Click Save button to save the settings

As a L2TP Server

When select **Server** in Client/Server, the L2TP server Configuration will appear.

L2TP Server Configuration	
Item	Setting
L2TP Server	<input type="checkbox"/> Enable
Interface	All WANs ▾
L2TP over IPsec	<input type="checkbox"/> Enable Preshared Key <input type="text"/> (Min. 2 characters)
Server Virtual IP	<input type="text" value="192.168.10.1"/>
IP Pool Starting Address	<input type="text" value="10"/>
IP Pool Ending Address	<input type="text" value="17"/>
Authentication Protocol	<input type="checkbox"/> PAP <input type="checkbox"/> CHAP <input type="checkbox"/> MS-CHAP <input type="checkbox"/> MS-CHAP v2
MPPE Encryption	<input type="checkbox"/> Enable <input type="text" value="40 bits"/> ▾
Service Port	<input type="text" value="1701"/>

L2TP Server Configuration

4G Vehicle Gateway

Item	Value setting	Description
L2TP Server	The box is unchecked by default	When click the Enable box It will active L2TP server
Interface	1. A Must fill setting 2. All WANs is selected by default	Select the interface on which L2TP tunnel is to be established. It can be the available WAN interfaces.
L2TP over IPsec	The box is unchecked by default	When click the Enable box. It will enable L2TP over IPsec and need to fill in the Pre-shared Key (2~31 characters).
Server Virtual IP	A Must filled setting	Specify the L2TP server Virtual IP It will set as this L2TP server local virtual IP
IP Pool Starting Address	1. A Must filled setting 2. 10 is set by default.	Specify the L2TP server starting IP of virtual IP pool It will set as the starting IP which assign to L2TP client Value Range: 1 ~ 254.
IP Pool Ending Address	1. A Must filled setting 2. 17 is set by default.	Specify the L2TP server ending IP of virtual IP pool It will set as the ending IP which assign to L2TP client Value Range: >= Starting Address, and < (Starting Address + 8) or 254.
Authentication Protocol	A Must filled setting	Select single or multiple Authentication Protocols for the L2TP server with which to authenticate L2TP clients. Available authentication protocols are PAP / CHAP / MS-CHAP / MS-CHAP v2.
MPPE Encryption	A Must filled setting	Specify whether to support MPPE Protocol. Click the Enable box to enable MPPE and from dropdown box to select 40 bits / 56 bits / 128 bits. Note: when MPPE Encryption is enabled, the Authentication Protocol PAP / CHAP options will not be available.
Service Port	A Must filled setting	Specify the Service Port which L2TP server use. Value Range: 1 ~ 65535.
Save	N/A	Click the Save button to save the configuration.
Undo	N/A	Click the Undo button to recovery the configuration.

L2TP Server Status Refresh				
User Name	Remote IP	Remote Virtual IP	Remote Call ID	Actions
No connection from remote				

L2TP Server Status		
Item	Value setting	Description
L2TP Server Status	N/A	It displays the User Name, Remote IP, Remote Virtual IP, and Remote Call ID of the connected L2TP clients. Click the Refresh button to renew the L2TP client information.

4G Vehicle Gateway

User Account List Add Delete				
ID	User Name	Password	Enable	Actions
User Account Configuration Save				
User Name		Password		Account
<input type="text"/>		<input type="text"/>		<input type="checkbox"/> Enable
Save				

User Account List Window		
Item	Value setting	Description
User Account List	Max.of 10 user accounts	<p>This is the L2TP authentication user account entry. You can create and add accounts for remote clients to establish L2TP VPN connection to the gateway device.</p> <p>Click Add button to add user account. Enter User name and password. Then check the enable box to enable the user.</p> <p>Click Save button to save new user account.</p> <p>The selected user account can permanently be deleted by clicking the Delete button.</p> <p><u>Value Range: 1 ~ 32 characters.</u></p>

4G Vehicle Gateway

As a L2TP Client

When select Client in Client/Server, a series L2TP Client Configuration will appear.

L2TP Client Configuration	
Item	Setting
L2TP Client	<input type="checkbox"/> Enable

Item	Setting	Value setting	Description
L2TP Client		The box is unchecked by default	Check the Enable box to enable L2TP client role of the gateway.
Save		N/A	Click Save button to save the settings.
Undo		N/A	Click Undo button to cancel the settings.

Create/Edit L2TP Client

L2TP Client List & Status								
ID	Tunnel Name	Interface	Virtual IP	Remote IP/FQDN	Remote Subnet	Status	Enable	Actions
1	L2TP #1	WAN 1	0.0.0.0	192.168.127.72			<input type="checkbox"/>	<input type="button" value="Edit"/> <input type="checkbox"/> Select

When **Add/Edit** button is applied, a series of configuration screen will appear. You can add up to 8 L2TP Clients.

L2TP Client Configuration	
Item	Setting
Tunnel Name	<input type="text" value="L2TP #1"/>
Interface	<input type="text" value="WAN-1"/>
L2TP over IPsec	<input type="checkbox"/> Enable Preshared Key <input type="text"/> (Min. 2 characters)
Remote LNS IP/FQDN	<input type="text"/>
MTU	<input type="text" value="1500"/>
Remote LNS Port	<input type="text" value="1701"/>
User Name	<input type="text"/>
Password	<input type="text"/>
Tunneling Password (Optional)	<input type="text"/>
Remote Subnet	<input type="text"/>
Authentication Protocol	<input type="checkbox"/> PAP <input type="checkbox"/> CHAP <input type="checkbox"/> MS-CHAP <input type="checkbox"/> MS-CHAP v2

4G Vehicle Gateway

▶ MPPE Encryption	<input type="checkbox"/> Enable
▶ NAT before Tunneling	<input type="checkbox"/> Enable
▶ LCP Echo Type	<input type="text" value="Auto"/> Interval <input type="text" value="30"/> seconds Max. Failure Time <input type="text" value="6"/> times
▶ Service Port	<input type="text" value="Auto"/> <input type="text" value="0"/>
▶ Tunnel	<input type="checkbox"/> Enable

L2TP Client Configuration		
Item Setting	Value setting	Description
Tunnel Name	A Must filled setting	Enter a tunnel name. Enter a name that is easy for you to identify. Value Range: 1 ~ 32 characters.
Interface	A Must filled setting	Define the selected interface to be the used for this L2TP tunnel (WAN-1 is available only when WAN-1 interface is enabled) The same applies to other WAN interfaces (e.g. WAN-2).
L2TP over IPsec	The box is unchecked by default	When click the Enable box. It will enable L2TP over IPsec and need to fill in the Pre-shared Key (2~31 characters).
Remote LNS IP/FQDN	A Must filled setting	Enter the public IP address or the FQDN of the L2TP server.
MTU	1.A Must filled setting 2.The value is 1500 by default	Specify the MTU . Value Range: 0 ~ 1500.
Remote LNS Port	1. A Must filled setting 2. 1701 is set by default	Enter the Remote LNS Port for this L2TP tunnel. Value Range: 1 ~ 65535.
User Name	A Must filled setting	Enter the User Name for this L2TP tunnel to be authenticated when connect to L2TP server. Value Range: 1 ~ 32 characters.
Password	A Must filled setting	Enter the Password for this L2TP tunnel to be authenticated when connect to L2TP server.
Tunneling Password(Optional)	An Optional filled setting	Enter the Tunneling Password for this L2TP tunnel to authenticate.
Remote Subnet	A Must filled setting	Specify the remote subnet for this L2TP tunnel to reach L2TP server. The Remote Subnet format must be IP address/netmask (e.g. 10.0.0.2/24). It is for the Intranet of L2TP VPN server. So, at L2TP client peer, the packets whose destination is in the dedicated subnet will be transferred via the L2TP VPN tunnel. Others will be transferred based on current routing policy of the security gateway at L2TP client peer. If you entered 0.0.0.0/0 in the Remote Subnet field, it will be treated as a default gateway setting for the L2TP client peer, all packets, including the Internet accessing of L2TP Client peer, will go through the established L2TP VPN tunnel. That means the remote L2TP VPN server controls the flow of any packets from the L2TP client peer. Certainly, those packets come through the L2TP VPN tunnel.
Authentication Protocol	1. A Must filled setting 2. Unchecked by	Specify one ore multiple Authentication Protocol for this L2TP tunnel. Available authentication methods are PAP / CHAP / MS-CHAP / MS-CHAP v2 .

4G Vehicle Gateway

	default	
MPPE Encryption	<ol style="list-style-type: none"> 1. Unchecked by default 2. an optional setting 	<p>Specify whether L2TP server supports MPPE Protocol. Click the Enable box to enable MPPE.</p> <p>Note: when MPPE Encryption is enabled, the Authentication Protocol PAP / CHAP options will not be available.</p>
NAT before Tunneling	<ol style="list-style-type: none"> 1. A Must filled setting 2. Unchecked by default 	Specify whether NAT is required or not for this L2TP tunnel.
LCP Echo Type	<ol style="list-style-type: none"> 1. Auto is set by default 	<p>Specify the LCP Echo Type for this L2TP tunnel. It can be Auto, User-defined, or Disable.</p> <p>Auto: the system sets the Interval and Max. Failure Time.</p> <p>User-defined: enter the Interval and Max. Failure Time. The default value for Interval is 30 seconds, and Maximum Failure Times is 6 Times.</p> <p>Disable: disable the LCP Echo.</p> <p>Value Range: 1 ~ 99999 for Interval Time, 1~999 for Failure Time.</p>
Service Port	A Must filled setting	<p>Specify the Service Port for this L2TP tunnel to use. It can be Auto, (1701) for Cisco, or User-defined.</p> <p>Auto: The system determines the service port.</p> <p>1701 (for Cisco): The system use port 1701 for connecting with CISCO L2TP Server.</p> <p>User-defined: Enter the service port. The default value is 0.</p> <p>Value Range: 0 ~ 65535.</p>
Tunnel	Unchecked by default	Check the Enable box to enable this L2TP tunnel.
Save	N/A	Click Save button to save the settings.
Undo	N/A	Click X button to cancel the settings and back to last page.

4G Vehicle Gateway

5.1.4 PPTP

Configuration	
Item	Setting
PPTP	<input type="checkbox"/> Enable
Client/Server	Server ▾

PPTP Server Configuration	
Item	Setting
PPTP Server	<input type="checkbox"/> Enable
Interface	All WANs ▾
Server Virtual IP	192.168.0.1
IP Pool Starting Address	10
IP Pool Ending Address	17
Authentication Protocol	<input type="checkbox"/> PAP <input type="checkbox"/> CHAP <input type="checkbox"/> MS-CHAP <input type="checkbox"/> MS-CHAP v2
MPPE Encryption	<input type="checkbox"/> Enable 40 bits ▾

PPTP Server Status Refresh				
User Name	Remote IP	Remote Virtual IP	Remote Call ID	Actions
No connection from remote				

User Account List Add Delete				
ID	User Name	Password	Enable	Actions

Point-to-Point Tunneling Protocol (PPTP) is a method for implementing virtual private networks. PPTP uses a control channel over TCP and a GRE tunnel operating to encapsulate PPP packets. It is a client-server based technology. There are various levels of authentication and encryption for PPTP tunneling, usually natively as standard features of the Windows PPTP stack. The security gateway can play either "PPTP Server" role or "PPTP Client" role for a PPTP VPN tunnel, or both at the same time for different tunnels. PPTP tunnel process is nearly the same as L2TP.

PPTP Server: It must have a static IP or a FQDN for clients to create PPTP tunnels. It also maintains "User Account list" (user name / password) for client login authentication; There is a virtual IP pool to assign virtual IP to each connected PPTP client. u

PPTP Client: It can be mobile users or gateways in remote offices with dynamic IP. To setup tunnel, it should get "user name", "password" and server's global IP. In addition, it is required to identify the operation mode for each tunnel as main connection, failover for another tunnel, or load balance tunnel to increase overall bandwidth. It needs to decide "Default Gateway" or "Remote Subnet" for packet flow. Moreover, you can also define what kind of traffics will pass through the PPTP tunnel in the "Default Gateway / Remote Subnet" parameter.

4G Vehicle Gateway

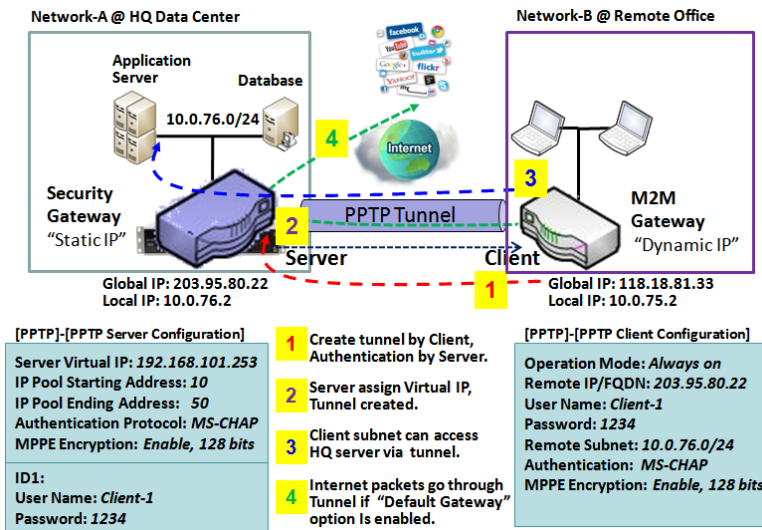

Besides, for the PPTP client peer, a Remote Subnet item is required. It is for the Intranet of PPTP server peer. So, at PPTP client peer, the packets whose destination is in the dedicated subnet will be transferred via the PPTP tunnel. Others will be transferred based on current routing policy of the gateway at PPTP client peer. But, if you entered 0.0.0.0/0 in the Remote Subnet field, it will be treated as a "Default Gateway" setting for the PPTP client peer, all packets, including the Internet accessing of PPTP client peer, will go through the established PPTP tunnel. That means the remote PPTP server peer controls the flow of any packets from the PPTP client peer.

Certainly, those packets come through the PPTP tunnel.

4G Vehicle Gateway

PPTP Setting

Go to **Security > VPN > PPTP** tab.

The PPTP setting allows user to create and configure PPTP tunnels.

Enable PPTP

Configuration	
Item	Setting
PPTP	<input type="checkbox"/> Enable
Client/Server	Server ▾

Enable PPTP Window		
Item	Value setting	Description
PPTP	Unchecked by default	Click the Enable box to activate PPTP function.
Client/Server	A Must fill setting	Specify the role of PPTP. Select Server or Client role your gateway will take. Below are the configuration windows for PPTP Server and for Client.
Save	N/A	Click Save button to save the settings.

As a PPTP Server

The gateway supports up to a maximum of 10 PPTP user accounts.

When **Server** in the Client/Server field is selected, the PPTP server configuration window will appear.

PPTP Server Configuration	
Item	Setting
PPTP Server	<input type="checkbox"/> Enable
Interface	WAN1 ▾
Server Virtual IP	192.168.12.1
IP Pool Starting Address	10
IP Pool Ending Address	17
Authentication Protocol	<input type="checkbox"/> PAP <input type="checkbox"/> CHAP <input checked="" type="checkbox"/> MS-CHAP <input checked="" type="checkbox"/> MS-CHAP v2
MPPE Encryption	<input checked="" type="checkbox"/> Enable 40 bits ▾

4G Vehicle Gateway

PPTP Server Configuration Window		
Item	Value setting	Description
PPTP Server	Unchecked by default	Check the Enable box to enable PPTP server role of the gateway.
Interface	1. A Must fill setting 2. All WANs is selected by default	Select the interface on which PPTP tunnel is to be established. It can be the available WAN interfaces.
Server Virtual IP	1. A Must fill setting 2. Default is 192.168.0.1	Specify the PPTP server Virtual IP address. The virtual IP address will serve as the virtual DHCP server for the PPTP clients. Clients will be assigned a virtual IP address from it after the PPTP tunnel has been established.
IP Pool Starting Address	1. A Must fill setting 2. Default is 10	This is the PPTP server's Virtual IP DHCP server. User can specify the first IP address for the subnet from which the PPTP client's IP address will be assigned. Value Range: 1 ~ 254.
IP Pool Ending Address	1. A Must fill setting 2. Default is 17	This is the PPTP server's Virtual IP DHCP server. User can specify the last IP address for the subnet from which the PPTP client's IP address will be assigned. Value Range: >= Starting Address, and < (Starting Address + 8) or 254.
Authentication Protocol	1. A Must fill setting 2. Unchecked by default	Select single or multiple Authentication Protocols for the PPTP server with which to authenticate PPTP clients. Available authentication protocols are PAP / CHAP / MS-CHAP / MS-CHAP v2.
MPPE Encryption	1. A Must fill setting 2. Unchecked by default	Specify whether to support MPPE Protocol. Click the Enable box to enable MPPE and from dropdown box to select 40 bits / 56 bits / 128 bits. Note: when MPPE Encryption is enabled, the Authentication Protocol PAP / CHAP options will not be available.
Save	N/A	Click Save button to save the settings.
Undo	N/A	Click Undo button to cancel the settings.

PPTP Server Status Refresh				
User Name	Remote IP	Remote Virtual IP	Remote Call ID	Actions
No connection from remote				

PPTP Server Status Window		
Item	Value setting	Description
PPTP Server Status	N/A	It displays the User Name, Remote IP, Remote Virtual IP, and Remote Call ID of the connected PPTP clients. Click the Refresh button to renew the PPTP client information.

User Account List Add Delete				
ID	User Name	Password	Enable	Actions
User Account Configuration Refresh				
User Name		Password		Account
<input type="text"/>		<input type="text"/>		<input type="checkbox"/> Enable
Save				

User Account List Window		
Item	Value setting	Description

4G Vehicle Gateway

<p>User Account List</p>	<p>Max.of 10 user accounts</p>	<p>This is the PPTP authentication user account entry. You can create and add accounts for remote clients to establish PPTP VPN connection to the gateway device.</p> <p>Click Add button to add user account. Enter User name and password. Then check the enable box to enable the user.</p> <p>Click Save button to save new user account.</p> <p>The selected user account can permanently be deleted by clicking the Delete button.</p> <p>Value Range: 1 ~ 32 characters.</p>
---------------------------------	--------------------------------	--

As a PPTP Client

When select Client in Client/Server, a series PPTP Client Configuration will appear.

PPTP Client Configuration	
Item	Setting
PPTP Client	<input type="checkbox"/> Enable

PPTP Client Configuration		
Item	Value setting	Description
PPTP Client	Unchecked by default	Check the Enable box to enable PPTP client role of the gateway.
Save	N/A	Click Save button to save the settings.
Undo	N/A	Click Undo button to cancel the settings.

Create/Edit PPTP Client

PPTP Client List & Status								
ID	Tunnel Name	Interface	Virtual IP	Remote IP/FQDN	Remote Subnet	Status	Enable	Actions

When **Add/Edit** button is applied, a series PPTP Client Configuration will appear.

4G Vehicle Gateway

PPTP Client Configuration	
Item	Setting
▶ Tunnel Name	<input type="text" value="PPTP #1"/>
▶ Interface	<input type="text" value="WAN1"/>
▶ Remote IP/FQDN	<input type="text"/>
▶ MTU	<input type="text" value="1500"/>
▶ User Name	<input type="text"/>
▶ Password	<input type="text"/>
▶ Remote Subnet	<input type="text"/>
▶ Authentication Protocol	<input type="checkbox"/> PAP <input type="checkbox"/> CHAP <input type="checkbox"/> MS-CHAP <input type="checkbox"/> MS-CHAP v2
▶ MPPE Encryption	<input type="checkbox"/> Enable
▶ NAT before Tunneling	<input type="checkbox"/> Enable
▶ LCP Echo Type	<input type="text" value="Auto"/>
	Interval <input type="text" value="30"/> seconds Max. Failure Time <input type="text" value="6"/> times
▶ Tunnel	<input type="checkbox"/> Enable

PPTP Client Configuration Window		
Item	Value setting	Description
Tunnel Name	A Must fill setting	Enter a tunnel name. Enter a name that is easy for you to identify. Value Range: 1 ~ 32 characters.
Interface	1. A Must fill setting 2. WAN1 is selected by default	Define the selected interface to be the used for this PPTP tunnel (WAN-1 is available only when WAN-1 interface is enabled) The same applies to other WAN interfaces (e.g. WAN-2).
Remote IP/FQDN	1. A Must fill setting. 2. Format can be a ipv4 address or FQDN	Enter the public IP address or the FQDN of the PPTP server.
MTU	1.A Must filled setting 2.The value is 1500 by default	Specify the MTU . Value Range: 0 ~ 1500.
User Name	A Must fill setting	Enter the User Name for this PPTP tunnel to be authenticated when connect to PPTP server. Value Range: 1 ~ 32 characters.
Password	A Must fill setting	Enter the Password for this PPTP tunnel to be authenticated when connect to PPTP server.
Remote Subnet	A Must fill setting	Specify the remote subnet for this PPTP tunnel to reach PPTP server. The Remote Subnet format must be IP address/netmask (e.g. 10.0.0.2/24). It is for the Intranet of PPTP VPN server. So, at PPTP client peer, the packets whose destination is in the dedicated subnet will be transferred via the PPTP VPN tunnel. Others will be transferred based on current routing policy of the security gateway at PPTP client peer. If you entered 0.0.0.0/0 in the Remote Subnet field, it will be treated as a default gateway setting for the PPTP client peer, all packets, including the Internet accessing of PPTP Client peer, will go through the established PPTP VPN tunnel. That means the remote PPTP VPN server controls the flow of any

4G Vehicle Gateway

		packets from the PPTP client peer. Certainly, those packets come through the PPTP VPN tunnel.
Authentication Protocol	1. A Must fill setting 2. Unchecked by default	Specify one ore multiple Authentication Protocol for this PPTP tunnel. Available authentication methods are PAP / CHAP / MS-CHAP / MS-CHAP v2 .
MPPE Encryption	1. Unchecked by default 2. an optional setting	Specify whether PPTP server supports MPPE Protocol . Click the Enable box to enable MPPE. Note: when MPPE Encryption is enabled, the Authentication Protocol PAP / CHAP options will not be available.
NAT before Tunneling	1. A Must filled setting 2. Unchecked by default	Specify whether NAT is required or not for this PPTP tunnel.
LCP Echo Type	Auto is set by default	Specify the LCP Echo Type for this PPTP tunnel. It can be Auto , User-defined , or Disable . Auto : the system sets the Interval and Max. Failure Time. User-defined : enter the Interval and Max. Failure Time. The default value for Interval is 30 seconds, and Maximum Failure Times is 6 Times. Disable : disable the LCP Echo. Value Range : 1 ~ 99999 for Interval Time, 1~999 for Failure Time.
Tunnel	Unchecked by default	Check the Enable box to enable this PPTP tunnel.
Save	N/A	Click Save button to save the settings.
Undo	N/A	Click X button to cancel the settings and back to last page.

4G Vehicle Gateway

5.1.5 GRE

Configuration									
Item	Setting								
GRE Tunnel	<input type="checkbox"/> Enable								
Max. Concurrent GRE Tunnels	32								

GRE Tunnel List										
ID	Tunnel Name	Interface	Tunnel IP	Remote IP	MTU	Key	TTL	Remote Subnet	Enable	Actions
<input type="button" value="Add"/> <input type="button" value="Delete"/>										

Generic Routing Encapsulation (GRE) is a tunneling protocol developed by Cisco Systems that encapsulates a wide variety of network layer protocols inside virtual point-to-point links over an Internet Protocol internetwork.

Deploy a M2M gateway for remote site and establish a virtual private network with control center by using GRE tunneling. So, all client hosts behind M2M gateway can make data communication with server hosts behind control center gateway.

GRE Tunneling is similar to IPSec Tunneling, client requesting the tunnel establishment with the server. Both the client and the server must have a Static IP or a FQDN. Any peer gateway can be worked as either a client or a server, even using the same set of configuration rule.

GRE Tunnel Scenario

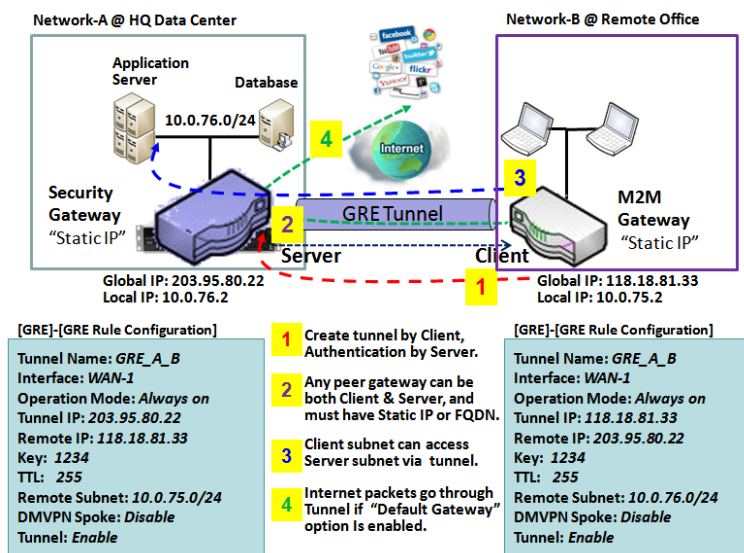

To setup a GRE tunnel, each peer needs to setup its global IP as tunnel IP and fill in the other's global IP as remote IP.

Besides, each peer must further specify the Remote Subnet item. It is for the Intranet of GRE server peer. So, at GRE client peer, the packets whose destination is in the dedicated subnet will be transferred via the GRE tunnel. Others will be transferred based on current routing policy of the gateway at GRE client peer. But, if you entered 0.0.0.0/0 in the Remote Subnet field, it will be treated as a "Default Gateway" setting for the GRE client peer, all packets, including the Internet accessing of GRE client peer, will go through the established GRE

tunnel. That means the remote GRE server peer controls the flow of any packets from the GRE client peer. Certainly, those packets come through the GRE tunnel.

If the GRE server supports DMVPN Hub function, like Cisco router as the VPN concentrator, the GRE client can active the DMVPN spoke function here since it is implemented by GRE over IPSec tunneling.

4G Vehicle Gateway

4G Vehicle Gateway

GRE Setting

Go to **Security > VPN > GRE** tab.

The GRE setting allows user to create and configure GRE tunnels.

Enable GRE

Configuration	
Item	Setting
GRE Tunnel	<input type="checkbox"/> Enable
Max. Concurrent GRE Tunnels	32

Enable GRE Window		
Item	Value setting	Description
GRE Tunnel	Unchecked by default	Click the Enable box to enable GRE function.
Max. Concurrent GRE Tunnels	Depends on Product specification.	The specified value will limit the maximum number of simultaneous GRE tunnel connection. The default value can be different for the purchased model.
Save	N/A	Click Save button to save the settings
Undo	N/A	Click Undo button to cancel the settings

Create/Edit GRE tunnel

GRE Tunnel List										
ID	Tunnel Name	Interface	Tunnel IP	Remote IP	MTU	Key	TTL	Remote Subnet	Enable	Actions

When **Add/Edit** button is applied, a GRE Rule Configuration screen will appear.

4G Vehicle Gateway

GRE Rule Configuration	
Item	Setting
▶ Tunnel Name	GRE #1
▶ Interface	WAN1 ▼
▶ Tunnel IP	IP: <input type="text"/> MASK: -- select one -- ▼ (Optional)
▶ Remote IP	<input type="text"/>
▶ MTU	<input type="text"/>
▶ Key	<input type="text"/> (Optional)
▶ TTL	<input type="text"/>
▶ Remote Subnet	<input type="text"/>
▶ Tunnel	<input type="checkbox"/> Enable

GRE Rule Configuration Window		
Item	Value setting	Description
Tunnel Name	A Must fill setting	Enter a tunnel name. Enter a name that is easy for you to identify. Value Range: 1 ~ 9 characters.
Interface	1. A Must fill setting 2. WAN 1 is selected by default	Select the interface on which GRE tunnel is to be established. It can be the available WAN and LAN interfaces.
Tunnel IP	An Optional setting	Enter the Tunnel IP address and corresponding subnet mask.
Remote IP	A Must fill setting	Enter the Remote IP address of remote GRE tunnel gateway. Normally this is the public IP address of the remote GRE gateway.
MTU	1. A Must filled setting 2. Auto (value zero or blank) is set by default	MTU refers to Maximum Transmission Unit. It specifies the largest packet size permitted for Internet transmission. When set to Auto (value '0' or blank), the router selects the best MTU for best Internet connection performance. Value Range: 0 ~ 1500.
Key	An Optional setting	Enter the Key for the GRE connection. Value Range: 0 ~ 9999999999.
TTL	1. A Must fill setting 2. 1 to 255 range	Specify TTL hop-count value for this GRE tunnel. Value Range: 1 ~ 255.
Remote Subnet	A Must fill setting	Specify the remote subnet for this GRE tunnel. The Remote Subnet format must be IP address/netmask (e.g. 10.0.0.2/24). It is for the Intranet of GRE server peer. So, at GRE client peer, the packets whose destination is in the dedicated subnet will be transferred via the GRE tunnel. Others will be transferred based on current routing policy of the security gateway at GRE client peer. If you entered 0.0.0.0/0 in the Remote Subnet field, it will be treated as a default gateway setting for the GRE client peer, all packets, including the

4G Vehicle Gateway

		Internet accessing of GRE client peer, will go through the established GRE tunnel. That means the remote GRE server peer controls the flow of any packets from the GRE client peer. Certainly, those packets come through the GRE tunnel.
Tunnel	Unchecked by default	Check Enable box to enable this GRE tunnel.
Save	N/A	Click Save button to save the settings.
Undo	N/A	Click X button to cancel the settings and back to last page.

4G Vehicle Gateway

5.2 Firewall

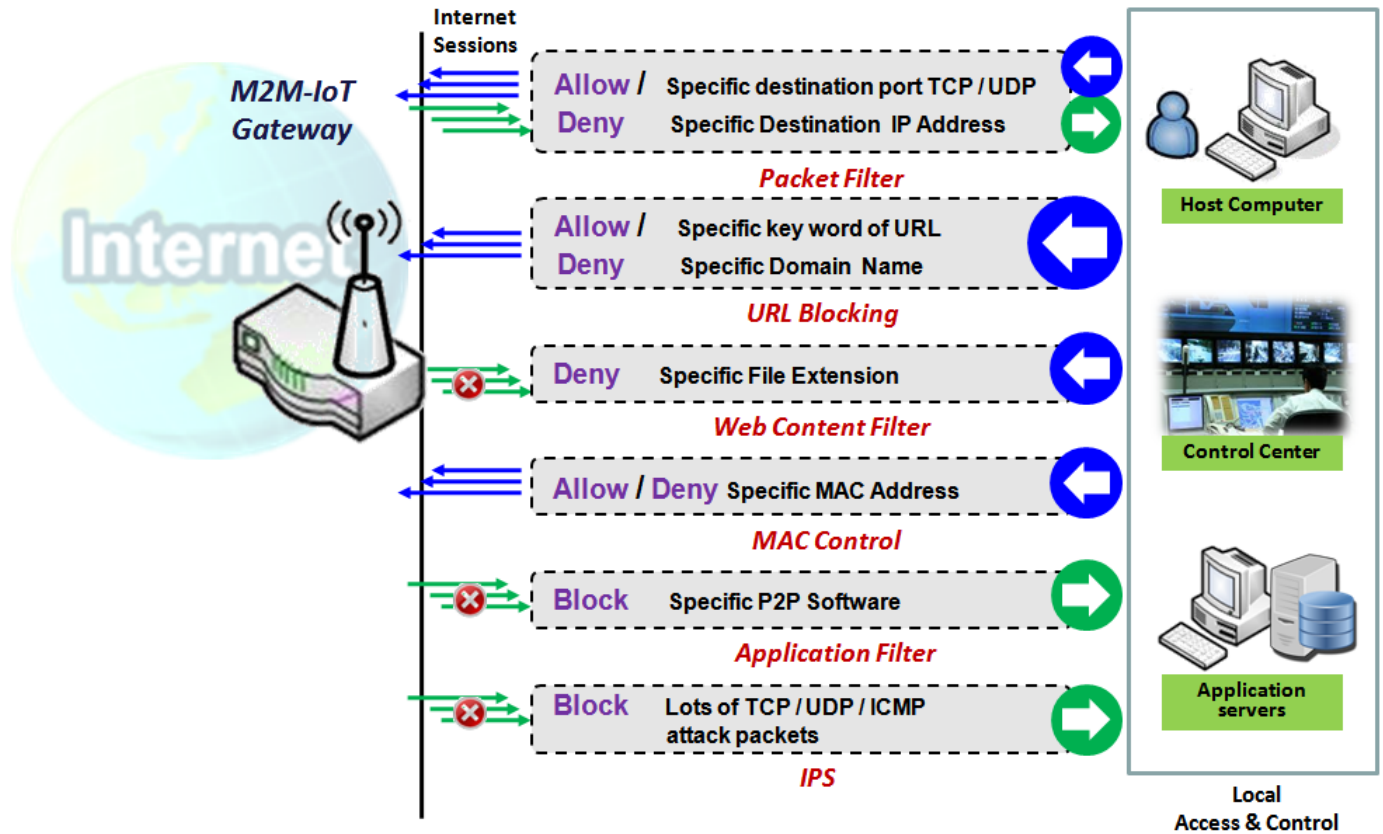

The firewall functions include Packet Filter, URL Blocking, Content Filter, MAC Control, Application Filter, IPS and some firewall options. The supported function can be different for the purchased gateway.

5.2.1 Packet Filter

Configuration												
Item	Setting											
Packet Filters	<input checked="" type="checkbox"/> Enable											
Black List / White List	Deny those match the following rules. ▾											
Log Alert	<input type="checkbox"/> Log Alert											
Packet Filter List												
ID	Rule Name	From Interface	To Interface	Source IP	Destination IP	Source MAC	Protocol	Source Port	Destination Port	Time Schedule	Enable	Actions

4G Vehicle Gateway

"Packet Filter" function can let you define some filtering rules for incoming and outgoing packets. So the gateway can control what packets are allowed or blocked to pass through it. A packet filter rule should indicate from and to which interface the packet enters and leaves the gateway, the source and destination IP addresses, and destination service port type and port number. In addition, the time schedule to which the rule will be active.

Packet Filter with White List Scenario

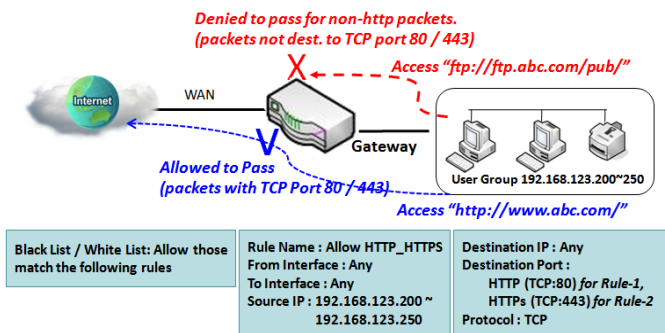

As shown in the diagram, specify "Packet Filter Rule List" as white list (Allow those match the following rules) and define the rules. Rule-1 is to allow HTTP packets to pass, and Rule-2 is to allow HTTPS packets to pass.

Under such configuration, the gateway will allow only HTTP and HTTPS packets, issued from the IP range 192.168.123.200 to 250, which are targeted to TCP port 80 or 443 to pass the WAN interface.

Packet Filter Setting

Go to **Security > Firewall > Packet Filter** Tab.

The packet filter setting allows user to create and customize packet filter policies to allow or reject specific inbound/outbound packets through the router based on their office setting.

Enable Packet Filter

Item	Setting
Packet Filters	<input type="checkbox"/> Enable
Black List / White List	Deny those match the following rules. ▾
Log Alert	<input type="checkbox"/> Log Alert

Item Name	Value setting	Description
Packet Filter	The box is unchecked by default	Check the Enable box to activate Packet Filter function

4G Vehicle Gateway

Black List / White List	Deny those match the following rules is set by default	When Deny those match the following rules is selected, as the name suggest, packets specified in the rules will be blocked –black listed. In contrast, with Allow those match the following rules , you can specifically white list the packets to pass and the rest will be blocked.
Log Alert	The box is unchecked by default	Check the Enable box to activate Event Log.
Save	N/A	Click Save to save the settings
Undo	N/A	Click Undo to cancel the settings

Create/Edit Packet Filter Rules

The gateway allows you to customize your packet filtering rules. It supports up to a maximum of 20 filter rule sets.

Packet Filter List
Add
Delete
▲
✕

ID	Rule Name	From Interface	To Interface	Source IP	Destination IP	Source MAC	Protocol	Source Port	Destination Port	Time Schedule	Enable	Actions
----	-----------	----------------	--------------	-----------	----------------	------------	----------	-------------	------------------	---------------	--------	---------

When **Add** button is applied, **Packet Filter Rule Configuration** screen will appear.

Packet Filter Rule Configuration

Item	Setting
▶ Rule Name	<input style="width: 90%;" type="text" value="Rule1"/>
▶ From Interface	<input style="border-bottom: 1px solid #ccc;" type="text" value="Any"/>
▶ To Interface	<input style="border-bottom: 1px solid #ccc;" type="text" value="Any"/>
▶ Source IP	<input style="border-bottom: 1px solid #ccc;" type="text" value="Any"/>
▶ Destination IP	<input style="border-bottom: 1px solid #ccc;" type="text" value="Any"/>
▶ Source MAC	<input style="border-bottom: 1px solid #ccc;" type="text" value="Any"/>
▶ Protocol	<input style="width: 90%;" type="text" value="Any(0)"/>
▶ Source Port	<input style="width: 45%;" type="text" value="User-defined Service"/> - <input style="width: 45%;" type="text"/>
▶ Destination Port	<input style="width: 45%;" type="text" value="User-defined Service"/> - <input style="width: 45%;" type="text"/>
▶ Time Schedule	<input style="width: 90%;" type="text" value="(0) Always"/>
▶ Rule	<input type="checkbox"/> Enable

Item Name	Value setting	Description
Rule Name	1. String format can be any text 2. A Must filled setting	Enter a packet filter rule name. Enter a name that is easy for you to remember. Value Range: 1 ~ 30 characters.
From Interface	1. A Must filled setting	Define the selected interface to be the packet-entering interface of the router.

4G Vehicle Gateway

	<p>2. By default Any is selected</p> <p>If the packets to be filtered are coming from LAN to WAN then select LAN for this field. Or VLAN-1 to WAN then select VLAN-1 for this field. Other examples are VLAN-1 to VLAN-2. VLAN-1 to WAN.</p> <p>Select Any to filter packets coming into the router from any interfaces.</p> <p>Please note that two identical interfaces are not accepted by the router. e.g., VLAN-1 to VLAN-1.</p>
<p>To Interface</p> <p>1. A Must filled setting 2. By default Any is selected</p>	<p>Define the selected interface to be the packet-leaving interface of the router. If the packets to be filtered are entering from LAN to WAN then select WAN for this field. Or VLAN-1 to WAN then select WAN for this field. Other examples are VLAN-1 to VLAN-2. VLAN-1 to WAN.</p> <p>Select Any to filter packets leaving the router from any interfaces.</p> <p>Please note that two identical interfaces are not accepted by the router. e.g., VLAN-1 to VLAN-1.</p>
<p>Source IP</p> <p>1. A Must filled setting 2. By default Any is selected</p>	<p>This field is to specify the Source IP address.</p> <p>Select Any to filter packets coming from any IP addresses.</p> <p>Select Specific IP Address to filter packets coming from an IP address.</p> <p>Select IP Range to filter packets coming from a specified range of IP address.</p> <p>Select IP Address-based Group to filter packets coming from a pre-defined group. Note: group must be pre-defined before this option become available. Refer to Object Definition > Grouping > Host grouping. You may also access to create a group by the Add Rule shortcut button.</p>
<p>Destination IP</p> <p>1. A Must filled setting 2. By default Any is selected</p>	<p>This field is to specify the Destination IP address.</p> <p>Select Any to filter packets that are entering to any IP addresses.</p> <p>Select Specific IP Address to filter packets entering to an IP address entered in this field.</p> <p>Select IP Range to filter packets entering to a specified range of IP address entered in this field.</p> <p>Select IP Address-based Group to filter packets entering to a pre-defined group selected. Note: group must be pre-defined before this selection become available. Refer to Object Definition > Grouping > Host grouping. You may also access to create a group by the Add Rule shortcut button. Setting done through the Add Rule button will also appear in the Host grouping setting screen.</p>
<p>Source MAC</p> <p>1. A Must filled setting 2. By default Any is selected</p>	<p>This field is to specify the Source MAC address.</p> <p>Select Any to filter packets coming from any MAC addresses.</p> <p>Select Specific MAC Address to filter packets coming from a MAC address.</p> <p>Select MAC Address-based Group to filter packets coming from a pre-defined group selected. Note: group must be pre-defined before this selection become available. Refer to Object Definition > Grouping > Host grouping. You may also access to create a group by the Add Rule shortcut button.</p>
<p>Protocol</p> <p>1. A Must filled setting 2. By default Any(0) is selected</p>	<p>For Protocol, select Any to filter any protocol packets</p> <p>Then for Source Port, select a predefined port dropdown box when Well-known Service is selected, otherwise select User-defined Service and specify a port range.</p> <p>Then for Destination Port, select a predefined port dropdown box when Well-known Service is selected, otherwise select User-defined Service and specify a port range.</p>

4G Vehicle Gateway

		<p>Value Range: 1 ~ 65535 for Source Port, Destination Port.</p> <p>For Protocol, select ICMPv4 to filter ICMPv4 packets</p> <p>For Protocol, select TCP to filter TCP packets</p> <p>Then for Source Port, select a predefined port dropdown box when Well-known Service is selected, otherwise select User-defined Service and specify a port range.</p> <p>Then for Destination Port, select a predefined port dropdown box when Well-known Service is selected, otherwise select User-defined Service and specify a port range.</p> <p>Value Range: 1 ~ 65535 for Source Port, Destination Port.</p> <p>For Protocol, select UDP to filter UDP packets</p> <p>Then for Source Port, select a predefined port dropdown box when Well-known Service is selected, otherwise select User-defined Service and specify a port range.</p> <p>Then for Destination Port, select a predefined port dropdown box when Well-known Service is selected, otherwise select User-defined Service and specify a port range.</p> <p>Value Range: 1 ~ 65535 for Source Port, Destination Port.</p> <p>For Protocol, select GRE to filter GRE packets</p> <p>For Protocol, select ESP to filter ESP packets</p> <p>For Protocol, select SCTP to filter SCTP packets</p> <p>For Protocol, select User-defined to filter packets with specified port number. Then enter a port number in Protocol Number box.</p>
Time Schedule	A Must filled setting	<p>Apply Time Schedule to this rule, otherwise leave it as Always.</p> <p>If the dropdown list is empty ensure Time Schedule is pre-configured. Refer to Object Definition > Scheduling > Configuration tab.</p>
Rule	The box is unchecked by default.	Click Enable box to activate this rule then save the settings.
Save	N/A	Click Save to save the settings.
Undo	N/A	Click X to cancel the settings and back to last page.

4G Vehicle Gateway

5.2.2 URL Blocking

"URL Blocking" function can let you define blocking or allowing rules for incoming and outgoing Web request packets. With defined rules, gateway can control the Web requests containing the complete URL, partial domain name, or pre-defined keywords. For example, one can filter out or allow only the Web requests based on domain input suffixes like .com or .org or keywords like "bct" or "mpe".

An URL blocking rule should specify the URL, partial domain name, or included keywords in the Web requests from and to the gateway and also the destination service port. Besides, a certain time schedule can be applied to activate the URL Blocking rules during pre-defined time interval(s).

The gateway will logs and displays the disallowed web accessing requests that matched the defined URL blocking rule in the black-list or in the exclusion of the white-list.

When you choose "Allow all to pass except those match the following rules" for the "URL Blocking Rule List", you are setting the defined URL blocking rules to belong to the black list. The packets, listed in the rule list, will be blocked if one pattern in the requests matches to one rule. Other Web requests can pass through the gateway. In contrast, when you choose "Deny all to pass except those match the following rules" for the "URL Blocking Rule List", you are setting the defined packet filtering rules to belong to the white list. The Web requests, listed in the rule, will be allowed if one pattern in the requests matches to one rule. Other Web requests will be blocked.

URL Blocking Rule with Black List

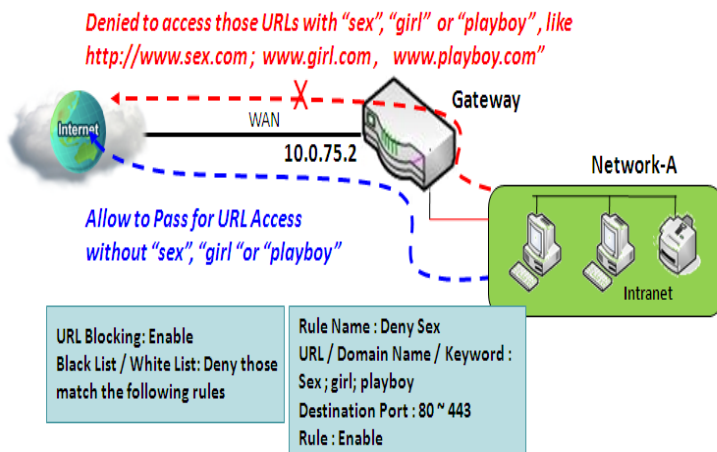

When the administrator of the gateway wants to block the Web requests with some dedicated patterns, he can use the "URL Blocking" function to block specific Web requests by defining the black list as shown in above diagram. Certainly, when the administrator wants to allow only the Web requests with some dedicated patterns to go through the gateway, he can also use the "URL Blocking" function by defining the white list to meet the requirement.

As shown in the diagram, enable the URL blocking function and create the first rule to deny the Web requests with "sex" or "sexygirl" patterns and the other to deny the Web requests with "playboy" pattern to go through the gateway. System will block the Web requests with "sex", "sexygirl" or "playboy" patterns to pass through the gateway.

4G Vehicle Gateway

URL Blocking Setting

Go to **Security > Firewall > URL Blocking** Tab.

In "URL Blocking" page, there are three configuration windows. They are the "Configuration" window, "URL Blocking Rule List" window, and "URL Blocking Rule Configuration" window.

The "Configuration" window can let you activate the URL blocking function and specify to black listing or to white listing the packets defined in the "URL Blocking Rule List" entry. In addition, log alerting can be enabled to record on-going events for any disallowed Web request packets. Refer to "System Status" in "6.1.1 System Related" section in this user manual for how to view recorded log.

The "URL Blocking Rule List" window lists all your defined URL blocking rule entry. And finally, the "URL Blocking Rule Configuration" window can let you define URL blocking rules. The parameters in a rule include the rule name, the Source IP or MAC, the URL/Domain Name/Keyword, the destination service ports, the integrated time schedule rule and the rule activation.

Enable URL Blocking



Item	Setting
▶ URL Blocking	<input checked="" type="checkbox"/> Enable
▶ Black List / White List	Deny those match the following rules. ▼
▶ Log Alert	<input type="checkbox"/> Enable

Configuration Item	Value setting	Description
URL Blocking	The box is unchecked by default	Check the Enable box to activate URL Blocking function.
Black List / White List	Deny those match the following rules is set by default	Specify the URL Blocking Policy, either Black List or White List. Black List: When Deny those match the following rules is selected, as the name suggest, the matched Web request packets will be blocked. White List: When Allow those match the following rules is selected, the matched Web request packets can pass through the Gateway, and the others that don't match the rules will be blocked.
Log Alert	The box is unchecked by default	Check the Enable box to activate Event Log.
Save	NA	Click Save button to save the settings
Undo	NA	Click Undo button to cancel the settings

Create/Edit URL Blocking Rules

The Gateway supports up to a maximum of 20 URL blocking rule sets. Ensure that the URL Blocking is enabled before we can create blocking rules.

4G Vehicle Gateway

ID	Rule Name	Source IP	Source MAC	URL / Domain Name / Keyword	Destination Port	Time Schedule	Enable	Actions
----	-----------	-----------	------------	-----------------------------	------------------	---------------	--------	---------

When **Add** button is applied, the **URL Blocking Rule Configuration** screen will appear.

Item	Setting
▶ Rule Name	<input type="text" value="Rule1"/>
▶ Source IP	<input type="text" value="Any"/>
▶ Source MAC	<input type="text" value="Any"/>
▶ URL / Domain Name / Keyword	<input type="text"/>
▶ Destination Port	<input type="text" value="Any"/>
▶ Time Schedule Rule	<input type="text" value="(0) Always"/>
▶ Rule	<input type="checkbox"/> Enable

Item	Value setting	Description
Rule Name	<ol style="list-style-type: none"> String format can be any text A Must filled setting 	Specify an URL Blocking rule name. Enter a name that is easy for you to understand.
Source IP	<ol style="list-style-type: none"> A Must filled setting Any is set by default 	This field is to specify the Source IP address . <ul style="list-style-type: none"> Select Any to filter packets coming from any IP addresses. Select Specific IP Address to filter packets coming from an IP address entered in this field. Select IP Range to filter packets coming from a specified range of IP address entered in this field. Select IP Address-based Group to filter packets coming from a pre-defined group selected. Note: group must be pre-defined before this option become available. Refer to Object Definition > Grouping > Host grouping.
Source MAC	<ol style="list-style-type: none"> A Must filled setting Any is set by default 	This field is to specify the Source MAC address . <ul style="list-style-type: none"> Select Any to filter packets coming from any MAC addresses. Select Specific MAC Address to filter packets coming from a MAC address entered in this field. Select MAC Address-based Group to filter packets coming from a pre-defined group selected. Note: group must be pre-defined before this selection become available. Refer to Object Definition > Grouping > Host grouping.
URL / Domain Name / Keyword	<ol style="list-style-type: none"> A Must filled setting Supports up to a maximum of 10 Keywords in a rule by using the delimiter “;”. 	Specify URL, Domain Name, or Keyword list for URL checking. <ul style="list-style-type: none"> In the Black List mode, if a matched rule is found, the packets will be dropped. In the White List mode, if a matched rule is found, the packets will be accepted and the others which don't match any rule will be dropped.
Destination Port	<ol style="list-style-type: none"> A Must filled setting Any is set by default 	This field is to specify the Destination Port number . <ul style="list-style-type: none"> Select Any to filter packets going to any Port. Select Specific Service Port to filter packets going to a specific Port entered in this field. Select Port Range to filter packets going to a specific range of Ports entered in this field.
Time Schedule Rule	A Must filled setting	Apply a specific Time Schedule to this rule; otherwise leave it as (0) Always . If the dropdown list is empty ensure Time Schedule is pre-configured. Refer to Object Definition > Scheduling > Configuration tab.

4G Vehicle Gateway

Rule	The box is unchecked by default.	Click the Enable box to activate this rule.
Save	<i>NA</i>	Click the Save button to save the settings.
Undo	<i>NA</i>	Click the X button to cancel the changes and back to last page.

4G Vehicle Gateway

5.2.3 MAC Control

Configuration

Item	Setting
MAC Control	<input checked="" type="checkbox"/> Enable
Black List / White List	Deny MAC Address Below. ▼
Log Alert	<input type="checkbox"/> Enable
Known MAC from LAN PC List	▼ Copy to

MAC Control Rule List Add Delete

ID	Rule Name	MAC Address	Time Schedule Rule	Enable	Actions
----	-----------	-------------	--------------------	--------	---------

"MAC Control" function allows you to assign the accessibility to the gateway for different users based on device's MAC address. When the administrator wants to reject the traffics from some client hosts with specific MAC addresses, he can use the "MAC Control" function to reject with the black list configuration.

MAC Control with Black List Scenario

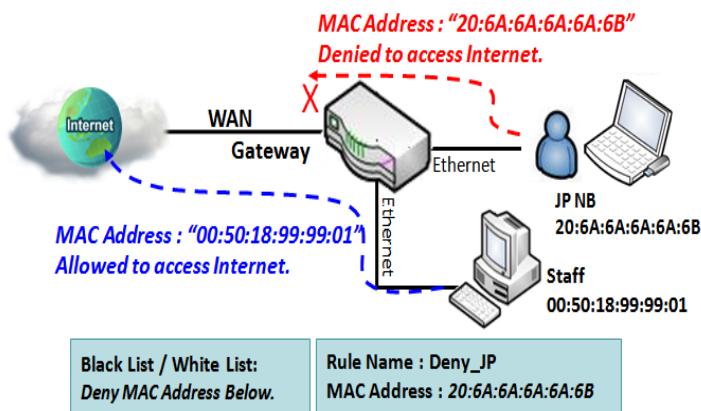

As shown in the diagram, enable the MAC control function and specify the "MAC Control Rule List" is a black list, and configure one MAC control rule for the gateway to deny the connection request from the "JP NB" with its own MAC address 20:6A:6A:6A:6A:6B.

System will block the connecting from the "JP NB" to the gateway but allow others.

4G Vehicle Gateway

MAC Control Setting

Go to **Security > Firewall > MAC Control** Tab.

The MAC control setting allows user to create and customize MAC address policies to allow or reject packets with specific source MAC address.

Enable MAC Control

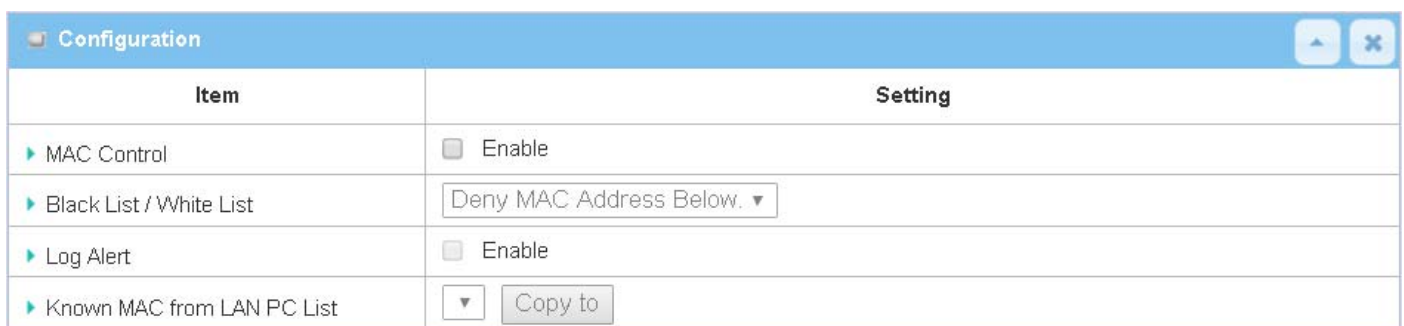

Item	Setting
▶ MAC Control	<input type="checkbox"/> Enable
▶ Black List / White List	Deny MAC Address Below. ▼
▶ Log Alert	<input type="checkbox"/> Enable
▶ Known MAC from LAN PC List	▼ <input type="button" value="Copy to"/>

Configuration Window		
Item	Value setting	Description
MAC Control	The box is unchecked by default	Check the Enable box to activate the MAC filter function
Black List / White List	Deny MAC Address Below is set by default	When Deny MAC Address Below is selected, as the name suggest, packets specified in the rules will be blocked –black listed. In contrast, with Allow MAC Address Below , you can specifically white list the packets to pass and the rest will be blocked.
Log Alert	The box is unchecked by default	Check the Enable box to activate to activate Event Log.
Known MAC from LAN PC List	N/A	Select a MAC Address from LAN Client List. Click the Copy to to copy the selected MAC Address to the filter rule.
Save	N/A	Click Save to save the settings
Undo	N/A	Click Undo to cancel the settings

4G Vehicle Gateway

Create/Edit MAC Control Rules

The gateway supports up to a maximum of 20 filter rule sets. Ensure that the MAC Control is enabled before we can create control rules.

MAC Control Rule List Add Delete ↑ ×					
ID	Rule Name	MAC Address	Time Schedule Rule	Enable	Actions

When **Add** button is applied, **Filter Rule Configuration** screen will appear.

MAC Control Rule Configuration ×			
Rule Name	MAC Address (Use : to Compose)	Time Schedule	Enable
<input type="text" value="Rule1"/>	<input type="text"/>	(0) Always ▾	<input type="checkbox"/>
Save			

MAC Control Rule Configuration		
Item	Value setting	Description
Rule Name	1. String format can be any text 2. A Must fill setting	Enter a MAC Control rule name. Enter a name that is easy for you to remember.
MAC Address (Use: to Compose)	1. MAC Address string Format 2. A Must fill setting	Specify the Source MAC Address to filter rule.
Time Schedule	A Must fill setting	Apply Time Schedule to this rule; otherwise leave it as (0) Always . If the dropdown list is empty, ensure Time Schedule is pre-configured. Refer to Object Definition > Scheduling > Configuration tab
Enable	The box is unchecked by default.	Click Enable box to activate this rule, and then save the settings.
Save	N/A	Click Save to save the settings
Undo	N/A	Click Undo to cancel the settings

4G Vehicle Gateway

5.2.4 Content Filter

Configuration [Help]	
Item	Setting
▶ Web Content Filters	<input type="checkbox"/> Enable
▶ Popular File Extension List	<input type="checkbox"/> Cookie <input type="checkbox"/> Java <input type="checkbox"/> ActiveX
▶ Log Alert	<input type="checkbox"/> Enable

"Content Filter" function can block HTML requests with some specific extension file names, like ".exe", ".bat" (applications), "mpeg" (video), and so on. It also blocks HTML requests with some script types, like Java Applet, Java Scripts, cookies and Active X.

Content Filter Scenario

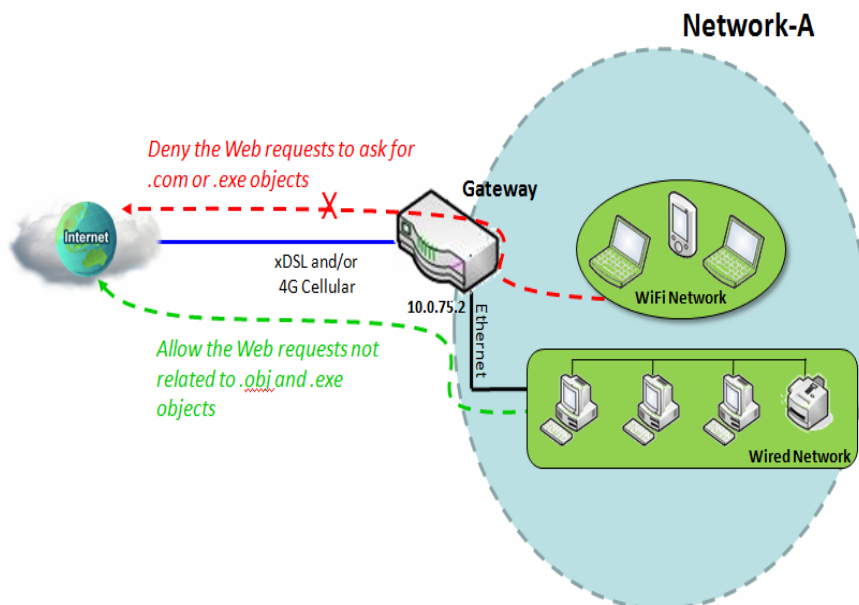

When the administrator of the gateway wants to block the Web requests for dedicated contents or objects, he can use the "Web Content Filters" function to carry out such request blocking.

As shown in the diagram, enable the Web content filters function to check and filter out Web requests on Cookie, Java and ActiveX objects. And then define further with objects in the "Web Content Filter List" that may include extension ".exe" and ".com". System will block requests containing objects with extension ".exe" or ".com".

4G Vehicle Gateway

Content Filter Setting

Go to **Security > Firewall > Content Filter** Tab.

There are three configuration windows for the filtering function. They are the "Configuration" window, "Content Filter List" window, and "Content Filter Configuration" window.

The "Configuration" window can let you activate the web content filtering function. Besides, some popular script types, like Java Applet, Java Scripts, cookies and Active X are in the window and you can check their boxes to enable the gateway to filter out the web requests with corresponding patterns.

Configuration	
Item	Setting
▶ Content Filters	<input type="checkbox"/> Enable
▶ Popular File Extension List	<input type="checkbox"/> Cookie <input type="checkbox"/> Java <input type="checkbox"/> ActiveX
▶ Log Alert	<input type="checkbox"/> Enable

Web Content Filters Tab		
Item	Value setting	Description
Content Filter	The box is unchecked by default.	Check the Enable box to activate this content filter function.
Popular File Extension List	1. A Must filled setting. 2. The boxes are unchecked by default	Check the Cookie box to activate this filter function, as the name suggests, this pattern matching rule define as the packet with the keyword " Cookie: ". Check the Java box to activate this filter function, as the name suggests, this pattern matching rule define as the packet with the keyword ".js", ".class", ".jar", ".jsp", ".java", ".jse", ".jcm", ".jtk", or ".jad". Check the ActiveX box to activate this filter function, as the name suggests, this pattern matching rule define as the packet with the keyword ".ocx", ".cab", ".ole", ".olb", ".com", ".vbs", ".vrm", or ".viv". If one of the matching rules is found, the packets with http header will be dropped.
Log Alert	The box is unchecked by default.	Check the Enable box to activate Event Log.

Create/Edit Content Filter Rule

The gateway supports up to a maximum of 20 filter rule sets. Ensure that the Content Filer is enabled before we can create filter rules.

The "Web Content Filter List" window lists all your defined file extension lists that are used by the gateway to filter out unwanted Web requests, and the "Content Filter Configuration" window can let you define one web Content Filter rule.

4G Vehicle Gateway

ID	Rule Name	Source IP	Source MAC	User-defined File Extension List	Time Schedule	Enable	Actions
----	-----------	-----------	------------	----------------------------------	---------------	--------	---------

When **Add** button is applied, **Content Filter Configuration** screen will appear.

Item	Setting
▶ Rule Name	<input type="text" value="Rule1"/>
▶ Source IP	<input type="text" value="Any"/>
▶ Source MAC	<input type="text" value="Any"/>
▶ User-defined File Extension List (Use ; to Concatenate)	<input type="text"/>
▶ Time Schedule	<input type="text" value="(0) Always"/>
▶ Rule	<input type="checkbox"/> Enable

Item	Value setting	Description
Rule Name	<ol style="list-style-type: none"> String format can be any text. A Must filled setting. 	Enter a content filter rule name that is easy for you to understand.
Source IP	<ol style="list-style-type: none"> A Must filled setting. Any is selected by default. 	<p>Specify the Source IP address to apply with the content filter rule. It can be Any, Specific IP Address, IP Range, or IP Address-based Group. Select Any to filter packets coming from any IP addresses. Select Specific IP Address to filter packets coming from an IP address entered in this field.</p> <p>Select IP Range to filter packets coming from a specified range of IP address entered in this field.</p> <p>Select IP Address-based Group to filter packets coming from a pre-defined group selected.</p> <p>Note: Group must be pre-defined before this selection become available. Refer to Object Definition > Grouping > Host Grouping Tab. You may also access to create a group by the Add Rule shortcut button. Setting done through the Add Rule button will also appear in the Host grouping setting screen.</p>
Source MAC	<ol style="list-style-type: none"> A Must filled setting. Any is selected by default. 	<p>Specify the Source MAC address to apply with the content filter rule. Select Any to filter packets coming from any MAC addresses. Select Specific MAC Address to filter packets coming from a MAC address entered in this field.</p> <p>Select MAC Address-based Group to filter packets coming from a pre-defined group selected.</p> <p>Note: Group must be pre-defined before this selection become available. Refer</p>

4G Vehicle Gateway

		to Object Definition > Grouping > Host Grouping Tab. You may also access to create a group by the Add Rule shortcut button. Setting done through the Add Rule button will also appear in the Host grouping setting screen.
User-defined File Extension List (Use ; to Concatenate)	A Must filled setting	Specify file extension list for the content filter rule. It supports up to a maximum of 10 file extensions in a rule by using the delimiter “;”. If a matching rule is found, the packets with http header will be dropped.
Time Schedule	1. A Must filled setting. 2.(0) Always is selected by default	Apply Time Schedule to this rule, otherwise leave it as Always. If the dropdown list is empty, ensure Time Schedule is pre-configured. Refer to Object Definition > Scheduling > Configuration tab.
Rule	The box is unchecked by default.	Click the Enable box to activate this rule.
Save	N/A	Click the Save button to save the configuration.
Undo	N/A	Click the X button to restore what you just configured back to the previous setting.

4G Vehicle Gateway

5.2.5 Application Filter

Application Filter function can categorize Internet Protocol packets based on their application layer data and allow or deny their passing of gateway. It supports the application filters for various Internet chat software, P2P download, Proxy, and A/V streaming. You can select the applications to be blocked after the function is enabled, and may also specify schedule rule to apply.

Application Filter Scenario

*P2P Software "BT, eDonkey/eMule /Shareaza"
Streaming "MMS, RTSP, PPStream, PPSLive, Qvcd"
Denied to access for those applications.*

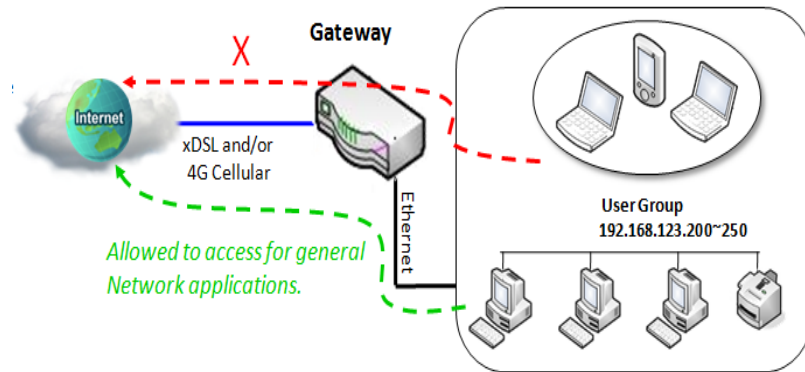

When the administrator of the gateway wants to block some P2P or Stream applications, he can use the "Application Filters" function.

As shown in the diagram, the Gateway is the gateway as a NAT router. Specify IP Range 192.168.123.200~250, and enable the Application filters function "BT(BitTorrent, BitSpirit, BitComet)", "eDonkey/eMule/Shareaza", "MMS", "RTSP", "PPStream", "PPSLive" and "Qvcd" by checking the "Enable" box. The gateway will block those applications to internet.

Application Filter Setting

Go to **Security > Firewall > Application Filter** Tab.

The Application Filter setting allows user to create and customize Application Filter policies to reject packets related to specific applications through the router based on their office setting.

Configuration	
Item	Setting
▶ Application Filters	<input checked="" type="checkbox"/> Enable
▶ Log Alert	<input type="checkbox"/> Enable

Application Filters		
Item	Setting	Description

4G Vehicle Gateway

Application Filter	The box is unchecked by default.	Check the Enable box to activate this application filter function.
Log Alert	The box is unchecked by default.	Check the Enable box to activate Event Log.

Create/Edit Application Filter Rules

The gateway supports up to a maximum of 20 filter rule sets. Ensure that the Application Filers is enabled before we can create filter rules.

Application Filter List						
Rule Name	Source IP	Source MAC	Application	Time Schedule	Enable	Actions

When **Add** button is applied, **Filter Rule Configuration** screen will appear.

Application Filter Rule Configuration	
Item	Setting
▶ Rule Name	<input type="text" value="Rule1"/>
▶ Source IP	<input type="text" value="Any"/>
▶ Source MAC	<input type="text" value="Any"/>
▶ Chat Software	<input type="checkbox"/> QQ <input type="checkbox"/> Skype <input type="checkbox"/> Aliww <input type="checkbox"/> Line
▶ P2P Software	<input type="checkbox"/> BT(BitTorrent, BitSpirit, BitComet) <input type="checkbox"/> HTTP Multiple Thread Download
▶ Streaming	<input type="checkbox"/> MMS <input type="checkbox"/> RTSP
▶ Time Schedule	<input type="text" value="(0) Always"/>
▶ Rule	<input type="checkbox"/> Enable

Application Filter Rule Configuration		
Item	Value setting	Description
Rule Name	1. String format can be any text. 2. A Must filled setting.	Enter an application filter rule name that is easy for you to understand.
Source IP	1. A Must filled setting. 2. Any is selected by default.	Specify the Source IP address to apply with the application filter rule. It can be Any , Specific IP Address , IP Range , or IP Address-based Group . Select Any to filter packets coming from any IP addresses. Select Specific IP Address to filter packets coming from an IP address entered in this field. Select IP Range to filter packets coming from a specified range of IP address entered in this field.

4G Vehicle Gateway

		<p>Select IP Address-based Group to filter packets coming from a pre-defined group selected.</p> <p>Note: Group must be pre-defined before this selection become available. Refer to Object Definition > Grouping > Host Grouping Tab. You may also access to create a group by the Add Rule shortcut button. Setting done through the Add Rule button will also appear in the Host grouping setting screen.</p>
Source MAC	<p>1. A Must filled setting.</p> <p>2. Any is selected by default.</p>	<p>Specify the Source MAC address to apply with the application filter rule.</p> <p>Select Any to filter packets coming from any MAC addresses.</p> <p>Select Specific MAC Address to filter packets coming from a MAC address entered in this field.</p> <p>Select MAC Address-based Group to filter packets coming from a pre-defined group selected.</p> <p>Note: Group must be pre-defined before this selection become available. Refer to Object Definition > Grouping > Host Grouping Tab. You may also access to create a group by the Add Rule shortcut button. Setting done through the Add Rule button will also appear in the Host grouping setting screen.</p>
Chat Software	All boxes are unchecked by default.	<p>Check the box(es) to activate the application filter function you want on this rule.</p> <p>The available chat applications include QQ, Skype, Facebook, Aliww, and Line.</p>
P2P Software	All boxes are unchecked by default.	<p>Check the box(es) to activate the application filter function you want on this rule.</p> <p>The available P2P applications include BT, and HTTP Multiple Thread Download.</p>
Streaming	All boxes are unchecked by default.	<p>Check the box(es) to activate the application filter function you want on this rule.</p> <p>The available streaming applications include MMS, and RTSP.</p>
Time Schedule	<p>1. A Must filled setting.</p> <p>2. (0) Always is selected by default</p>	<p>Apply Time Schedule to this rule; otherwise leave it as (0) Always.</p> <p>If the dropdown list is empty, ensure Time Schedule is pre-configured. Refer to Object Definition > Scheduling > Configuration tab.</p>
Rule	The box is unchecked by default.	Click the Enable box to activate this rule.
Save	N/A	Click the Save button to save the configuration.
Undo	N/A	Click the Undo button to restore what you just configured back to the previous setting.
Back	N/A	When the X button is clicked, the screen will return to the Application Filter Configuration page.

4G Vehicle Gateway

5.2.6 IPS

Configuration	
Item	Setting
▶ IPS	<input type="checkbox"/> Enable
▶ Log Alert	<input type="checkbox"/> Enable

Intrusion Prevention	
Item	Setting
▶ SYN Flood Defense	<input type="checkbox"/> Enable <input type="text" value="300"/> Packets/second (10~10000)
▶ UDP Flood Defense	<input type="checkbox"/> Enable <input type="text" value="300"/> Packets/second (10~10000)
▶ ICMP Flood Defense	<input type="checkbox"/> Enable <input type="text" value="300"/> Packets/second (10~10000)
▶ Port Scan Defense	<input type="checkbox"/> Enable <input type="text" value="200"/> Packets/second (10~10000)

To provide application servers in the Internet, administrator may need to open specific ports for the services. However, there are some risks to always open service ports in the Internet. In order to avoid such attack risks, it is important to enable IPS functions.

Intrusion Prevention System (IPS) is network security appliances that monitor network and/or system activities for malicious activity. The main functions of IPS are to identify malicious activity, log information about this activity, attempt to block/stop it and report it. You can enable the IPS function and check the listed intrusion activities when needed. You can also enable the log alerting so that system will record Intrusion events when corresponding intrusions are detected.

IPS Scenario

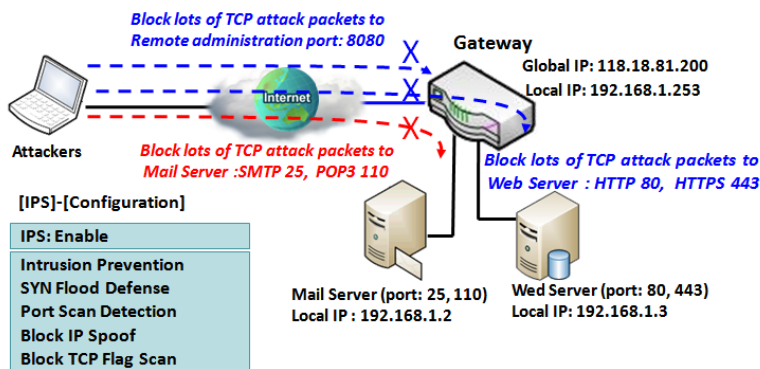

As shown in the diagram, the gateway serves as an E-mail server, Web Server and also provides TCP port 8080 for remote administration. So, remote users or unknown users can request those services from Internet. With IPS enabled, the gateway can detect incoming attack packets, including the TCP ports (25, 80, 110, 443 and 8080) with services. It will block the attack packets and let the normal access to pass through the gateway

4G Vehicle Gateway

IPS Setting

Go to **Security > Firewall > IPS** Tab.

The Intrusion Prevention System (IPS) setting allows user to customize intrusion prevention rules to prevent malicious packets.

Enable IPS Firewall

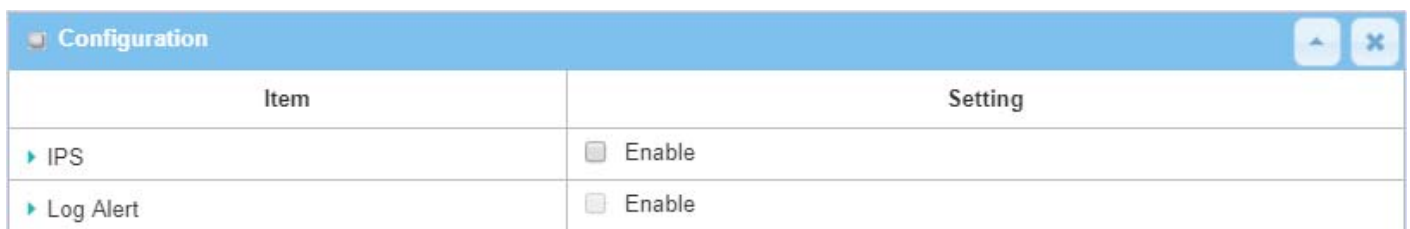

The screenshot shows a configuration window titled "Configuration" with a table of settings. The table has two columns: "Item" and "Setting".

Item	Setting
▶ IPS	<input type="checkbox"/> Enable
▶ Log Alert	<input type="checkbox"/> Enable

Configuration Window		
Item	Value setting	Description
IPS	The box is unchecked by default	Check the Enable box to activate IPS function
Log Alert	The box is unchecked by default	Check the Enable box to activate to activate Event Log.
Save	N/A	Click Save to save the settings
Undo	N/A	Click Undo to cancel the settings

Setup Intrusion Prevention Rules

The router allows you to select intrusion prevention rules you may want to enable. Ensure that the IPS is enabled before we can enable the defense function.

4G Vehicle Gateway

Intrusion Prevention	
Item	Setting
▶ SYN Flood Defense	<input type="checkbox"/> Enable <input type="text" value="300"/> Packets/second (10~10000)
▶ UDP Flood Defense	<input type="checkbox"/> Enable <input type="text" value="300"/> Packets/second (10~10000)
▶ ICMP Flood Defense	<input type="checkbox"/> Enable <input type="text" value="300"/> Packets/second (10~10000)
▶ Port Scan Defense	<input type="checkbox"/> Enable <input type="text" value="200"/> Packets/second (10~10000)
▶ Block Land Attack	<input type="checkbox"/> Enable
▶ Block Ping of Death	<input type="checkbox"/> Enable
▶ Block IP Spoof	<input type="checkbox"/> Enable
▶ Block TCP Flag Scan	<input type="checkbox"/> Enable
▶ Block Smurf	<input type="checkbox"/> Enable
▶ Block Traceroute	<input type="checkbox"/> Enable
▶ Block Fraggle Attack	<input type="checkbox"/> Enable
▶ ARP Spoofing Defense	<input type="checkbox"/> Enable <input type="text" value="300"/> Packets/second (10~10000)

Setup Intrusion Prevention Rules		
Item Name	Value setting	Description
SYN Flood Defense	1. A Must filled setting	Click Enable box to activate this intrusion prevention rule and enter the traffic threshold in this field.
UDP Flood Defense	2. The box is unchecked by default.	Click Enable box to activate this intrusion prevention rule and enter the traffic threshold in this field.
ICMP Flood Defense	3. Traffic threshold is set to 300 by default 4. The value range can be from 10 to 10000.	Click Enable box to activate this intrusion prevention rule and enter the traffic threshold in this field. Value Range: 10 ~ 10000.
Port Scan Defection	1. A Must filled setting 2. The box is unchecked by default. 3. Traffic threshold is set to 200 by default 4. The value range can be from 10 to 10000.	Click Enable box to activate this intrusion prevention rule and enter the traffic threshold in this field. Value Range: 10 ~ 10000.
Block Land Attack Block Ping of Death Block IP Spoof Block TCP Flag Scan Block Smurf Block Traceroute Block Fraggle	The box is unchecked by default.	Click Enable box to activate this intrusion prevention rule.

4G Vehicle Gateway

Attack		
ARP Spoofing Defence	<ol style="list-style-type: none">1. A Must filled setting2. The box is unchecked by default.3. Traffic threshold is set to 300 by default4. The value range can be from 10 to 10000.	Click Enable box to activate this intrusion prevention rule and enter the traffic threshold in this field. <i>Value Range: 10 ~ 10000.</i>
Save	NA	Click Save to save the settings
Undo	NA	Click Undo to cancel the settings

4G Vehicle Gateway

5.2.7 Options

Firewall Options

Item	Setting
▶ Stealth Mode	<input type="checkbox"/> Enable
▶ SPI	<input checked="" type="checkbox"/> Enable
▶ Discard Ping from WAN	<input type="checkbox"/> Enable

Remote Administrator Host Definition

ID	Interface	Protocol	IP	Subnet Mask	Service Port	Enable	Action
1	All WAN	HTTPS	Any IP	N/A	443	<input type="checkbox"/>	Edit
2	All WAN	HTTPS	Any IP	N/A	443	<input type="checkbox"/>	Edit
3	All WAN	HTTPS	Any IP	N/A	443	<input type="checkbox"/>	Edit
4	All WAN	HTTPS	Any IP	N/A	443	<input type="checkbox"/>	Edit
5	All WAN	HTTPS	Any IP	N/A	443	<input type="checkbox"/>	Edit

There are some additional useful firewall options in this page.

“Stealth Mode” lets gateway not to respond to port scans from the WAN so that makes it less susceptible to discovery and attacks on the Internet. “SPI” enables gateway to record the packet information like IP address, port address, ACK, SEQ number and so on while they pass through the gateway, and the gateway checks every incoming packet to detect if this packet is valid.

“Discard Ping from WAN” makes any host on the WAN side can't ping this gateway. And finally, “Remote Administrator Hosts” enables you to perform administration task from a remote host. If this feature is enabled, only specified IP address(es) can perform remote administration.

4G Vehicle Gateway

Enable SPI Scenario

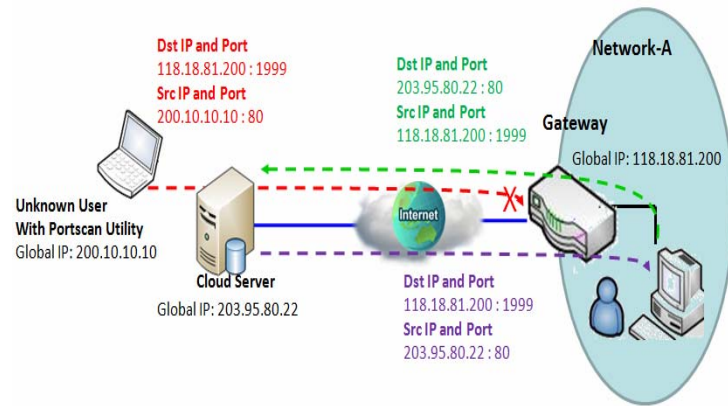

As shown in the diagram, Gateway has the IP address of 118.18.81.200 for WAN interface and 192.168.1.253 for LAN interface. It serves as a NAT gateway. Users in Network-A initiate to access cloud server through the gateway. Sometimes, unknown users will simulate the packets but use different source IP to masquerade. With the SPI feature been enabled at the gateway, it will block such packets from unknown users.

Discard Ping from WAN & Remote Administrator Hosts Scenario

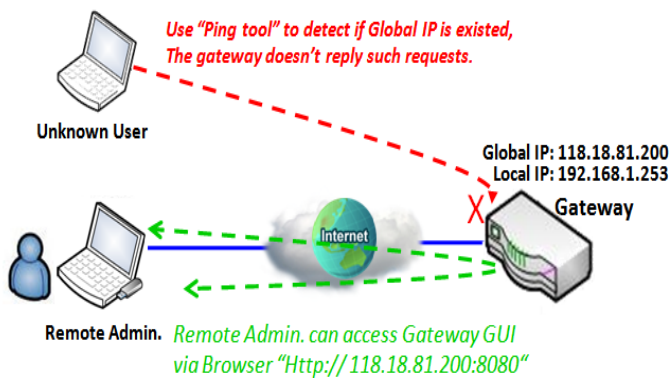

"Discard Ping from WAN" makes any host on the WAN side can't ping this gateway reply any ICMP packets. Enable the Discard Ping from WAN function to prevent security leak when local users surf the internet.

Remote administrator knows the gateway's global IP, and he can access the Gateway GUI via TCP port 8080.

4G Vehicle Gateway

Firewall Options Setting

Go to **Security > Firewall > Options** Tab.

The firewall options setting allows network administrator to modify the behavior of the firewall and to enable Remote Router Access Control.

Enable Firewall Options

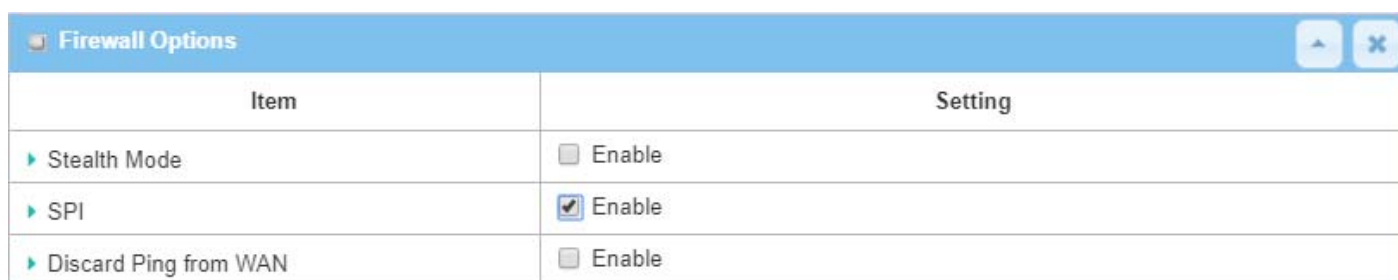

Item	Setting
▶ Stealth Mode	<input type="checkbox"/> Enable
▶ SPI	<input checked="" type="checkbox"/> Enable
▶ Discard Ping from WAN	<input type="checkbox"/> Enable

Firewall Options		
Item	Value setting	Description
Stealth Mode	The box is unchecked by default	Check the Enable box to activate the Stealth Mode function
SPI	The box is checked by default	Check the Enable box to activate the SPI function
Discard Ping from WAN	The box is unchecked by default	Check the Enable box to activate the Discard Ping from WAN function

Define Remote Administrator Host

The router allows network administrator to manage router remotely. The network administrator can assign specific IP address and service port to allow accessing the router via designated WAN interface.

4G Vehicle Gateway

Remote Administrator Host Definition							
ID	Interface	Protocol	IP	Subnet Mask	Service Port	Enable	Action
1	All WAN	HTTPS	Any IP	N/A	443	<input type="checkbox"/>	Edit
2	All WAN	HTTPS	Any IP	N/A	443	<input type="checkbox"/>	Edit
3	All WAN	HTTPS	Any IP	N/A	443	<input type="checkbox"/>	Edit
4	All WAN	HTTPS	Any IP	N/A	443	<input type="checkbox"/>	Edit
5	All WAN	HTTPS	Any IP	N/A	443	<input type="checkbox"/>	Edit

Remote Administrator Host Definition		
Item	Value setting	Description
Protocol	HTTPS is set by default	Select HTTP or HTTPS method for remote administration.
IP	A Must filled setting	This field is to specify the remote host to assign access right for remote access. Select Any IP to allow any remote hosts Select Specific IP to allow the remote host coming from a specific subnet. An IP address entered in this field and a selected Subnet Mask to compose the subnet.
Service Port	1. 80 for HTTP by default 2. 443 for HTTPS by default	This field is to specify a Service Port to HTTP or HTTPS connection. Value Range: 1 ~ 65535.
Enabling the rule	The box is unchecked by default.	Click Enable box to activate this rule.
Save	N/A	Click Enable box to activate this rule then save the settings.
Undo	N/A	Click Undo to cancel the settings

4G Vehicle Gateway

5.3 Authentication

To approve or confirm the truth of a certain object, you have to configure the required settings in the Authentication page. The supported functions could be Captive Portal and MAC Authentication, and the available function might be different for the purchased gateway. With proper configuration, whenever a certain object is accessing the portal or is asked for authentication to get access to internet, the specified authentication server is responsible for the authentication.

5.3.1 Captive Portal

A captive portal is a portal web page that is displayed before a user can browse Internet. The portal is often used to present a login page. This is done by intercepting most packets, regardless of address or port, until the user opens a browser and tries to access the web. At that time the browser is redirected to a web page which may require authentication and/or payment, or simply display an acceptable use policy and require the user to agree. Captive portals are used at many Wi-Fi hotspot services, and can be used to control wired access (e.g. apartment houses, hotel rooms, business centers, "open" Ethernet jacks) as well.¹¹

The gateway supports the Captive Portal function to ask guests or passengers to pass the authentication process before they can surf the Internet via the gateway. There are two approaches, including external captive portal and internal captive portal.

For external captive portal, you must specify external RADIUS (Remote Authentication Dial In User Service) server and external UAM (Universal Access Method) server. In contrast, for internal captive portal, you will only select "Internal RADIUS Server" option for user authentication. The user account database can be an embedded database, an external AD database or an external LDAP database. However, the UAM server is not necessary for this case and that the captive portal Web site is embedded in the device.

Note: Internal captive portal may NOT be supported by the purchased gateway. It depends on the product specification.

External Captive Portal

For external captive portal, you must specify external RADIUS (Remote Authentication Dial In User Service) server and external UAM (Universal Access Method) server.

Before enabling the external Captive Portal function, please go to **[Object Definition]-[External Server]** to setup external server objects, like RADIUS server and UAM server. Then return to configure Captive Portal function back in this page to specific WAN Interface, select external Authentication Server and UAM Server from the pre-defined external server object list.

¹¹ http://en.wikipedia.org/wiki/Captive_portal

4G Vehicle Gateway

Internal Captive Portal

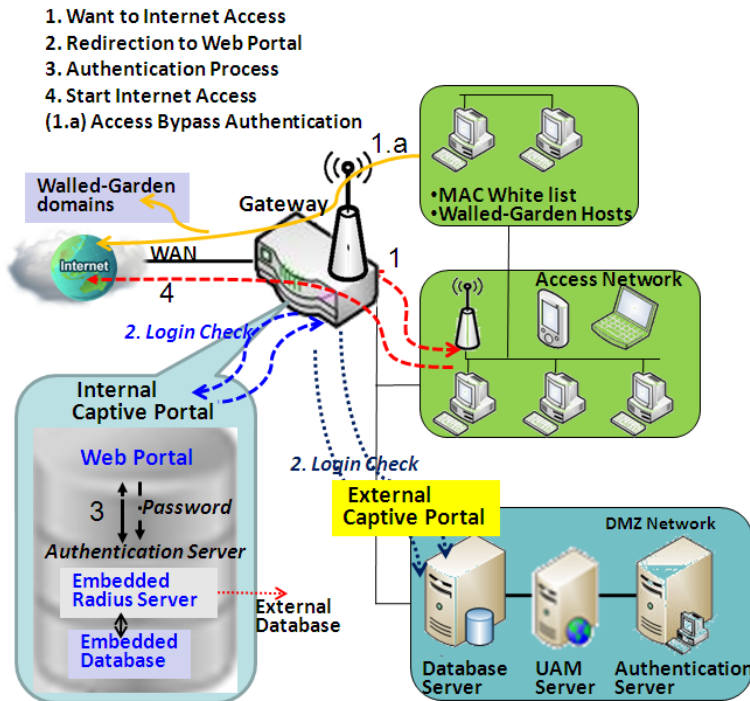

In contrast, for internal captive portal, you will only select “Internal RADIUS Server” option for user authentication. The user account database can be an embedded database, an external AD database or an external LDAP database. However, the UAM server is not necessary for this case and that the captive portal Web site is embedded in the device.

Before enabling internal Captive Portal function, please go to **[Object Definition]-[External Server]** to define some external server objects, like LDAP server or AD server if necessary. Then return to configure Captive Portal function back in this page to specific WAN Interface, select “Internal RADIUS Server” option for user authentication and specify its user database to be the embedded one, an external LDAP server or an external AD server from the pre-defined external server object list.

NOTE: All Internet Packets will be forwarded to Captive Portal Web site of the gateway when Captive portal feature is enabled. Please make sure that at least one user account is created.

Once the user authentication process completes successfully, the gateway redirects the web page to the requested one. Furthermore, the gateway also records the MAC address of guest client host and allows its incoming Internet access requests.

Each account has its own lease time and it will not be reused for authentication once the lease time has run out. The client host with that account will be rejected to surf the Internet.

However, there is a timeout setting for each account. When the client host with that account has been idle at the Internet surfing for a while that reaches the timeout setting, the gateway will re-authenticate the client host for further Internet connection.

4G Vehicle Gateway

Captive Portal Setting

Go to **Security > Authentication > Captive Portal** tab.

The gateway supports the Captive Portal function to ask connecting users to pass the authentication process before they can surf the Internet via the gateway. The Captive Portal will re-direct user to a login page when user try to access the Internet.

Captive Portal Configuration	
Item	Setting
▶ Captive Portal	<input type="checkbox"/> Enable
▶ WAN Interface	WAN-1 ▼
▶ LAN Subnet	DHCP-1 ▼
▶ Web Portal	Internal ▼
▶ Customize login page	<input type="button" value="Download Default CSS and Logo"/> <input type="button" value="Download Current CSS and Logo"/> <input type="button" value="選擇檔案"/> 未選擇任何檔案 <input type="button" value="Upload CSS and Logo files"/>
▶ MAC Whitelist (Separated by ,)	
▶ Walled-Garden Hosts (Separated by ;)	
▶ Walled-Garden domains (Separated by ;)	
▶ Authentication Server	Internal RADIUS Server ▼ Embedded DataBase ▼

Captive Portal Configuration		
Item	Value setting	Description
Captive Portal	The box is unchecked by default	Check the Enable box to activate the Captive Portal function.
WAN Interface	1. A Must filled setting. 2. WAN-1 is selected by default.	Specify a WAN Interface for the authenticated clients or hosts. All the traffics coming from the hosts will be directed to the specified WAN interface.
LAN Subnet	1. A Must filled setting.	Specify the LAN subnet which is to be bound with captive portal function.

4G Vehicle Gateway

	2. DHCP-1 is selected by default.	It can be DHCP-1 ~ DHCP-4, if you configured the corresponding DHCP servers in Basic Network > LAN & VLAN > DHCP Server . If DHCP-1 is selected, users connected to the physical LAN port which bound the DHCP-1 server, will be re-directed to a login page when accessing the Internet.
Web Portal	1. A Must filled setting. 2. The default setting depends on the product specification. It can be Internal or External .	Specify which kind of authentication server is to be used for captive portal function. It can be Internal , External , or Terms and Conditions Only , and depends on the product specification. <i>Not all products with internal option.</i> When External is selected, there is no Customize login page to be configured, but user must specify external UAM Server and Authentication Server for authentication. When Internal is selected, user just needs to specify an Authentication Server and the portal login page can be edited in Customize login page .
Customize login page	N/A	Customize login page is available only when Internal , or Terms and Conditions Only Web Portal is selected. Click the Download Default CSS and Logo button to download the default CSS file and Logo of login page for the internal authentication server. Click the Download Current CSS and Logo button to download the current CSS file and Logo of login page for the internal authentication server. User can edit the CSS file or Logo downloaded from above buttons and upload them by Upload CSS and Logo files button.
MAC Whitelist (Separated by ,)	Optional setting	Specify a MAC whitelist for the client devices that will not be subjected to the captive portal authentication function. The MAC(s) filled in this field can access Internet directly, instead of been re-direct to the login page.
Walled-Garden Hosts (Separated by ;)	Optional setting	Specify the host IP(s) for the devices that will not be subjected to the captive portal authentication function. The IP(s) filled in this field can access Internet directly, instead of been re-direct to the login page.
Walled-Garden domains (Separated by ;)	Optional setting	Specify the domain name(s) for the devices that will not be subjected to the captive portal authentication function. The domain names(s) filled in this field can access Internet directly, instead of been re-direct to the login page.
Authentication Server	A Must filled setting	Select the type of authentication server and corresponding user database. If Web Portal is Internal , the Internal RADIUS Server is used to authentication by default, and there are three databases you can choose. When Embedded DataBase is selected, the login IDs and Passwords are created in Object Definition > User > User Profile tab. When External LDAP is selected, the login IDs and passwords are from an external LDAP server. Please specify it as well. When External AD is selected, the login IDs and passwords are from an external AD server. Please specify it as well. If Web Portal is External , the External RADIUS Server is used to authentication by default, user need to specify the external RADIUS server. The external radius server can be added by pressing AddObject button directly or added in Object Definition > External Server > External Server tab.
Save	N/A	Click the Save button to save changes
Refresh	N/A	Click the Refresh button to refresh current page

4G Vehicle Gateway

5.3.2 MAC Authentication

For some application, a RADIUS server is used to authenticate the Internet accessing permission. For those authorized devices (MACs), they are allowed to access internet, and on the other hand, for those not authorized devices, the internet accessing traffics will be blocked.

This gateway supports such MAC authentication function, the administrator has to configure the settings and create a permissible user account list for those authorized devices. When the MAC Authentication function is enabled, the traffics from the specified interface(s) will be applied with the MAC Authentication process transparently. The gateway will interact with the RADIUS server, and provide the corresponding user information for authentication process.

Go to **Security > Authentication > MAC Authentication** tab.

Enable MAC Authentication

Configuration	
Item	Setting
Mac Authentication	<input type="checkbox"/> Enable
Radius Server	--- Option --- <input type="button" value="Add Object"/>
LAN Interface	<input type="checkbox"/> LAN
Client Connection Idle Time	<input type="text"/> (20 - 6000 Seconds)

Configuration		
Item	Value setting	Description
MAC Authentication	The box is unchecked by default.	Check the Enable box to activate the MAC Authentication function.
Radius Server	A Must filled setting.	Specify an external RADIUS server for authentication. When the MAC Authentication is enabled, the gateway sends out the connecting client's information to the RADIUS server for authentication.
LAN Interface	A Must filled setting.	Select the network interface(s) to apply the MAC Authentication function. It can be LAN or VLAN(s) (port-based). At least, one interface should be selected. Note: DON'T choose the interface which RADIUS server in it.
Client Connection Idle Time	A Must filled setting.	Specify the idle time (in seconds) for a client connection. If a client didn't access network for the specified idle time period, its authentication will be invalidated consequently.
Save	N/A	Click the Save button to save changes
Refresh	N/A	Click the Refresh button to refresh current page

Create/Edit User List

There is a User List for listing the information of the available users. Administrator can create, edit, delete, or even search with a certain key and filter function to quick access to the information you are looking for.

4G Vehicle Gateway

User List Filter by None Add Delete admin Filter
Previous Next

ID	Nickname	User Name	Password	Actions
----	----------	-----------	----------	---------

Item	Value setting	Description
Nickname	N/A	It displays the nickname for a user.
User Name	N/A	It displays the MAC address for a user.
Password	N/A	It displays the password for a user.
Add	N/A	Add information of new device authentication
Delete	N/A	Delete information of exists device authentication
Filter	N/A	Search information of exists device authentication
Previous	N/A	Navigation Button of authentication list
Next	N/A	Navigation Button of authentication list

When **Add** button is applied, **User Configuration** screen will appear.

User Configuration Save

Item	Setting
Nickname	<input type="text"/>
User Name	<input type="text"/>
Password	<input type="text"/>

Item	Value setting	Description
Nickname	1. A Must filled setting. 2. String format can be any text (max. 64 characters).	Enter a nickname for the user that is easy for you to understand. Value Range: 1 ~ 64 characters.
User Name	1. A Must filled setting. 2. MAC address format.	Enter the MAC address for the user. Value Range: 0 ~ 17 characters, MAC format with ':' or '-'.
Password	1. A Must filled setting. 2. String format can be any text (max. 64 characters).	Enter the password for the user.
Save	N/A	Click the Save button to save changes.

To make sure the MAC authentication function can work properly on those authorized users (MACs), administrator has to create the corresponding user information in the User List. Otherwise, even for those authorized users, the authentication result will be false, and there will be no internet access for the users.

Chapter 6 Administration

6.1 Configure & Manage

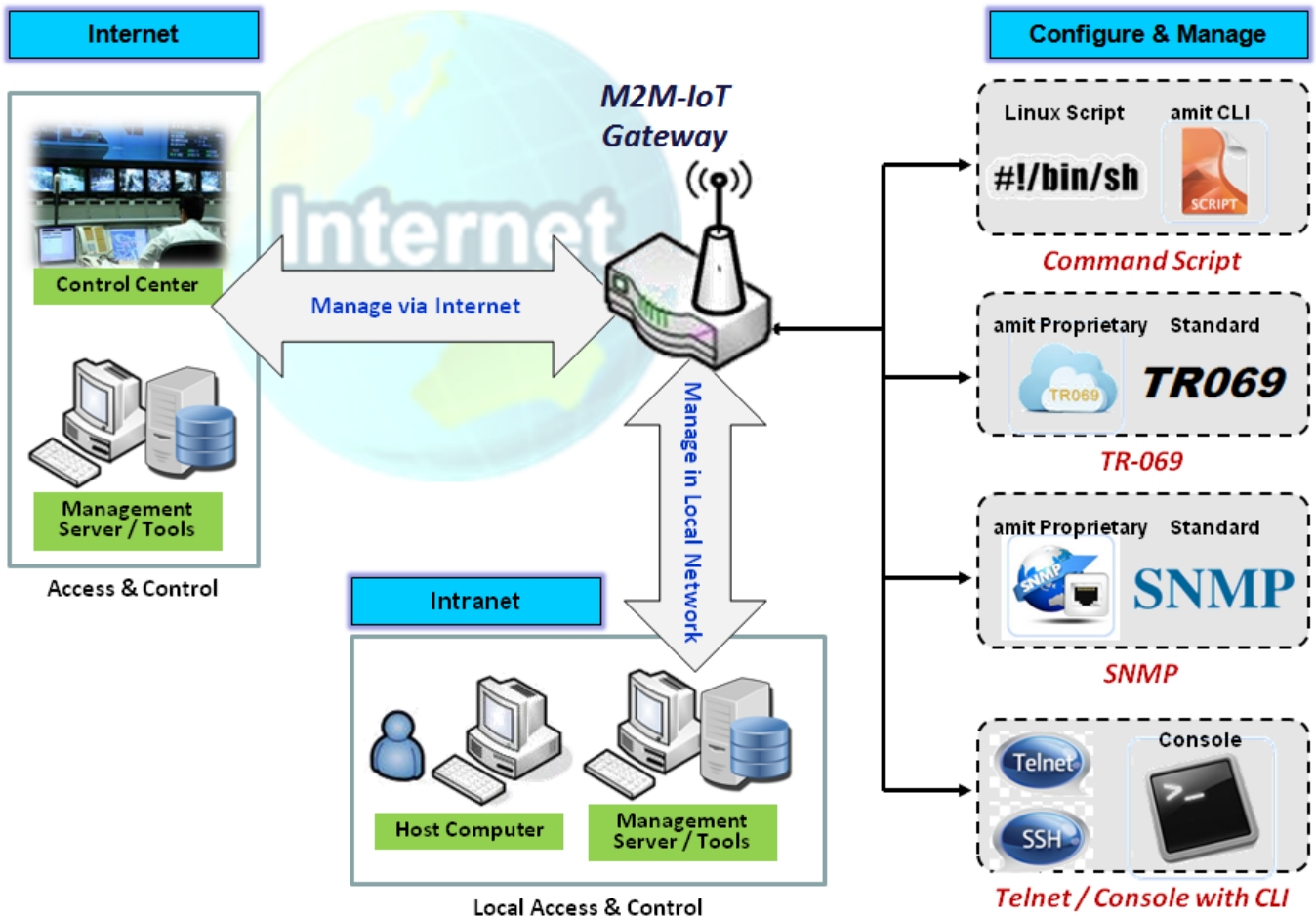

Configure & Manage refers to enterprise-wide administration of distributed systems including (and commonly in practice) computer systems. Centralized management has a time and effort trade-off that is related to the size of the company, the expertise of the IT staff, and the amount of technology being used. This device supports many system management protocols, such as Command Script, TR-069, SNMP, and Telnet with CLI. You can setup those configurations in the "Configure & Manage" section.

4G Vehicle Gateway

6.1.1 Command Script

Command script configuration is the application that allows administrator to setup the pre-defined configuration in plain text style and apply configuration on startup.

Go to **Administration > Command Script > Configuration Tab**.

Enable Command Script Configuration

Item	Setting
▶ Command Script	<input type="checkbox"/> Enable
▶ Backup Script	Via Web UI
▶ Upload Script	Via Web UI
▶ Script Name	<input type="text"/>
▶ Version	<input type="text"/>
▶ Description	<input type="text"/>
▶ Update time	2019-04-08T18:05:31

Configuration Item	Value setting	Description
Command Script	The box is unchecked by default	Check the Enable box to activate the Command Script function.
Backup Script	N/A	Click the Via Web UI or Via Storage button to backup the existed command script in a .txt file. You can specify the script file name in Script Name below.
Upload Script	N/A	Click the Via Web UI or Via Storage button to Upload the existed command script from a specified .txt file.
Script Name	1.An Optional setting 2. Any valid file name	Specify a script file name for script backup, or display the selected upload script file name. Value Range: 0 ~ 32 characters.
Version	1.An Optional setting 2.Any string	Specify the version number for the applied Command script. Value Range: 0 ~ 32 characters.
Description	1.An Optional setting 2.Any string	Enter a short description for the applied Command script.
Update time	N/A	It records the upload time for last commad script upload.

4G Vehicle Gateway

Edit/Backup Plain Text Command Script

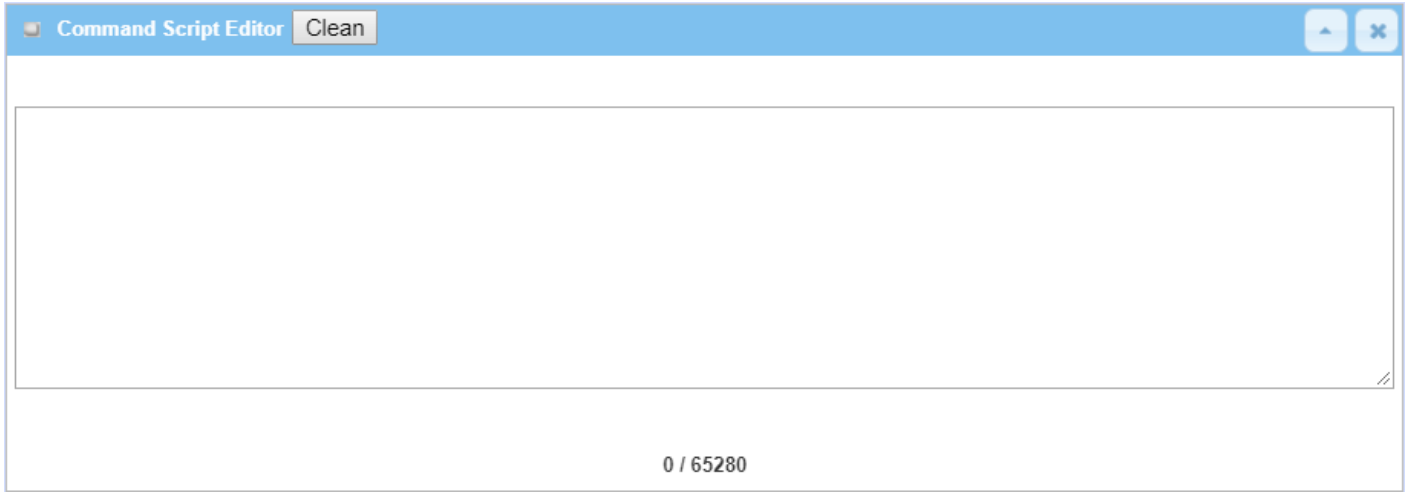

You can edit the plain text configuration settings in the configuration screen as above.

Plain Text Configuration		
Item	Value setting	Description
Clean	NA	Clean text area. (You should click Save button to further clean the configuration already saved in the system.)
Backup	NA	Backup and download configuration.
Save	NA	Save configuration

The supported plain text configuration items are shown in the following list. For the settings that can be executed with standard Linux commands, you can put them in a script file, and apply to the system configure with **STARTUP** command. For those configurations without corresponding Linux command set to configure, you can configure them with proprietary command set.

Configuration Content		
Key	Value setting	Description
OPENVPN_ENABLED	1 : enable 0 : disable	Enable or disable OpenVPN Client function.
OPENVPN_DESCRIPTION	A Must filled Setting	Specify the tunnel name for the OpenVPN Client connection.
OPENVPN_PROTO	udp tcp	Define the Protocol for the OpenVPN Client. <ul style="list-style-type: none"> • Select TCP or TCP /UDP ->The OpenVPN will use TCP protocol, and Port will be set as 443 automatically. • Select UDP -> The OpenVPN will use UDP protocol, and Port will be set as 1194 automatically.
OPENVPN_PORT	A Must filled Setting	Specify the Port for the OpenVPN Client to use.
OPENVPN_REMOTE_IPADDR	IP or FQDN	Specify the Remote IP/FQDN of the peer OpenVPN Server for this OpenVPN Client tunnel. Fill in the IP address or FQDN.
OPENVPN_PING_INTVL	seconds	Specify the time interval for OpenVPN keep-alive checking.

4G Vehicle Gateway

OPENVPN_PING_TOUT	seconds	Specify the timeout value for OpenVPN Client keep-alive checking.
OPENVPN_COMP	Adaptive	Specify the LZO Compression algorithm for OpenVPN client.
OPENVPN_AUTH	Static Key/TLS	Specify the authorization mode for the OpenVPN tunnel. <ul style="list-style-type: none"> • TLS ->The OpenVPN will use TLS authorization mode, and the following items CA Cert. , Client Cert. and Client Key need to specify as well.
OPENVPN_CA_CERT	A Must filled Setting	Specify the Trusted CA certificate for the OpenVPN client. It will go through Base64 Conversion.
OPENVPN_LOCAL_CERT	A Must filled Setting	Specify the local certificate for OpenVPN client. It will go through Base64 Conversion.
OPENVPN_LOCAL_KEY	A Must filled Setting	Specify the local key for the OpenVPN client. It will go through Base64 Conversion.
OPENVPN_EXTRA_OPTS	Options	Specify the extra options setting for the OpenVPN client.
IP_ADDR1	Ip	Ethernet LAN IP
IP_NETM1	Net mask	Ethernet LAN MASK
PPP_MONITORING	1 : enable 0 : disable	When the Network Monitoring feature is enabled, the router will use DNS Query or ICMP to periodically check Internet connection – connected or disconnected.
PPP_PING	0 : DNS Query 1 : ICMP Query	With DNS Query , the system checks the connection by sending DNS Query packets to the destination specified in PPP_PING_IPADDR. With ICMP Query , the system will check connection by sending ICMP request packets to the destination specified in PPP_PING_IPADDR.
PPP_PING_IPADDR	IP	Specify an IP address as the target for sending DNS query/ICMP request.
PPP_PING_INTVL	seconds	Specify the time interval for between two DNS Query or ICMP checking packets.
STARTUP	Script file	For the configurations that can be configured with standard Linux commands, you can put them in a script file, and apply the script file with STARTUP command. For example, STARTUP=#!/bin/sh STARTUP=echo "startup done" > /tmp/demo

Plain Text System Configuration with Telnet

In addition to the web-style plain text configuration as mentioned above, the gateway system also allow the configuration via Telnet CLI. Administrator can use the proprietary telnet command "**txtConfig**" and related action items to perform the plain system configuration.

The command format is: `txtConfig (action) [option]`

Action	Option	Description
clone	<i>Output file</i>	Duplicate the configuration content from database and stored as a configuration file. (ex: <code>txtConfig clone /tmp/config</code>) The contents in the configuration file are the same as the plain text commands mentioned above. This action is exactly the same as performing the "Backup" plain text configuration.

4G Vehicle Gateway

commit	a existing file	Commit the configuration content to database. (ex: <i>txtConfig commit /tmp/config</i>)
enable	NA	Enable plain text system config. (ex: <i>txtConfig enable</i>)
disable	NA	Disable plain text system config. (ex: <i>txtConfig disable</i>)
run_immediately	NA	Apply the configuration content that has been committed in database. (ex: <i>txtConfig run_immediately</i>)
run_immediately	a existing file	Assign a configuration file to apply. (ex: <i>txtConfig run_immediately /tmp/config</i>)

4G Vehicle Gateway

6.1.2 TR-069

TR-069 (Technical Report 069) is a Broadband Forum technical specification entitled CPE WAN Management Protocol (CWMP). It defines an application layer protocol for remote management of end-user devices, like this gateway device. As a bidirectional SOAP/HTTP-based protocol, it provides the communication between customer-premises equipment (CPE) and Auto Configuration Servers (ACS). The Security Gateway is such CPE.

TR-069 is a customized feature for ISP. It is not recommend that you change the configuration for this. If you have any problem in using this feature for device management, please contact with your ISP or the ACS provider for help. At the right upper corner of TR-069 Setting screen, one “[Help]” command let you see the same message about that.

Scenario - Managing deployed gateways through an ACS Server

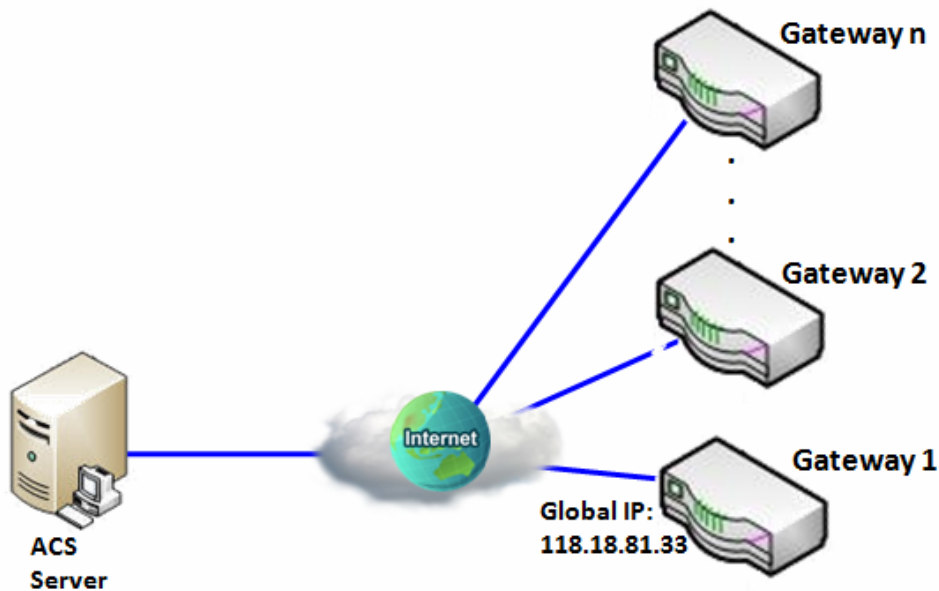

Scenario Application Timing

When the enterprise data center wants to use an ACS server to manage remote gateways geographically distributed elsewhere in the world, the gateways in all branch offices must have an embedded TR-069 agent to communicate with the ACS server. So that the ACS server can configure, FW upgrade and monitor these gateways and their corresponding Intranets.

Scenario Description

The ACS server can configure, upgrade with latest FW and monitor these gateways.

Remote gateways inquire the ACS server for jobs to do in each time period.

The ACS server can ask the gateways to execute some urgent jobs.

4G Vehicle Gateway

Parameter Setup Example

Following tables list the parameter configuration as an example for the Gateway 1 in above diagram with "TR-069" enabling.

Use default value for those parameters that are not mentioned in the tables.

Configuration Path	[TR-069]-[Configuration]
TR-069	■ <i>Enable</i>
ACS URL	http://qa.acslite.com/cpe.php
ACS User Name	<i>ACSUserName</i>
ACS Password	<i>ACSPassword</i>
ConnectionRequest Port	<i>8099</i>
ConnectionRequest User Name	<i>ConnReqUserName</i>
ConnectionRequest Password	<i>ConnReqPassword</i>
Inform	■ <i>Enable Interval 900</i>

Scenario Operation Procedure

In above diagram, the ACS server can manage multiple gateways in the Internet. The "Gateway 1" is one of them and has 118.18.81.33 IP address for its WAN-1 interface.

When all remote gateways have booted up, they will try to connect to the ACS server.

Once the connections are established successfully, the ACS server can configure, upgrade with latest FW and monitor these gateways.

Remote gateways inquire the ACS server for jobs to do in each time period.

If the ACS server needs some urgent jobs to be done by the gateways, it will issue the "Connection Request" command to those gateways. And those gateways make immediate connections in response to the ACS server's immediate connection request for executing the urgent jobs.

4G Vehicle Gateway

TR-069 Setting

Go to **Administration > Configure & Manage > TR-069** tab.

In "TR-069" page, there is only one configuration window for TR-069 function. In the window, you must specify the related information for your security gateway to connect to the ACS. Drive the function to work by specifying the URL of the ACS server, the account information to login the ACS server, the service port and the account information for connection requesting from the ACS server, and the time interval for job inquiry. Except the inquiry time, there are no activities between the ACS server and the gateways until the next inquiry cycle. But if the ACS server has new jobs that are expected to do by the gateways urgently, it will ask these gateways by using connection request related information for immediate connection for inquiring jobs and executing.

Enable TR-069

Item	Setting
▶ TR-069	<input checked="" type="checkbox"/> Enable
▶ Interface	WAN-1 ▾
▶ Data model	ACS Cloud Data Model ▾
▶ ACS URL	<input type="text"/>
▶ ACS UserName	<input type="text"/>
▶ ACS Password	<input type="password"/>
▶ Connection Request Port	8099
▶ Connection Request UserName	<input type="text"/>
▶ Connection Request Password	<input type="password"/>
▶ Inform	<input checked="" type="checkbox"/> Enable Interval <input type="text" value="300"/>
▶ Certification Setup	<input checked="" type="radio"/> default <input type="radio"/> Select from Certificate List Certificate: <input type="text" value="CA"/> ▾

TR-069

Item	Value setting	Description
------	---------------	-------------

4G Vehicle Gateway

TR-069	The box is unchecked by default	Check the Enable box to activate TR-069 function.
Interface	WAN-1 is selected by default.	When you finish set basic network WAN-1 ~ WAN-n, you can choose WAN-1 ~ WAN-n When you finish set Security > VPN > IPSec/OpenVPN/PPTP/L2TP/GRE, you can choose IPSec/OpenVPN/PPTP/L2TP/GRE tunnel, the interface just like "IPSec #1"
Data Model	ACS Cloud Data Model is selected by default.	Select the TR-069 dat model for the remote management. Standard : the ACS Server is a standard one, which is fully comply with TR-069. ACS Cloud Data Model : Select this data model if you intend to use Cloud ACS Server to managing the deployed gateways.
ACS URL	A Must filled setting	You can ask ACS manager provide ACS URL and manually set
ACS Username	A Must filled setting	You can ask ACS manager provide ACS username and manually set
ACS Password	A Must filled setting	You can ask ACS manager provide ACS password and manually set
ConnectionRequest Port	1. A Must filled setting. 2. By default 8099 is set.	You can ask ACS manager provide ACS ConnectionRequest Port and manually set <i>Value Range</i> : 0 ~ 65535.
ConnectionRequest UserName	A Must filled setting	You can ask ACS manager provide ACS ConnectionRequest Username and manually set
ConnectionRequest Password	A Must filled setting	You can ask ACS manager provide ACS ConnectionRequest Password and manually set
Inform	1. The box is checked by default. 2. The Interval value is 300 by default.	When the Enable box is checked, the gateway (CPE) will periodically send inform message to ACS Server according to the Interval setting. <i>Value Range</i> : 0 ~ 86400 for Inform Interval.
Certification Setup	The default box is selected by default	You can leave it as default or select an expected certificate and key from the drop down list. Refer to Object Definition > Certificate Section for the Certificate configuration.
Save	N/A	Click Save to save the settings.
Undo	N/A	Click Undo to cancel the modifications.

When you finish set **ACS URL ACS Username ACS Password**, your gateway (CPE, Client Premium Equipment) can send inform to ACS Server.

When you finish set **ConnectionRequest Port ConnectionRequest Username ConnectionRequest Password**, ACS Server can ask the gateway (CPE) to send inform to ACS Server.

Enable STUN Server

4G Vehicle Gateway

STUN Settings	
Item	Setting
▶ STUN	<input checked="" type="checkbox"/> Enable
▶ Server Address	<input type="text"/>
▶ Server Port	<input type="text" value="3478"/> (1~65535)
▶ Keep Alive Period	<input type="text" value="0"/> (0~65535)second(s)

STUN Settings Configuration		
Item	Value setting	Description
STUN	The box is checked by default	Check the Enable box to activate STUN function.
Server Address	1. String format: any IPv4 address 2. It is an optional item.	Specify the IP address for the expected STUN Server.
Server Port	1. An optional setting 2. 3478 is set by default	Specify the port number for the expected STUN Server. <i>Value Range:</i> 1 ~ 65535.
Keep Alive Period	1. An optional setting 2. 0 is set by default	Specify the keep alive time period for the connection with STUN Server. <i>Value Range:</i> 0 ~ 65535.
Save	N/A	Click Save to save the settings.
Undo	N/A	Click Undo to cancel the modifications.

4G Vehicle Gateway

6.1.3 SNMP

In brief, SNMP, the Simple Network Management Protocol, is a protocol designed to give a user the capability to remotely manage a computer network by polling and setting terminal values and monitoring network events.

In typical SNMP uses, one or more administrative computers, called managers, have the task of monitoring or managing a group of hosts or devices on a computer network. Each managed system executes, at all times, a software component called an agent which reports information via SNMP to the manager.

SNMP agents expose management data on the managed systems as variables. The protocol also permits active management tasks, such as modifying and applying a new configuration through remote modification of these variables. The variables accessible via SNMP are organized in hierarchies. These hierarchies, and other metadata (such as type and description of the variable), are described by Management Information Bases (MIBs).

The device supports several public MIBs and one private MIB for the SNMP agent. The supported MIBs are as follow: MIB-II (RFC 1213, Include IPv6), IF-MIB, IP-MIB, TCP-MIB, UDP-MIB, SMiv1 and SMiv2, SNMPv2-TM and SNMPv2-MIB, and AMIB (a Proprietary MIB)

SNMP Management Scenario

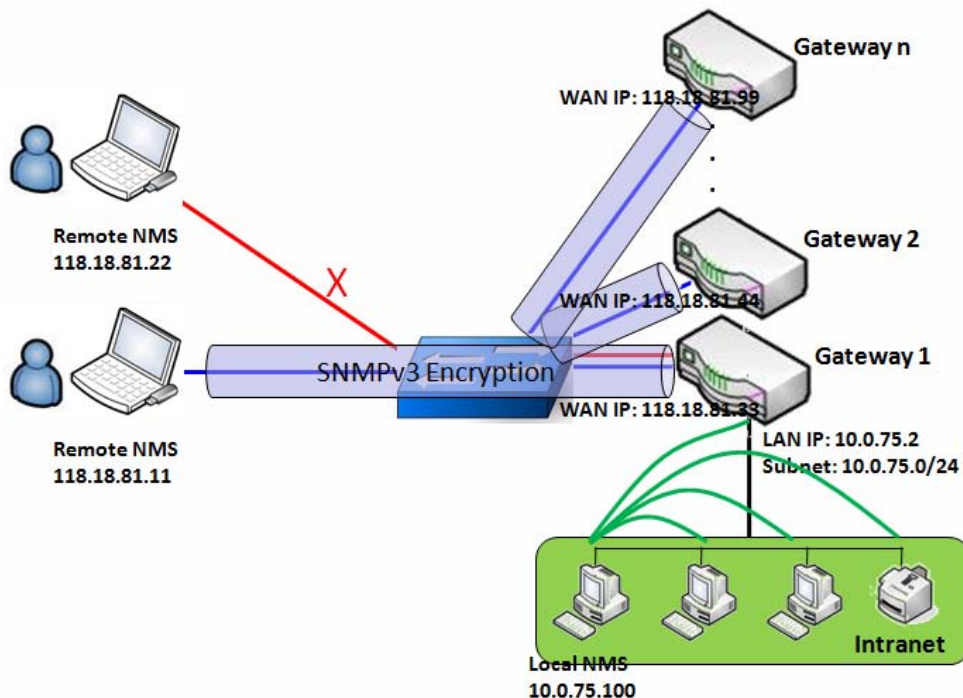

Scenario Application Timing

There are two application scenarios of SNMP Network Management Systems (NMS). Local NMS is in

4G Vehicle Gateway

the Intranet and manage all devices that support SNMP protocol in the Intranet. Another one is the Remote NMS to manage some devices whose WAN interfaces are connected together by using a switch or a router with UDP forwarding. If you want to manage some devices and they all have supported SNMP protocol, use either one application scenario, especially the management of devices in the Intranet. In managing devices in the Internet, the TR-069 is the better solution. Please refer to last sub-section.

Scenario Description

The NMS server can monitor and configure the managed devices by using SNMP protocol, and those devices are located at where UDP packets can reach from NMS.

The managed devices report urgent trap events to the NMS servers.

Use SNMPv3 version of protocol can protected the transmitting of SNMP commands and responses.

The remote NMS with privilege IP address can manage the devices, but other remote NMS can't.

Parameter Setup Example

Following tables list the parameter configuration as an example for the Gateway 1 in above diagram with "SNMP" enabling at LAN and WAN interfaces.

Use default value for those parameters that are not mentioned in the tables.

Configuration Path	[SNMP]-[Configuration]
SNMP Enable	■ LAN ■ WAN
Supported Versions	■ v1 ■ v2c ■ v3
Get / Set Community	ReadCommunity / WriteCommunity
Trap Event Receiver 1	118.18.81.11
WAN Access IP Address	118.18.81.11

Configuration Path	[SNMP]-[User Privacy Definition]		
ID	1	2	3
User Name	UserName1	UserName2	UserName3
Password	Password1	Password2	Disable
Authentication	MD5	SHA-1	Disable
Encryption	DES	Disable	Disable
Privacy Mode	authPriv	authNoPriv	noAuthNoPriv
Privacy Key	12345678	Disable	Disable
Authority	Read/Write	Read	Read
Enable	■ Enable	■ Enable	■ Enable

Scenario Operation Procedure

In above diagram, the NMS server can manage multiple devices in the Intranet or a UDP-reachable network. The "Gateway 1" is one of the managed devices, and it has the IP address of 10.0.75.2 for

4G Vehicle Gateway

LAN interface and 118.18.81.33 for WAN-1 interface. It serves as a NAT router.

At first stage, the NMS manager prepares related information for all managed devices and records them in the NMS system. Then NMS system gets the status of all managed devices by using SNMP get commands.

When the manager wants to configure the managed devices, the NMS system allows him to do that by using SNMP set commands. The "UserName1" account is used if the manager uses SNMPv3 protocol for configuring the "Gateway 1". Only the "UserName1" account can let the "Gateway 1" accept the configuration from the NMS since the authority of the account is "Read/Write".

Once a managed device has an urgent event to send, the device will issue a trap to the Trap Event Receivers. The NMS itself could be one among them.

If you want to secure the transmitted SNMP commands and responses between the NMS and the managed devices, use SNMPv3 version of protocol.

The remote NMS without privilege IP address can't manage the "Gateway 1", since "Gateway 1" allows only the NMS with privilege IP address can manage it via its WAN interface.

4G Vehicle Gateway

SNMP Setting

Go to **Administration > Configure & Manage > SNMP** tab.

The SNMP allows user to configure SNMP relevant setting which includes interface, version, access control and trap receiver.

Enable SNMP

Item	Setting																				
▶ SNMP Enable	<input checked="" type="checkbox"/> LAN <input type="checkbox"/> WAN																				
▶ WAN Interface	All WANs ▾																				
▶ Supported Versions	<input checked="" type="checkbox"/> v1 <input checked="" type="checkbox"/> v2c <input type="checkbox"/> v3																				
▶ SNMP Port	161																				
▶ Limited Remote Access IP	IP Range ▾ <table border="0"> <tr> <td><input type="text"/></td> <td>-</td> <td><input type="text"/></td> <td><input type="checkbox"/> Enable</td> </tr> <tr> <td><input type="text"/></td> <td>-</td> <td><input type="text"/></td> <td><input type="checkbox"/> Enable</td> </tr> <tr> <td><input type="text"/></td> <td>-</td> <td><input type="text"/></td> <td><input type="checkbox"/> Enable</td> </tr> <tr> <td><input type="text"/></td> <td>-</td> <td><input type="text"/></td> <td><input type="checkbox"/> Enable</td> </tr> <tr> <td><input type="text"/></td> <td>-</td> <td><input type="text"/></td> <td><input type="checkbox"/> Enable</td> </tr> </table>	<input type="text"/>	-	<input type="text"/>	<input type="checkbox"/> Enable	<input type="text"/>	-	<input type="text"/>	<input type="checkbox"/> Enable	<input type="text"/>	-	<input type="text"/>	<input type="checkbox"/> Enable	<input type="text"/>	-	<input type="text"/>	<input type="checkbox"/> Enable	<input type="text"/>	-	<input type="text"/>	<input type="checkbox"/> Enable
<input type="text"/>	-	<input type="text"/>	<input type="checkbox"/> Enable																		
<input type="text"/>	-	<input type="text"/>	<input type="checkbox"/> Enable																		
<input type="text"/>	-	<input type="text"/>	<input type="checkbox"/> Enable																		
<input type="text"/>	-	<input type="text"/>	<input type="checkbox"/> Enable																		
<input type="text"/>	-	<input type="text"/>	<input type="checkbox"/> Enable																		

SNMP Item	Value setting	Description
SNMP Enable	1.The boxes are unchecked by default	Select the interface for the SNMP and enable SNMP functions. When Check the LAN box, it will activate SNMP functions and you can access SNMP from LAN side; When Check the WAN box, it will activate SNMP functions and you can access SNMP from WAN side.
WAN Interface	1.A Must filled setting 2. ALL WANs is selected by default	Specify the WAN interface that a remote SNMP host can access to the device. By default, All WANs is selected, and there is no limitation for the WAN interface.
Supported Versions	1.A Must filled setting 2.The boxes are unchecked by default	Select the version for the SNMP When Check the v1 box. It means you can access SNMP by version 1. When Check the v2c box. It means you can access SNMP by version 2c. When Check the v3 box. It means you can access SNMP by version 3.
SNMP Port	1. String format: any	Specify the SNMP Port .

4G Vehicle Gateway

	port number 2. The default SNMP port is 161 . 3. A Must filled setting	You can fill in any port number. But you must ensure the port number is not to be used. <u>Value Range: 1 ~ 65535.</u>
Limited Remote Access IP	1. String format: any IPv4 address 2. It is an optional item.	Specify the Remote Access IP for WAN and check the box to enable it as well. Select Specific IP Address , and fill in a certain IP address. It means only this IP address can access SNMP from LAN/WAN side. Select IP Range , and fill in a range of IP addresses. It means the IP address within specified range can access SNMP from LAN/WAN side. If you left it as blank, it means any IP address can access SNMP from WAN side.
Save	N/A	Click Save to save the settings
Undo	N/A	Click Undo to cancel the settings

Create/Edit Multiple Community

The SNMP allows you to custom your access control for version 1 and version 2 user. The router supports up to a maximum of 10 community sets.

ID	Community	Enable	Actions
----	-----------	--------	---------

When **Add** button is applied, **Multiple Community Rule Configuration** screen will appear.

Item	Setting
Community	Read Only ▾ <input type="text"/>
Enable	<input checked="" type="checkbox"/> Enable

Multiple Community Rule Configuration		
Item	Value setting	Description
Community	1. Read Only is selected by default 2. A Must filled setting 3. String format: any text	Specify this version 1 or version v2c user's community that will be allowed Read Only (GET and GETNEXT) or Read-Write (GET, GETNEXT and SET) access respectively. The maximum length of the community is 32.
Enable	1.The box is checked by default	Click Enable to enable this version 1 or version v2c user.
Save	N/A	Click the Save button to save the configuration. But it does not apply to SNMP functions. When you return to the SNMP main page. It will show "Click on save button to apply your changes" remind user to click main page Save button.

4G Vehicle Gateway

Undo	N/A	Click the Undo button to cancel the settings.
Back	N/A	Click the Back button to return to last page.

Create/Edit User Privacy

The SNMP allows you to custom your access control for version 3 user. The router supports up to a maximum of 128 User Privacy sets.

User Privacy List										
ID	User Name	Password	Authentication	Encryption	Privacy Mode	Privacy Key	Authority	OID Filter Prefix	Enable	Actions

When **Add** button is applied, **User Privacy Rule Configuration** screen will appear.

User Privacy Rule Configuration	
Item	Setting
▶ User Name	<input type="text"/>
▶ Password	<input type="password"/>
▶ Authentication	None ▼
▶ Encryption	None ▼
▶ Privacy Mode	noAuthNoPriv ▼
▶ Privacy Key	<input type="password"/>
▶ Authority	Read ▼
▶ OID Filter Prefix	<input type="text" value="1"/>
▶ Enable	<input checked="" type="checkbox"/> Enable

User Privacy Rule Configuration		
Item	Value setting	Description
User Name	1. A Must filled setting 2. String format: any text	Specify the User Name for this version 3 user. Value Range: 1 ~ 32 characters.
Password	1. String format: any text	When your Privacy Mode is authNoPriv or authPriv , you must specify the Password for this version 3 user. Value Range: 8 ~ 64 characters.
Authentication	1. None is selected by default	When your Privacy Mode is authNoPriv or authPriv , you must specify the Authentication types for this version 3 user. Selected the authentication types MD5/ SHA-1 to use.
Encryption	1. None is selected by default	When your Privacy Mode is authPriv , you must specify the Encryption protocols for this version 3 user.

4G Vehicle Gateway

		Selected the encryption protocols DES / AES to use.
Privacy Mode	1. noAuthNoPriv is selected by default	Specify the Privacy Mode for this version 3 user. Selected the noAuthNoPriv . You do not use any authentication types and encryption protocols. Selected the authNoPriv . You must specify the Authentication and Password . Selected the authPriv . You must specify the Authentication, Password, Encryption and Privacy Key.
Privacy Key	1. String format: any text	When your Privacy Mode is authPriv , you must specify the Privacy Key (8 ~ 64 characters) for this version 3 user.
Authority	1. Read is selected by default	Specify this version 3 user's Authority that will be allowed Read Only (GET and GETNEXT) or Read-Write (GET, GETNEXT and SET) access respectively.
OID Filter Prefix	1. The default value is 1 2. A Must filled setting 3. String format: any legal OID	The OID Filter Prefix restricts access for this version 3 user to the sub-tree rooted at the given OID. Value Range: 1 ~2080768.
Enable	1.The box is checked by default	Click Enable to enable this version 3 user.
Save	N/A	Click the Save button to save the configuration. But it does not apply to SNMP functions. When you return to the SNMP main page. It will show "Click on save button to apply your changes" remind user to click main page Save button.
Undo	N/A	Click the Undo button to cancel the settings
Back	N/A	Click the X button to return the last page.

Create/Edit Trap Event Receiver

The SNMP allows you to custom your trap event receiver. The router supports up to a maximum of 4 Trap Event Receiver sets.

Trap Event Receiver List												
ID	Server IP	Server Port	SNMP Version	Community Name	User Name	Password	Privacy Mode	Authentication	Encryption	Privacy Key	Enable	Actions

When **Add** button is applied, **Trap Event Receiver Rule Configuration** screen will appear. The default SNMP Version is v1. The configuration screen will provide the version 1 must filled items.

4G Vehicle Gateway

Trap Event Receiver Rule Configuration	
Item	Setting
▶ Server IP	<input type="text"/> (IP Address/FQDN)
▶ Server Port	<input type="text" value="162"/>
▶ SNMP Version	<input type="text" value="v1"/>
▶ Community Name	<input type="text"/>
▶ Enable	<input checked="" type="checkbox"/> Enable

When you selected v2c, the configuration screen is exactly the same as that of v1, except the version.

When you selected v3, the configuration screen will provide more setting items for the version 3 Trap.

Trap Event Receiver Rule Configuration	
Item	Setting
▶ Server IP	<input type="text"/> (IP Address/FQDN)
▶ Server Port	<input type="text" value="162"/>
▶ SNMP Version	<input type="text" value="v3"/>
▶ Community Name	<input type="text"/>
▶ User Name	<input type="text"/>
▶ Password	<input type="text"/>
▶ Privacy Mode	<input type="text" value="noAuthNoPriv"/>
▶ Authentication	<input type="text" value="None"/>
▶ Encryption	<input type="text" value="None"/>
▶ Privacy Key	<input type="text"/>
▶ Enable	<input checked="" type="checkbox"/> Enable

Trap Event Receiver Rule Configuration		
Item	Value setting	Description
Server IP	<ol style="list-style-type: none"> 1. A Must filled setting 2. String format: any IPv4 address or FQDN 	Specify the trap Server IP or FQDN . The DUT will send trap to the server IP/FQDN.
Server Port	<ol style="list-style-type: none"> 1. String format: any port number 2. The default SNMP trap port is 162 3. A Must filled setting 	Specify the trap Server Port . You can fill in any port number. But you must ensure the port number is not to be used. <i>Value Range: 1 ~ 65535.</i>
SNMP Version	<ol style="list-style-type: none"> 1. v1 is selected by 	Select the version for the trap

4G Vehicle Gateway

	default	<p>Selected the v1. The configuration screen will provide the version 1 must filled items.</p> <p>Selected the v2c. The configuration screen will provide the version 2c must filled items.</p> <p>Selected the v3. The configuration screen will provide the version 3 must filled items.</p>
Community Name	<p>1. A v1 and v2c Must filled setting</p> <p>2. String format: any text</p>	<p>Specify the Community Name for this version 1 or version v2c trap.</p> <p>Value Range: 1 ~ 32 characters.</p>
User Name	<p>1. A v3 Must filled setting</p> <p>2. String format: any text</p>	<p>Specify the User Name for this version 3 trap.</p> <p>Value Range: 1 ~ 32 characters.</p>
Password	<p>1. A v3 Must filled setting</p> <p>2. String format: any text</p>	<p>When your Privacy Mode is authNoPriv or authPriv, you must specify the Password for this version 3 trap.</p> <p>Value Range: 8 ~ 64 characters.</p>
Privacy Mode	<p>1. A v3 Must filled setting</p> <p>2. noAuthNoPriv is selected by default</p>	<p>Specify the Privacy Mode for this version 3 trap.</p> <p>Selected the noAuthNoPriv. You do not use any authentication types and encryption protocols.</p> <p>Selected the authNoPriv. You must specify the Authentication and Password.</p> <p>Selected the authPriv. You must specify the Authentication, Password, Encryption and Privacy Key.</p>
Authentication	<p>1. A v3 Must filled setting</p> <p>2. None is selected by default</p>	<p>When your Privacy Mode is authNoPriv or authPriv, you must specify the Authentication types for this version 3 trap.</p> <p>Selected the authentication types MD5/ SHA-1 to use.</p>
Encryption	<p>1. A v3 Must filled setting</p> <p>2. None is selected by default</p>	<p>When your Privacy Mode is authPriv, you must specify the Encryption protocols for this version 3 trap.</p> <p>Selected the encryption protocols DES / AES to use.</p>
Privacy Key	<p>1. A v3 Must filled setting</p> <p>2. String format: any text</p>	<p>When your Privacy Mode is authPriv, you must specify the Privacy Key (8 ~ 64 characters) for this version 3 trap.</p>
Enable	<p>1. The box is checked by default</p>	<p>Click Enable to enable this trap receiver.</p>
Save	N/A	<p>Click the Save button to save the configuration. But it does not apply to SNMP functions. When you return to the SNMP main page. It will show "Click on save button to apply your changes" remind user to click main page Save button.</p>
Undo	N/A	<p>Click the Undo button to cancel the settings.</p>
Back	N/A	<p>Click the X button to return to last page.</p>

4G Vehicle Gateway

Specify SNMP MIB-2 System

If required, you can also specify the required information for the MIB-2 System.

SNMP MIB-2 System	
Item	Setting
▶ sysContact	<input type="text"/>
▶ sysLocation	<input type="text"/>

SNMP MIB-2 System Configuration		
Item	Value setting	Description
sysContact	1. An Optional filled setting 2. String format: any text	Specify the contact information for MIB-2 system. Value Range: 0 ~ 64 characters.
sysLocation	1. An Optional filled setting 2. String format: any text	Specify the location information for MIB-2 system. Value Range: 0 ~ 64 characters.

Edit SNMP Options

If you use some particular private MIB, you must fill the enterprise name, number and OID.

Options	
Item	Setting
▶ Enterprise Name	<input type="text" value="Default"/>
▶ Enterprise Number	<input type="text" value="12823"/>
▶ Enterprise OID	1.3.6.1.4.1. <input type="text" value="12823.4.4.9"/>

Options		
Item	Value setting	Description
Enterprise Name	1. The default value is Default 2. A Must filled setting 3. String format: any text	Specify the Enterprise Name for the particular private MIB. Value Range: 1 ~ 10 characters, and only string with A~Z, a~z, 0~9, '-', '_'. Value Range: 1 ~ 2080768.
Enterprise Number	The default value is 12823 (Default Enterprise	Specify the Enterprise Number for the particular private MIB. Value Range: 1 ~ 2080768.

4G Vehicle Gateway

	<p>Number)</p> <p>2. A Must filled setting</p> <p>3. String format: any number</p>	
Enterprise OID	<p>1. The default value is 1.3.6.1.4.1.12823.4.4.9 (Default Enterprise OID)</p> <p>2. A Must filled setting</p> <p>3. String format: any legal OID</p>	<p>Specify the Enterprise OID for the particular private MIB.</p> <p>The range of the each OID number is 1-2080768.</p> <p>The maximum length of the enterprise OID is 31.</p> <p>The seventh number must be identical with the enterprise number.</p>
Save	N/A	Click the Save button to save the configuration and apply your changes to SNMP functions.
Undo	N/A	Click the Undo button to cancel the settings.

4G Vehicle Gateway

6.1.4 Telnet & SSH

A command-line interface (CLI), also known as command-line user interface, and console user interface are means of interacting with a computer program where the user (or client) issues commands to the program in the form of successive lines of text (command lines). The interface is usually implemented with a command line shell, which is a program that accepts commands as text input and converts commands to appropriate operating system functions. Programs with command-line interfaces are generally easier to automate via scripting. The device supports both Telnet and SSH (Secure Shell) CLI with default service port 23 and 22, respectively.

Telnet & SSH Scenario

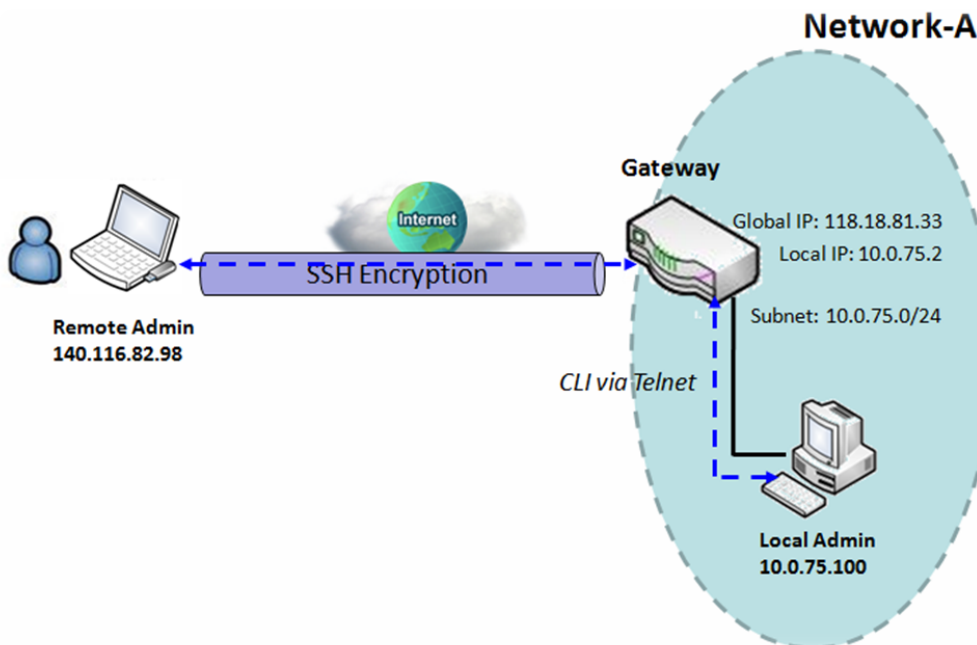

Scenario Application Timing

When the administrator of the gateway wants to manage it from remote site in the Intranet or Internet, he may use "Telnet with CLI" function to do that by using "Telnet" or "SSH" utility.

Scenario Description

The Local Admin or the Remote Admin can manage the Gateway by using "Telnet" or "SSH" utility with privileged user name and password.

The data packets between the Local Admin and the Gateway or between the Remote Admin and the Gateway can be plain texts or encrypted texts. Suggest they are plain texts in the Intranet for Local Admin to use "Telnet" utility, and encrypted texts in the Internet for Remote Admin to use "SSH"

4G Vehicle Gateway

utility.

Parameter Setup Example

Following table lists the parameter configuration as an example for the Gateway in above diagram with "Telnet with CLI" enabling at LAN and WAN interfaces.

Use default value for those parameters that are not mentioned in the table.

Configuration Path	[Telnet & SSH]-[Configuration]
Telnet	LAN: <input checked="" type="checkbox"/> <i>Enable</i> WAN: <input type="checkbox"/> <i>Enable</i> Service Port: 23
SSH	LAN: <input checked="" type="checkbox"/> <i>Enable</i> WAN: <input checked="" type="checkbox"/> <i>Enable</i> Service Port: 22

Scenario Operation Procedure

In above diagram, "Local Admin" or "Remote Admin" can manage the "Gateway" in the Intranet or Internet. The "Gateway" is the gateway of Network-A, and the subnet of its Intranet is 10.0.75.0/24. It has the IP address of 10.0.75.2 for LAN interface and 118.18.81.33 for WAN-1 interface. It serves as a NAT gateway.

The "Local Admin" in the Intranet uses "Telnet" utility with privileged account to login the Gateway.

Or the "Remote Admin" in the Internet uses "SSH" utility with privileged account to login the Gateway.

The administrator of the gateway can control the device as like he is in front of the gateway.

4G Vehicle Gateway

Telnet & SSH Setting

Go to Administration > Configure & Manage > Telnet & SSH tab.

The Telnet & SSH setting allows administrator to access this device through the traditional Telnet or SSH Telnet program. Before you can telnet (login) to the device, please configure the related settings with care.

Item	Setting
Telnet	LAN <input checked="" type="checkbox"/> Enable WAN <input type="checkbox"/> Enable (WAN-1 <input checked="" type="checkbox"/> WAN-4 <input type="checkbox"/>) <input type="text"/> Service Port <input type="text" value="23"/>
SSH	LAN <input checked="" type="checkbox"/> Enable WAN <input type="checkbox"/> Enable (WAN-1 <input checked="" type="checkbox"/> WAN-4 <input type="checkbox"/>) <input type="text"/> Service Port <input type="text" value="22"/>

Configuration		
Item	Value setting	Description
Telnet	1. The LAN Enable box is checked by default. 2. By default Service Port is 23.	Check the Enable box to activate the Telnet function for connecting from LAN or WAN interfaces. You can set which number of Service Port you want to provide for the corresponding service. Value Range: 1 ~65535.
SSH	3. The LAN Enable box is checked by default. 4. By default Service Port is 22.	Check the Enable box to activate the SSH Telnet function for connecting from LAN or WAN interfaces. You can set which number of Service Port you want to provide for the corresponding service. Value Range: 1 ~65535.
Save	N/A	Click Save to save the settings
Undo	N/A	Click Undo to cancel the settings

Note: The Telnet/SSH login password is the same one as the administrator's login password for the device web GUI.

4G Vehicle Gateway

6.2 System Operation

System Operation allows the network administrator to manage system, settings such as web-based utility access password change, system information, system time, system log, firmware/configuration backup & restore, and reset & reboot.

6.2.1 Password & MMI

Go to **Administration > System Operation > Password & MMI** tab.

Setup Host Name

Host Name screen allows network administrator to setup / change the host name of the gateway. Click the **Modify** button and provide the new username setting.

Item	Setting
▶ Host Name	<input type="text"/>

Username Configuration		
Item	Value setting	Description
Host Name	1. An Optional setting 2. It is blanked by default	Enter the host name of the gateway.
Save	N/A	Click Save button to save the settings
Undo	N/A	Click Undo button to cancel the settings

Change UserName

Username screen allows network administrator to change the web-based MMI login account to access gateway. Click the **Modify** button and provide the new username setting.

Item	Setting
▶ Username	admin <input type="button" value="Modify"/>
▶ New Username	<input type="text"/>
▶ Password	<input type="text"/>

4G Vehicle Gateway

Username Configuration		
Item	Value setting	Description
Username	1. The default Username for web-based MMI is 'admin'.	Display the current MMI login account (Username).
New Username	String: any text	Enter new Username to replace the current setting.
Password	String: any text	Enter current password to verify if you have the permission to change the username setting.
Save	N/A	Click Save button to save the settings
Undo	N/A	Click Undo button to cancel the settings

Change Password

Change password screen allows network administrator to change the web-based MMI login password to access gateway.

Password

Item	Setting
▶ Old Password	<input type="text"/>
▶ New Password	<input type="text"/>
▶ New Password Confirmation	<input type="text"/>

Password Configuration		
Item	Value setting	Description
Old Password	1. String: any text 2. The default password for web-based MMI is 'admin'.	Enter the current password to enable you unlock to change password.
New Password	String: any text	Enter new password
New Password Confirmation	String: any text	Enter new password again to confirm
Save	N/A	Click Save button to save the settings
Undo	N/A	Click Undo button to cancel the settings

Change MMI Setting for Accessing

This is the gateway's web-based MMI access which allows administrator to access the gateway for management. The gateway's web-based MMI will automatically logout when the idle time has elapsed. The

4G Vehicle Gateway

setting allows administrator to enable automatic logout and set the logout idle time. When the login timeout is disabled, the system won't logout the administrator automatically.

Item	Setting
▶ Login	Password-Guessing Attack & MAX: <input type="text" value="3"/> (times)
▶ Login Timeout	<input checked="" type="checkbox"/> Enable <input type="text" value="300"/> (seconds)
▶ GUI Access Protocol	<input type="text" value="http/https"/>
▶ HTTPs Certificate Setup	<input checked="" type="radio"/> default <input type="radio"/> Select from Certificate List Certificate: <input type="text" value="TrustedCert0"/> Key: <input type="text" value="TrustedKey0"/>
▶ HTTP Compression	<input checked="" type="checkbox"/> gzip <input type="checkbox"/> deflate
▶ HTTP Binding	<input checked="" type="checkbox"/> DHCP 1
▶ System Boot Mode	<input type="text" value="Normal Mode"/>

MMI Configuration		
Item	Value setting	Description
Login	3 times is set by default	Enter the login trial counting value. Value Range: 3 ~ 10. If someone tried to login the web GUI with incorrect password for more than the counting value, an warning message " Already reaching maximum Password-Guessing times, please wait a few seconds! " will be displayed and ignore the following login trials.
Login Timeout	The Enable box is checked, and 300 is set by default.	Check the Enable box to activate the auto logout function, and specify the maximum idle time as well. Value Range: 30 ~ 65535.
GUI Access Protocol	http/https is selected by default.	Select the protocol that will be used for GUI access. It can be http/https , http only , or https only .
HTTPs Certificate Setup	The default box is selected by default	If the https Access Protocol is selected, the HTTPs Certificate Setup option will be available for further configuration. You can leave it as default or select a expected certificate and key from the drop down list. Refer to Object Definition > Certificate Section for the Certificate configuration.
HTTP Compression	The box is unchecked by default.	Check the box (gzip , or deflate) if any compression method is preferred.
HTTP Binding	1. An Optional setting 2. DHCP-1 is checked by default	Select the DHCP Server to bind with http access.
System Boot Mode	Normal Mode is selected	Select the system boot mode that will be adopted to boot up the device.

4G Vehicle Gateway

by default.

Normal Mode: It takes longer boot up time, with complete firmware image check during the device booting.

Fast Mode: It takes shorter boot up time, without checking the firmware image during the device booting.

Quick Mode: It takes the shortest boot up time, without checking the firmware image and creating the internal database for User/Group/Captive Portal functions.

Note: Use **Quick Mode** with care, once selected, the User/Group/Captive Portal function will become non-functional.

Save	N/A	Click Save button to save the settings
Undo	N/A	Click Undo button to cancel the settings

4G Vehicle Gateway

6.2.2 System Information

System Information screen gives network administrator a quick look up on the device information for the purchased gateway.

Go to **Administration > System Operation > System Information** tab.

System Information	
Item	Setting
▶ Model Name	VHG87BAM_0T001
▶ Device Serial Number	
▶ Kernel Version	2.6.36
▶ FW Version	0000Y90.J31_e32.BETA_04021700
▶ System Time	Thu, 18 Apr 2019 16:18:16 +0800
▶ Device Up-Time	15day 22hr 30min 35sec

System Information		
Item	Value Setting	Description
Model Name	N/A	It displays the model name of this product.
Device Serial Number	N/A	It displays the serial number of this product.
Kernel Version	N/A	It displays the Linux kernel version of the product
FW Version	N/A	It displays the firmware version of the product
Memory Usage	N/A	It displays the percentage of device memory utilization.
System Time	N/A	It displays the current system time that you browsed this web page.
Device Up-Time	N/A	It displays the statistics for the device up-time since last boot up.
Refresh	N/A	Click the Refresh button to update the system Information immediately.

4G Vehicle Gateway

6.2.3 System Time

The gateway provides manually setup and auto-synchronized approaches for the administrator to setup the system time for the gateway. The time supported synchronization methods can be Time Server, Manual, PC, Cellular Module, or GPS Signal. Select the method first, and then configure rest settings.

Instead of manually configuring the system time for the gateway, there are two simple and quick solutions for you to set the correct time information and set it as the system time for the gateway.

The first one is “Sync with Timer Server”. Based on your selection of time zone and time server in above time information configuration window, system will communicate with time server by NTP Protocol to get system date and time after you click on the **Synchronize immediately** button.

The second one is “Sync with my PC”. Select the method and the system will synchronize its date and time to the time of the administration PC.

Go to **Administration > System Operation > System Time** tab.

Synchronize with Time Server

Item	Setting
▶ Synchronization method	Time Server ▾
▶ Time Zone	(GMT+00:00) Greenwich Mean Time: Dublin, Edinburgh, Lisbon, London ▾
▶ Auto-synchronization	Time Server: <input type="text"/> Available Time Servers (RFC-868): Auto ▾
▶ Daylight Saving Time	<input type="checkbox"/> Enable
▶ NTP Service	<input type="checkbox"/> Enable
▶ Synchronize immediately	Active

System Time Information		
Item	Value Setting	Description
Synchronization method	1. A Must-filled item. 2. Time Server is selected by default.	Select the Time Server as the synchronization method for the system time.
Time Zone	1. A GMT+00 :00 item. 2. GMT+00 :00 is selected by default.	Select a time zone where this device locates.
Auto-synchronization	1. A Must-filled item. 2. Auto is selected by	Enter the IP or FQDN for the NTP time server you expected, or leave it as auto mode so that the available server will be used for time synchronization one by

4G Vehicle Gateway

	default.	one.
Daylight Saving Time	<ol style="list-style-type: none"> 1. It is an optional item. 2. Un-checked by default 	Check the Enable button to activate the daylight saving function. When you enabled this function, you have to specify the start date and end date for the daylight saving time duration.
NTP Service	<ol style="list-style-type: none"> 1. It is an optional item. 2. Un-checked by default 	Check the Enable button to activate the NTP Service function. When you enabled this function, the gateway can provide NTP server service for its local connected devices.
Synchronize immediately	N/A	Click the Active button to synchronize the system time with specified time server immediately.
Save	N/A	Click the Save button to save the settings.
Refresh	N/A	Click the Refresh button to update the system time immediately.

Note: Remember to select a correct time zone for the device, otherwise, you will just get the UTC (Coordinated Universal Time) time, not the local time for the device.

Synchronize with Manually Setting

System Time Configuration
⏪ ⏩ ✕

Item	Setting
▶ Synchronization method	Manual ▼
▶ Time Zone	(GMT+00:00) Greenwich Mean Time: Dublin, Edinburgh, Lisbon, London ▼
▶ Daylight Saving Time	<input type="checkbox"/> Enable
▶ Set Date & Time Manually	2019 ▼ / April ▼ / 18 ▼ (Year/Month/Day)
	16 ▼ : 24 ▼ : 27 ▼ (Hour:Minute:Second)
▶ NTP Service	<input type="checkbox"/> Enable:

System Time Information		
Item	Value Setting	Description
Synchronization method	<ol style="list-style-type: none"> 1. A Must-filled item. 2. Time Server is selected by default. 	Select the Manual as the synchronization method for the system time. It means administrator has to set the Date & Time manually.
Time Zone	<ol style="list-style-type: none"> 1. A Must-filled item. 2. GMT+00 :00 is selected by default. 	Select a time zone where this device locates.
Daylight Saving Time	<ol style="list-style-type: none"> 1. It is an optional item. 2. Un-checked by default 	Check the Enable button to activate the daylight saving function. When you enabled this function, you have to specify the start date and end date for the daylight saving time duration.
Set Date & Time Manually	<ol style="list-style-type: none"> 1. It is an optional item. 	Manually set the date (Year/Month/Day) and time (Hour:Minute:Second) as the system time.
NTP Service	<ol style="list-style-type: none"> 1. It is an optional item. 	Check the Enable button to activate the NTP Service function.

4G Vehicle Gateway

	2. Un-checked by default	When you enabled this function, the gateway can provide NTP server service for its local connected devices.
Save	N/A	Click the Save button to save the settings.

Synchronize with PC

System Time Configuration
⏪ ⏩ ✕

Item	Setting
▶ Synchronization method	PC ▾
▶ NTP Service	<input type="checkbox"/> Enable
▶ Synchronize immediately	Active

System Time Information		
Item	Value Setting	Description
Synchronization method	1. A Must-filled item. 2. Time Server is selected by default.	Select PC as the synchronization method for the system time to let system synchronize its date and time to the time of the administration PC.
NTP Service	1. It is an optional item. 2. Un-checked by default	Check the Enable button to activate the NTP Service function. When you enabled this function, the gateway can provide NTP server service for its local connected devices.
Synchronize immediately	N/A	Click the Active button to synchronize the system time with specified time server immediately.
Save	N/A	Click the Save button to save the settings.
Refresh	N/A	Click the Refresh button to update the system time immediately.

4G Vehicle Gateway

Synchronize with Cellular Time Service

System Time Configuration	
Item	Setting
Synchronization method	Cellular Module ▾
Time Zone	(GMT+00:00) Greenwich Mean Time: Dublin, Edinburgh, Lisbon, London ▾
NTP Service	<input type="checkbox"/> Enable
Synchronize immediately	Active

System Time Information		
Item	Value Setting	Description
Synchronization method	<ol style="list-style-type: none"> 1. A Must-filled item. 2. Time Server is selected by default. 	Select Cellular Module as the synchronization method for the system time to let system synchronize its date and time to the time provided from the connected mobile ISP. Note: this option is only available for the product with Cellular WAN interface.
Time Zone	<ol style="list-style-type: none"> 1. A Must-filled item. 2. GMT+00 :00 is selected by default. 	Select a time zone where this device locates.
NTP Service	<ol style="list-style-type: none"> 1. It is an optional item. 2. Un-checked by default 	Check the Enable button to activate the NTP Service function. When you enabled this function, the gateway can provide NTP server service for its local connected devices.
Synchronize immediately	N/A	Click the Active button to synchronize the system time with specified time server immediately.
Save	N/A	Click the Save button to save the settings.
Refresh	N/A	Click the Refresh button to update the system time immediately.

4G Vehicle Gateway

Synchronize with GPS Time Service

System Time Configuration	
Item	Setting
▶ Synchronization method	GPS Signal ▾
▶ Time Zone	(GMT+00:00) Greenwich Mean Time: Dublin, Edinburgh, Lisbon, London ▾
▶ NTP Service	<input type="checkbox"/> Enable
▶ Synchronize immediately	Active

System Time Information		
Item	Value Setting	Description
Synchronization method	<ol style="list-style-type: none"> 1. A Must-filled item. 2. Time Server is selected by default. 	Select GPS Signal as the synchronization method for the system time to let system synchronize its date and time to the time provided from the GNSS service. Note: this option is only available for the product with GNSS interface.
Time Zone	<ol style="list-style-type: none"> 1. A Must-filled item. 2. GMT+00 :00 is selected by default. 	Select a time zone where this device locates.
NTP Service	<ol style="list-style-type: none"> 1. It is an optional item. 2. Un-checked by default 	Check the Enable button to activate the NTP Service function. When you enabled this function, the gateway can provide NTP server service for its local connected devices.
Synchronize immediately	N/A	Click the Active button to synchronize the system time with specified time server immediately.
Save	N/A	Click the Save button to save the settings.
Refresh	N/A	Click the Refresh button to update the system time immediately.

4G Vehicle Gateway

6.2.4 System Log

System Log screen contains various event log tools facilitating network administrator to perform local event logging and remote reporting.

Go to **Administration > System Operation > System Log** tab.

Item	Setting
▶ Web Log Type Category	<input checked="" type="checkbox"/> System <input checked="" type="checkbox"/> Attacks <input checked="" type="checkbox"/> Drop <input checked="" type="checkbox"/> Login message <input type="checkbox"/> Debug
▶ Email Alert	<input type="checkbox"/> Enable Server: --- Option --- <input type="button" value="Add Object"/> E-mail Addresses: <input type="text"/> Subject: <input type="text"/> Log type Category: <input type="checkbox"/> System <input type="checkbox"/> Attacks <input type="checkbox"/> Drop <input type="checkbox"/> Login message <input type="checkbox"/> Debug
▶ Syslog	<input type="checkbox"/> Enable Server: --- Option --- <input type="button" value="Add Object"/> Log type Category: <input type="checkbox"/> System <input type="checkbox"/> Attacks <input type="checkbox"/> Drop <input type="checkbox"/> Login message <input type="checkbox"/> Debug
▶ Log to Storage	<input checked="" type="checkbox"/> Enable Select Device: Internal ▾ Log file name: <input type="text" value="syslog"/> Split file: <input type="checkbox"/> Enable Size: <input type="text" value="200"/> <input type="button" value="KB ▾"/> Interval: <input type="checkbox"/> Enable <input type="text" value="1440"/> (1 ~ 10080 Minutes) Max Records: <input type="text" value="3000"/> (5~10000) <input type="button" value="Download log file"/> <input type="button" value="clear logs"/> Log type Category: <input checked="" type="checkbox"/> System <input checked="" type="checkbox"/> Attacks <input checked="" type="checkbox"/> Drop <input checked="" type="checkbox"/> Login message <input checked="" type="checkbox"/> Debug

View & Email Log History

View button is provided for network administrator to view log history on the gateway. **Email Now** button enables administrator to send instant Email for analysis.

View & Email Log History		
Item	Value setting	Description
View button	N/A	Click the View button to view Log History in Web Log List Window.
Email Now button	N/A	Click the Email Now button to send Log History via Email instantly.

4G Vehicle Gateway

Web Log List		Previous	Next	First	Last	Download	Clear
Time	Log						
Apr 1 06:01:36	dnsmasq-dhcp[6016]: Ignoring domain amit.com.tw for DHCP host name NB-msnb						
Apr 1 06:08:31	dnsmasq-dhcp[6016]: Ignoring domain amit.com.tw for DHCP host name NB-msnb						
Apr 1 06:15:30	dnsmasq-dhcp[6016]: Ignoring domain amit.com.tw for DHCP host name NB-msnb						
Apr 1 06:22:06	dnsmasq-dhcp[6016]: Ignoring domain amit.com.tw for DHCP host name NB-msnb						
Apr 1 06:28:42	dnsmasq-dhcp[6016]: Ignoring domain amit.com.tw for DHCP host name NB-msnb						
Apr 1 06:35:42	dnsmasq-dhcp[6016]: Ignoring domain amit.com.tw for DHCP host name NB-msnb						
Apr 1 06:42:20	dnsmasq-dhcp[6016]: Ignoring domain amit.com.tw for DHCP host name NB-msnb						

Web Log List Window		
Item	Value Setting	Description
Time column	N/A	It displays event time stamps
Log column	N/A	It displays Log messages

Web Log List Button Description		
Item	Value setting	Description
Previous	N/A	Click the Previous button to move to the previous page.
Next	N/A	Click the Next button to move to the next page.
First	N/A	Click the First button to jump to the first page.
Last	N/A	Click the Last button to jump to the last page.
Download	N/A	Click the Download button to download log to your PC in tar file format.
Clear	N/A	Click the Clear button to clear all log.
Back	N/A	Click the Back button to return to the previous page.

Web Log Type Category

Web Log Type Category screen allows network administrator to select the type of events to log and be displayed in the Web Log List Window as described in the previous section. Click on the View button to view Log History in the Web Log List window.

▶ Web Log Type Category	<input checked="" type="checkbox"/> System	<input checked="" type="checkbox"/> Attacks	<input checked="" type="checkbox"/> Drop	<input checked="" type="checkbox"/> Login message	<input type="checkbox"/> Debug
-------------------------	--	---	--	---	--------------------------------

Web Log Type Category Setting Window		
Item	Value Setting	Description
System	Checked by default	Check to log system events and to display in the Web Log List window.
Attacks	Checked by default	Check to log attack events and to display in the Web Log List window.
Drop	Checked by default	Check to log packet drop events and to display in the Web Log List window.
Login message	Checked by default	Check to log system login events and to display in the Web Log List window.

4G Vehicle Gateway

Debug	Un-checked by default	Check to log debug events and to display in the Web Log List window.
-------	-----------------------	--

Email Alert

Email Alert screen allows network administrator to select the type of event to log and be sent to the destined Email account.

▶ Email Alert

Enable
 Server: --- Option --- ▼ Add Object
 E-mail Addresses:
 Subject:
 Log type Category: System Attacks Drop Login message Debug

Email Alert Setting Window		
Item	Value Setting	Description
Enable	Un-checked by default	Check Enable box to enable sending event log messages to destined Email account defined in the E-mail Addresses blank space.
Server	N/A	Select one email server from the Server dropdown box to send Email. If none has been available, click the Add Object button to create an outgoing Email server. You may also add an outgoing Email server from Object Definition > External Server > External Server tab.
E-mail address	String : email format	Enter the recipient's Email address. Separate Email addresses with comma ',' or semicolon ';' Enter the Email address in the format of 'myemail@domain.com'
Subject	String : any text	Enter an Email subject that is easy for you to identify on the Email client.
Log type category	Default unchecked	Select the type of events to log and be sent to the designated Email account. Available events are System, Attacks, Drop, Login message, and Debug.

4G Vehicle Gateway

Syslogd

Syslogd screen allows network administrator to select the type of event to log and be sent to the designated Syslog server.

Syslogd
 Enable Server: --- Option --- ▾

Log type Category: System Attacks Drop Login message Debug

Syslogd Setting Window		
Item	Value Setting	Description
Enable	Un-checked by default	Check Enable box to activate the Syslogd function, and send event logs to a syslog server
Server	N/A	Select one syslog server from the Server dropdown box to sent event log to. If none has been available, click the Add Object button to create a system log server. You may also add an system log server from the Object Definition > External Server > External Server tab.
Log type category	Un-checked by default	Select the type of event to log and be sent to the destined syslog server. Available events are System, Attacks, Drop, Login message, and Debug.

Log to Storage

Log to Storage screen allows network administrator to select the type of events to log and be stored at an internal or an external storage.

Log to Storage
 Enable

Select Device: Internal ▾

Log file name:

Split file: Enable Size: KB ▾

Interval: Enable (1 ~ 10080 Minutes)

Max Records: (5~10000)

Log type Category: System Attacks Drop Login message Debug

Log to Storage Setting Window		
Item	Value Setting	Description
Enable	Un-checked by default	Check to enable sending log to storage.
Select Device	Internal is selected by default	Select internal or external storage.
Log file name	Un-checked by default	Enter log file name to save logs in designated storage.
Split file Enable	Un-checked by default	Check enable box to split file whenever log file reaching the specified limit.
Split file Size	200 KB is set by default	Enter the file size limit for each split log file. Value Range: 10 ~ 1000.
Interval Enable	Un-checked by default	Check enable box to enable the log interval setting.
Log Interval	1440 is set by default	Enter the log interval setting. Value Range: 1 ~ 10080 Minute.
Max Records	3000 is set by default	Enter the maximum number of records to be stored in the log storage. Value Range: 5 ~ 10000.
Log type category	Un-checked by default	Check which type of logs to send: System, Attacks, Drop, Login message, Debug

4G Vehicle Gateway

Log to Storage Button Description		
Item	Value setting	Description
Download log file	N/A	Click the Download log file button to download log files to a log.tar file.
Clear Logs	N/A	Click the Clear logs button to delete the log files from the storage.

4G Vehicle Gateway

6.2.5 Backup & Restore

In the Backup & Restore window, you can upgrade the device firmware when new firmware is available and also backup / restore the device configuration.

In addition to the factory default settings, you can also customize a special configuration setting as a customized default value. With this customized default value, you can reset the device to the expected default setting if needed.

Go to **Administration > System Operation > Backup & Restore** tab.

FW Backup & Restore	
Item	Setting
▶ FW Upgrade	Via Web UI ▼ FW Upgrade
▶ Backup Configuration Settings	Download ▼ Via Web UI
▶ Auto Restore Configuration	<input type="checkbox"/> Enable Save Conf. Clean Conf. Conf. Info.
▶ Self-defined Logo	Download ▼ Via Web UI Reset
▶ Self-defined CSS	Edit : Download ▼ Via Web UI Reset

FW Backup & Restore		
Item	Value Setting	Description
FW Upgrade	Via Web UI is selected by default	If new firmware is available, click the FW Upgrade button to upgrade the device firmware via Web UI , or Via Storage . After clicking on the “FW Upgrade” command button, you need to specify the file name of new firmware by using “Browse” button, and then click “Upgrade” button to start the FW upgrading process on this device. If you want to upgrade a firmware which is from GPL policy, please check “Accept unofficial firmware”
Backup Configuration Settings	Download is selected by default	You can backup or restore the device configuration settings by clicking the Via Web UI button. Download: for backup the device configuration to a config.bin file. Upload: for restore a designated configuration file to the device. Via Web UI: to retrieve the configuration file via Web GUI.
Auto Restore Configuration	The Enable box is unchecked by default	Click the Enable button to activate the customized default setting function. Once the function is activated, you can save the expected setting as a customized default setting by clicking the Save Conf. button, or clicking the Clean Conf. button to erase the stored customized configuration.

4G Vehicle Gateway

6.2.6 Reboot & Reset

For some special reason or situation, you may need to reboot the gateway or reset the device configuration to its default value. In addition to perform these operations through the Power ON/OFF, or pressing the reset button on the device panel, you can do it through the web GUI too.

Go to **Administration > System Operation > Reboot & Reset** tab.

In the Reboot & Reset window, you can reboot this device by clicking the “Reboot” button, and reset this device to default settings by clicking the “Reset” button.

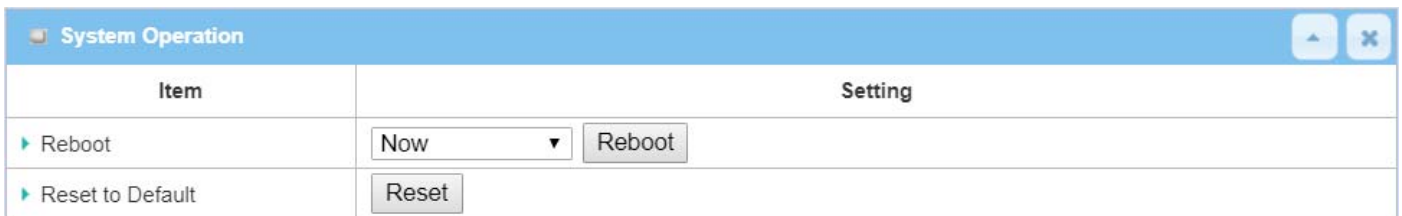

System Operation Window		
Item	Value Setting	Description
Reboot	Now is selected by default	Click the Reboot button to reboot the gateway immediately or on a pre-defined time schedule. Now: Reboot immediately Time Schedule: Select a pre-defined auto-reboot time schedule rule to reboot the auto device on a designated tim. To define a time schedule rule, go to Object Definition > Scheduling > Configuration tab.
Reset to Default	N/A	Click the Reset button to reset the device configuration to its default value.

4G Vehicle Gateway

6.3 FTP

The File Transfer Protocol (FTP) is a standard network protocol used to transfer computer files between a client and server on a computer network. FTP is built on a client-server model architecture and uses separate control and data connections between the client and the server. FTP users may authenticate themselves with a clear-text sign-in protocol, normally in the form of a username and password, but can connect anonymously if the server is configured to allow it.

For secure transmission that protects the username and password, and encrypts the content, FTP is often secured with SSL/TLS (FTPS). Besides, SSH File Transfer Protocol (SFTP) is sometimes also used instead, but is technologically different.

This gateway embedded FTP / SFTP server for administrator to download the log files to his computer or database. In the following two sections, you can configure the FTP server and create the user accounts that can login to the server. After login to the FTP server, you can browse the log directory and have the permission to download the stored log files and delete the files you have downloaded to make more storage space for further data logs.

The available log files can be system logs (refer to Administration > System Operation > System Log), Network Packets (refer to Administrator > Diagnostic > Packet Analyzer), Data Log (refer to Field Communication > Data Logging > Log File Management), and GNSS Log (refer to Service > Location Tracking > GNSS). With proper configuration for the various log functions that supported on your purchased product, you can download the log via FTP / SFTP connections.

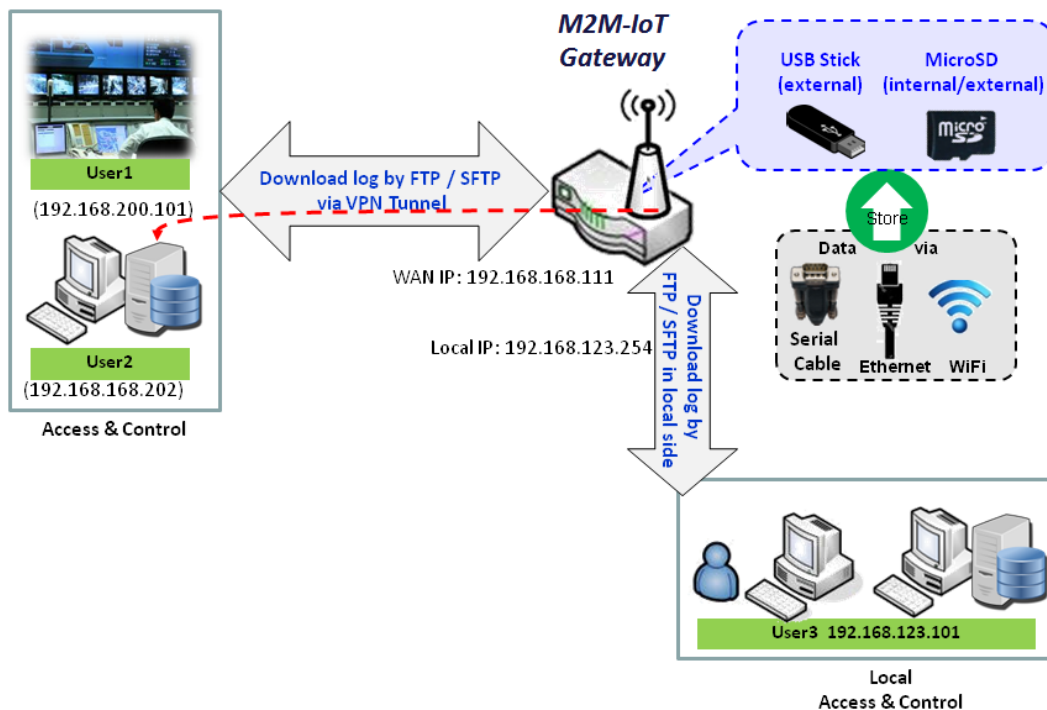

4G Vehicle Gateway

6.3.1 Server Configuration

This section allows user to setup the embedded FTP and SFTP server for retrieving the interested fog files.

Go to **Administration > FTP > Server Configuration** tab.

Enable FTP Server

Item	Setting
▶ FTP	<input checked="" type="checkbox"/> Enable
▶ FTP Port	<input type="text" value="21"/>
▶ Timeout	<input type="text" value="300"/> second(s)(60-7200)
▶ Max. Connections per IP	<input type="text" value="2"/> ▼
▶ Max. FTP Clients	<input type="text" value="5"/> ▼
▶ PASV Mode	<input type="checkbox"/> Enable
▶ Port Range of PASV Mode	<input type="text" value="50000"/> ~ <input type="text" value="50031"/>
▶ Auto Report External IP in PASV Mode	<input type="checkbox"/> Enable
▶ ASCII Transfer Mode	<input type="checkbox"/> Enable
▶ FTPS(FTP over SSL/TLS)	<input type="checkbox"/> Enable

Configuration Item	Value setting	Description
FTP	The box is unchecked by default.	Check Enable box to activate the embedded FTP Server function. With the FTP Server enabled, you can retrieve or delete the stored log files via FTP connection. Note: The embedded FTP Server is only for log downloading, so no any write permission is implemented for user file upload to the storage.
FTP Port	Port 21 is set by default	Specify a port number for FTP connection. The gateway will listen for incoming FTP connections on the specified port. Value Range: 1 ~ 65535.
Timeout	300 seconds is set by default.	Specify the maximum timeout interval for the FTP connection. Supported range is 60 to 7200 seconds.
Max. Connections per IP	2 Clients are set by default.	Specify the maximum number of clients from the same IP address for the FTP connection. Up to 5 clients from the same IP address is supported.
Max. FTP Clients	5 Clients are set by default.	Specify the maximum number of clients for the FTP connection. Up to 32 clients is supported.
PASV Mode	Optional setting	Check the Enable box to activate the support of PASV mode for a FTP connection from FTP clients.

4G Vehicle Gateway

Port Range of PASV Mode	Port 50000 ~ 50031 is set by default.	Specify the port range to allocate for PASV style data connection. Value Range: 1024 ~ 65535.
Auto Report External IP in PASV Mode	Optional setting	Check the Enable box to activate the support of overriding the IP address advertising in response to the PASV command.
ASCII Transfer Mode	Optional setting	Check the Enable box to activate the support of ASCII mode data transfers. Binary mode is supported by default.
FTPS (FTP over SSL/TLS)	Optional setting	Check the Enable box to activate the support of secure connections via SSL/TLS.

Enable SFTP Server

The screenshot shows a configuration window titled "SFTP Server Configuration" with a "Save" button. The window contains a table with two rows:

Item	Setting
▶ SFTP	<input type="checkbox"/> Enable via <input checked="" type="checkbox"/> LAN via <input checked="" type="checkbox"/> WAN (WAN-1 <input checked="" type="checkbox"/> WAN-4 <input type="checkbox"/>) <input type="text"/>
▶ SFTP Port	<input type="text" value="22"/>

Configuration		
Item	Value setting	Description
SFTP	The box is unchecked by default.	Check Enable box to activate the embedded SFTP Server function. Furthermore, you can check the granted interface(s) for the SFTP connection, via LAN , WAN , or both. <ul style="list-style-type: none"> With the SFTP Server enabled, you can retrieve or delete the stored log files via secure SFTP connection.
SFTP Port	Default 22	Specify a port number for SFTP connection. The gateway will listen for incoming SFTP connections on the specified port. Value Range: 1 ~ 65535.

4G Vehicle Gateway

6.3.2 User Account

This section allows user to setup user accounts for logging to the embedded FTP and SFTP server to retrieve the interested fog files.

Go to **Administration > FTP > User Account** tab.

Create/Edit FTP User Accounts

ID	User Name	Password	Directory	Permission	Enable	Actions
----	-----------	----------	-----------	------------	--------	---------

When **Add** button is applied, **User Account Configuration** screen will appear.

Item	Setting
User Name	admin
Password
Directory	Browse
Permission	Read/Write ▾
Enable	<input checked="" type="checkbox"/>

Configuration Item	Value setting	Description
User Name	String : non-blank string	Enter the user account for login to the FTP server. Value Range: 1 ~ 15 characters.
Password	String : no blank	Enter the user password for login to the FTP server.
Directory	N/A	Select a root directory after user login.
Permission	Read/Write is selected by default.	Select the Read/write permission. Note: The embedded FTP Server is only for log downloading, so no any write permission is implemented for user file upload to the storage, even Read/Write option is selected.
Enable	The box is checked by default.	Check the box to activate the FTP user account.

4G Vehicle Gateway

6.4 Diagnostic

This gateway supports simple network diagnosis tools for the administrator to troubleshoot and find the root cause of the abnormal behavior or traffics passing through the gateway. There can be a Packet Analyzer to help record the packets for a designated interface or specific source/destination host, and another Ping and Tracert tools for testing the network connectivity issues.

6.4.1 Diagnostic Tools

The Diagnostic Tools provide some frequently used network connectivity diagnostic tools (approaches) for the network administrator to check the device connectivity.

Go to **Administration > Diagnostic > Diagnostic Tools** tab.

Item	Setting
Ping Test	Host IP: <input type="text"/> Outer Interface: <input type="text" value="Auto"/> LAN Source: <input type="text" value="Default"/> <input type="button" value="Ping"/>
Tracert Test	Host IP: <input type="text"/> Interface: <input type="text" value="Auto"/> <input type="text" value="UDP"/> <input type="button" value="Tracert"/>
Speed Test	Interface: <input type="text" value="Auto"/> mode: <input type="text" value="DL+UL"/> <input type="checkbox"/> SSL <input type="button" value="Test"/>
Wake on LAN	<input type="text"/> <input type="button" value="Wake up"/>

Diagnostic Tools		
Item	Value setting	Description
Ping Test	Optional Setting	This allows you to specify an IP / FQDN, the Outer interface (auto, WAN, LAN, or VLAN), and LAN source (default, LAN, or VLAN) as well, so system will try to ping the specified device to test whether it is alive after clicking on the Ping button. A test result window will appear beneath it.
Tracert Test	Optional setting	Trace route (tracert) command is a network diagnostic tool for displaying the route (path) and measuring transit delays of packets across an IP network. Trace route proceeds until all (three) sent packets are lost for more than twice, then the connection is lost and the route cannot be evaluated. First, you need to specify an IP / FQDN, the test interface (LAN, WAN, or Auto) and the protocol (UDP or ICMP), and by default, it is UDP . Then, system will try to trace the specified host to test whether it is alive after clicking on Tracert button. A test result window will appear beneath it.
Speed Test	Optional setting	This allow you to do q quick speed test for verifying the connectivity on specific interface.
Wake on LAN	Optional setting	Wake on LAN (WOL) is an Ethernet networking standard that allows a computer to be turned on or awakened by a network message. You can specify the MAC address of the computer, in your LAN network, to be remotely turned on by clicking on the Wake up command button.

4G Vehicle Gateway

Save	N/A	Click the Save button to save the configuration.
------	-----	---

4G Vehicle Gateway

6.4.2 Packet Analyzer

The Packet Analyzer can capture packets depend on user settings. User can specify interfaces to capture packets and filter by setting rule. Ensure the log storage is available (either embedded SD-Card or external USB Storage), otherwise **Packet Analyzer** cannot be enabled.

Go to **Administration > Diagnostic > Packet Analyzer** tab.

Item	Setting
▶ Packet Analyzer	<input type="checkbox"/> Enable
▶ File Name	<input type="text"/>
▶ Split Files	<input type="checkbox"/> Enable File Size : <input type="text" value="200"/> <input type="text" value="KB"/>
▶ Packet Interfaces	<input type="checkbox"/> WAN-1 <input type="checkbox"/> WAN-2 <input type="checkbox"/> WAN-3 <input type="checkbox"/> WAN-4 <input type="checkbox"/> ASY <input type="text" value="Binary Mode"/> 2.4G : <input type="checkbox"/> VAP-1 <input type="checkbox"/> VAP-2 <input type="checkbox"/> VAP-3 <input type="checkbox"/> VAP-4 <input type="checkbox"/> VAP-5 <input type="checkbox"/> VAP-6 <input type="checkbox"/> VAP-7 <input type="checkbox"/> VAP-8 5G : <input type="checkbox"/> VAP-1 <input type="checkbox"/> VAP-2 <input type="checkbox"/> VAP-3 <input type="checkbox"/> VAP-4 <input type="checkbox"/> VAP-5 <input type="checkbox"/> VAP-6 <input type="checkbox"/> VAP-7 <input type="checkbox"/> VAP-8

Configuration		
Item	Value setting	Description
Packet Analyzer	The box is unchecked by default.	Check Enable box to activate the Packet Analyzer function. If you cannot enable the checkbox, please check if the storage is available or not. Plug in the USB storage and then enable the Package Analyzer function.
File Name	1. An optional setting 2. Blank is set by default, and the default file name is <Interface>_<Date>_<index>.	Enter the file name to save the captured packets in log storage. If Split Files option is also enabled, the file name will be appended with an index code “_<index>”. The extension file name is .pcap .
Split Files	1. An optional setting 2. The default value of File Size is 200 KB.	Check enable box to split file whenever log file reaching the specified limit. If the Split Files option is enabled, you can further specify the File Size and Unit for the split files. Value Range: 10 ~ 99999. NOTE: File Size cannot be less than 10 KB
Packet Interfaces	An optional setting	Define the interface(s) that Packet Analyzer should work on. At least, one interface is required, but multiple selections are also accepted. The supported interfaces can be: <ul style="list-style-type: none"> ● WAN: When the WAN is enabled at Physical Interface, it can be selected here. ● ASY: This means the serial communication interface. It is used to capture packets appearing in the Field Communication.

4G Vehicle Gateway

		Therefore, it can only be selected when specific field communication protocol, like Modbus, is enabled. Select Binary mode or String mode for the serial interface.
		<ul style="list-style-type: none"> ● VAP: This means the virtual AP. When WiFi and VAP are enabled, it can be selected here.
Save	N/A	Click the Save button to save the configuration.
Undo	N/A	Click the Undo button to restore what you just configured back to the previous setting.

Once you enabled the Packet Analyzer function on specific Interface(s), you can further specify some filter rules to capture the packets which matched the rules.

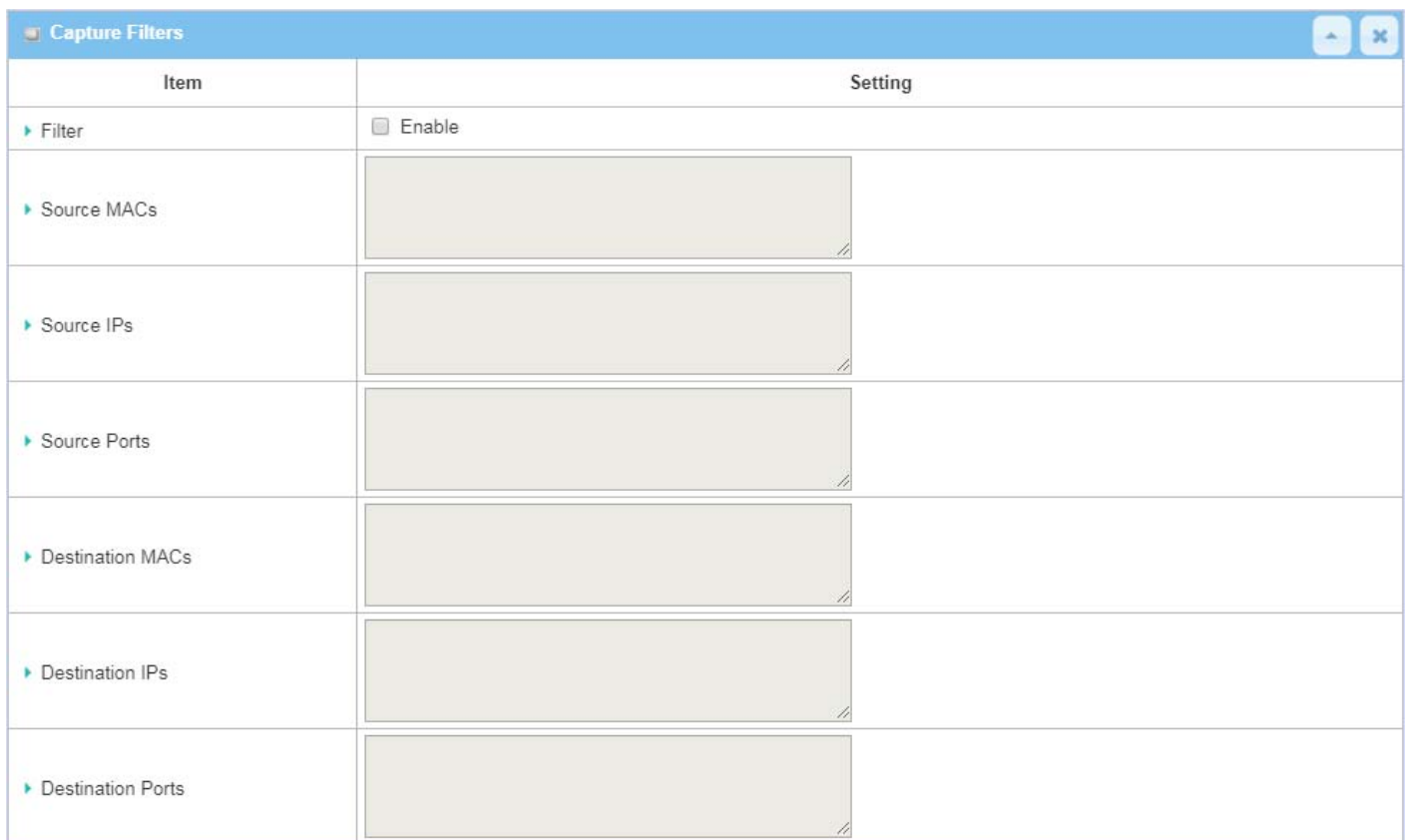

Capture Filters		
Item	Value setting	Description
Filter	Optional setting	Check Enable box to activate the Capture Filter function.
Source MACs	Optional setting	Define the filter rule with Source MACs , which means the source MAC address of packets. Packets which match the rule will be captured. Up to 10 MACs are supported, but they must be separated with “;”, e.g. AA:BB:CC:DD:EE:FF; 11:22:33:44:55:66 The packets will be captured when match any one MAC in the rule.
Source IPs	Optional setting	Define the filter rule with Source IPs , which means the source IP address of packets.

4G Vehicle Gateway

		<p>Packets which match the rule will be captured. Up to 10 IPs are supported, but they must be separated with “;”, e.g. 192.168.1.1; 192.168.1.2 The packets will be captured when match any one IP in the rule.</p>
Source Ports	Optional setting	<p>Define the filter rule with Source Ports, which means the source port of packets. The packets will be captured when match any port in the rule. Up to 10 ports are supported, but they must be separated with “;”, e.g. 80; 53 Value Range: 1 ~ 65535.</p>
Destination MACs	Optional setting	<p>Define the filter rule with Destination MACs, which means the destination MAC address of packets. Packets which match the rule will be captured. Up to 10 MACs are supported, but they must be separated with “;”, e.g. AA:BB:CC:DD:EE:FF; 11:22:33:44:55:66 The packets will be captured when match any one MAC in the rule.</p>
Destination IPs	Optional setting	<p>Define the filter rule with Destination IPs, which means the destination IP address of packets. Packets which match the rule will be captured. Up to 10 IPs are supported, but they must be separated with “;”, e.g. 192.168.1.1; 192.168.1.2 The packets will be captured when match any one IP in the rule.</p>
Destination Ports	Optional setting	<p>Define the filter rule with Destination Ports, which means the destination port of packets. The packets will be captured when match any port in the rule. Up to 10 ports are supported, but they must be separated with “;”, e.g. 80; 53 Value Range: 1 ~ 65535.</p>

4G Vehicle Gateway

Chapter 7 Service

7.1 Cellular Toolkit

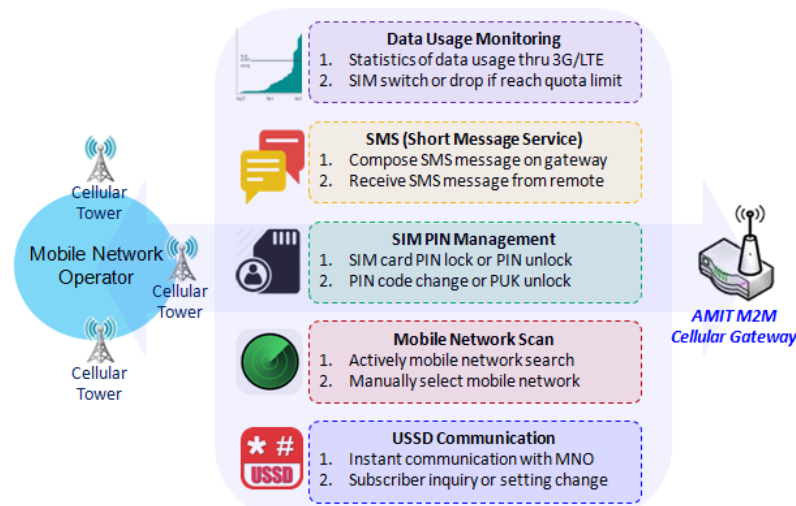

Besides cellular data connection, you may also like to monitor data usage of cellular WAN, sending text message through SMS, changing PIN code of SIM card, communicating with carrier/ISP by USSD command, or doing a cellular network scan for diagnostic purpose.

In Cellular Toolkit section, it includes several useful features that are related to cellular configuration or application. You can configure settings of Data Usage, SMS, SIM PIN, USSD, and Network Scan here. Please note at least a valid SIM card is required to be

inserted to device before you continue settings in this section.

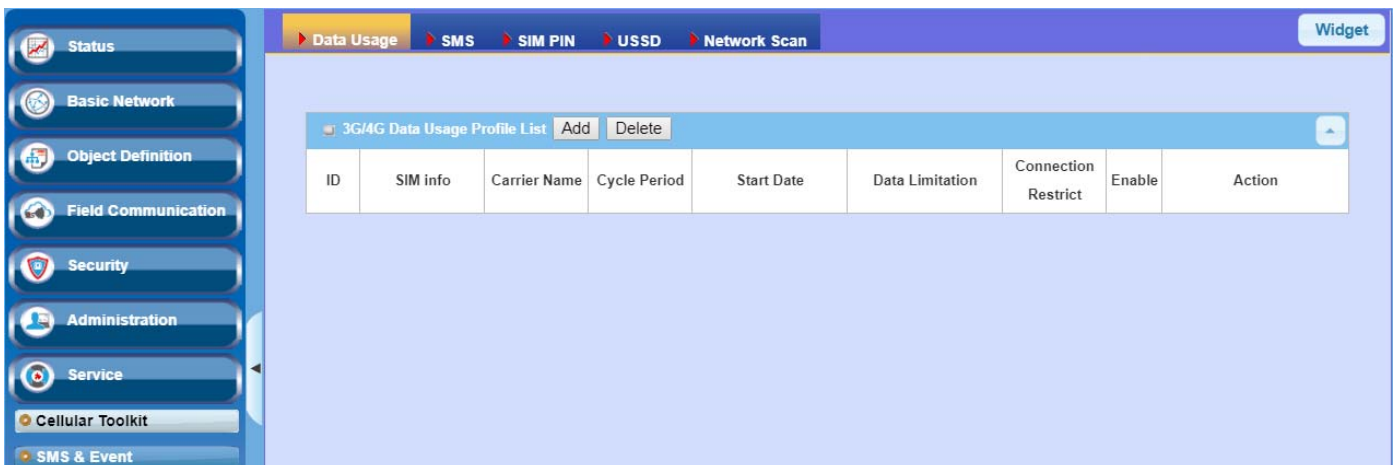

4G Vehicle Gateway

7.1.1 Data Usage

Most of data plan for cellular connection is with a limited amount of data usage. If data usage has been over limited quota, either you will get much lower data throughput that may affect your daily operation, or you will get a 'bill shock' in the next month because carrier/ISP charges a lot for the over-quota data usage.

With help from Data Usage feature, device will monitor cellular data usage continuously and take actions. If data usage reaches limited quota, device can be set to drop the cellular data connection right away. Otherwise, if secondary SIM card is inserted, device will switch to secondary SIM and establish another cellular data connection with secondary SIM automatically.

If Data Usage feature is enabled, all history of cellular data usage can be viewed at **Status > Statistics & Reports > Cellular Usage** tab.

ID	SIM info	Carrier Name	Cycle Period	Start Date	Data Limitation	Connection Restrict	Enable	Action
1	3G/4G SIM A	ISP A	1 Monthly	Mon Apr 01 2019 00:00:00 GMT+0800	1GB	<input checked="" type="checkbox"/>	<input checked="" type="checkbox"/>	<input type="button" value="Edit"/> <input type="checkbox"/> Select

3G/4G Data Usage

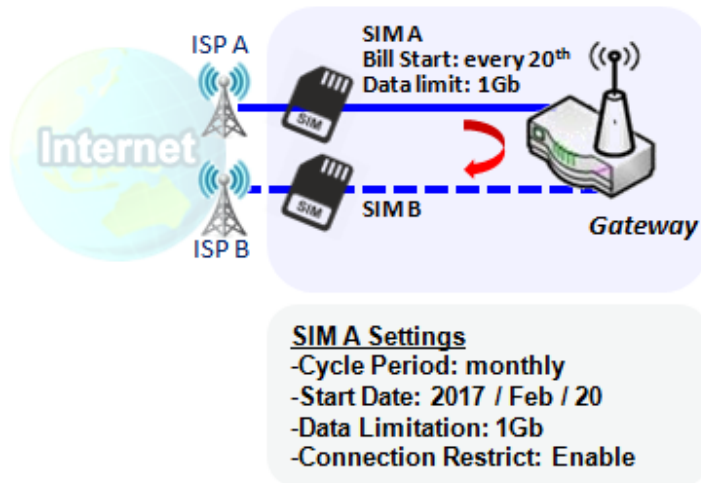

Data Usage feature enabling gateway device to continuously monitor cellular data usage and take actions. In the diagram, quota limit of SIM A is **1Gb** per month and bill start date is **20th** of every month. The device is smart to start a new calculation of data usage on every 20th of month. Enable Connection Restrict will force gateway device to drop cellular connection of SIM A when data usage reaches quota limit (1Gb in this case). If SIM failover feature is configured in **Internet Setup**, then gateway will switch to SIM B and establish a new cellular data connection automatically.

4G Vehicle Gateway

Data Usage Setting

Go to **Service > Cellular Toolkit > Data Usage** tab.

Before finished settings for Data Usage, you need to know bill start date, bill period, and quota limit of data usage according to your data plan. You can ask this information from your carrier or ISP.

Create / Edit 3G/4G Data Usage Profile

3G/4G Data Usage Profile List Add Delete								
ID	SIM info	Carrier Name	Cycle Period	Start Date	Data Limitation	Connection Restrict	Enable	Action

When **Add** button is applied, 3G/4G Data Usage Profile Configuration screen will appear. You can create up to four data usage profiles, one profile for each SIM card used in the Gateway.

3G/4G Data Usage Profile Configuration	
Item	Setting
▶ SIM Select	3G/4G ▼ SIM A ▼
▶ Carrier Name	<input type="text"/>
▶ Cycle Period	Days ▼ <input type="text"/>
▶ Start Date	2019 ▼ / April ▼ / 1 ▼
▶ Data Limitation	<input type="text"/> KB ▼
▶ Connection Restrict	<input type="checkbox"/> Enable
▶ Enable	<input checked="" type="checkbox"/> Enable

3G/4G Data Usage Profile Configuration		
Item	Setting	Description
SIM Select	3G/4G-1 and SIM A by default.	Choose a cellular interface (3G/4G-1 or 3G/4G-2), and a SIM card bound to the selected cellular interface to configure its data usage profile. Note: 3G/4G-2 is only available for for the product with dual cellular module.
Carrier Name	It is an optional item.	Fill in the Carrier Name for the selected SIM card for identification.
Cycle Period	Days by default	The first box has three types for cycle period. They are Days , Weekly and Monthly . Days: For per Days cycle periods, you have to further specify the number of days in the second box. Value Range: 1 ~ 90 days. Weekly, Monthly: The cycle period is one week or one month.
Start Date	N/A	Specify the date to start measure network traffic. Please don't select the day before now, otherwise, the traffic statistics will be incorrect.
Data Limitation	N/A	Specify the allowable data limitation for the defined cycle period.

4G Vehicle Gateway

Connection Restrict	Un-Checked by default.	Check the Enable box to activate the connection restriction function. During the specified cycle period, if the actual data usage exceeds the allowable data limitation, the cellular connection will be forced to disconnect.
Enable	Un-Checked by default.	Check the Enable box to activate the data usage profile.

4G Vehicle Gateway

7.1.2 SMS

Short Message Service (SMS) is a text messaging service, which is used to be widely-used on mobile phones. It uses standardized communications protocols to allow mobile phones or cellular devices to exchange short text messages in an instant and convenient way.

SMS Setting

Go to **Service > Cellular Toolkit > SMS** tab

With this gateway device, you can send SMS text messages or browse received SMS messages as you usually do on a cellular phone.

Setup SMS Configuration

Item	Setting
Physical Interface	3G/4G-1 ▼
SMS	<input type="checkbox"/> Enable SIM Status: SIM_A
SMS Storage	SIM Card Only ▼
SMS Space	<input type="checkbox"/> Enable & Keep Available Space <input type="text" value=""/> (1-10)

Configuration Item	Value setting	Description
Physical Interface	The box is 3G/4G-1 by default	Choose a cellular interface (3G/4G-1 or 3G/4G-2) for the following SMS function configuration. Note: 3G/4G-2 is only available for for the product with dual cellular module.
SMS	The box is checked by default	This is the SMS switch. If the box checked that the SMS function enable, if the box unchecked that the SMS function disable.
SIM Status	N/A	Depend on currently SIM status. The possible value will be SIM_A or SIM_B .
SMS Storage	The box is SIM Card Only by default	This is the SMS storage location. Currently the option only SIM Card Only .
SMS Space	The box is unchecked by default	Check the Enable box and specify a number (1-10) for message count to reserve some available storage space and prevent it from run out of storage. The oldest message(s) will be deleted when the SMS storage is going to full.
Save	N/A	Click the Save button to save the settings

4G Vehicle Gateway

SMS Summary

Show **Unread SMS**, **Received SMS**, **Sent SMS**, **Remaining SMS**, and edit SMS context to send, read SMS from SIM card.

SMS Summary	
▶ Unread SMS	0
▶ Received SMS	10
▶ Sent SMS	0
▶ Remaining SMS	0

Item	Value setting	Description
Unread SMS	N/A	If SIM card insert to router first time, unread SMS value is zero. When received the new SMS but didn't read, this value plus one.
Received SMS	N/A	This value record the existing SMS numbers from SIM card, When received the new SMS, this value plus one.
Sent SMS	N/A	This value record the number of out going SMS, When sent one SMS, this value plus one.
Remaining SMS	N/A	This value is SMS capacity minus received SMS, When received the new SMS, this value minus one.
New SMS	N/A	Click New SMS button, a New SMS screen appears. User can set the SMS setting from this screen. Refer to New SMS in the next page.
SMS Inbox	N/A	Click SMS Inbox button, a SMS Inbox List screen appears. User can read or delete SMS, reply SMS or forward SMS from this screen. Refer to SMS Inbox List in the next page.
Refresh	N/A	Click the Refresh button to update the SMS summary immediately.

4G Vehicle Gateway

New SMS

You can set the SMS setting from this screen.

Item	Setting
Receivers	<input type="text"/> (Use '+' for International Format and ';' to Compose Multiple Receivers)
Text Message	<div style="border: 1px solid #ccc; height: 100px; width: 100%;"></div> Length of Current Input : 0
Result	

New SMS		
Item	Value setting	Description
Receivers	N/A	Write the receivers to send SMS. User need to add the semicolon and compose multiple receivers that can group send SMS.
Text Message	N/A	Write the SMS context to send SMS. The router supports up to a maximum of 1023 character for SMS context length.
Send	N/A	Click the Send button, above text message will be sent as a SMS.
Result	N/A	If SMS has been sent successfully, it will show Send OK , otherwise Send Failed will be displayed.

SMS Inbox List

You can read or delete SMS, reply SMS or forward SMS from this screen.

ID	From Phone Number	Timestamp	SMS Text Preview	Actions

SMS Inbox List		
Item	Value setting	Description
ID	N/A	The number of SMS.
From Phone Number	N/A	Sender List (Phone Number) for the received SMS
Timestamp	N/A	What time the SMS is received
SMS Text Preview	N/A	Preview the SMS text. Click the Detail button to read a certain message.

4G Vehicle Gateway

Action	The box is unchecked by default	Click the Detail button to read the SMS detail; Click the Reply / Forward button to reply/forward SMS. Besides, you can check the box(es), and then click the Delete button to delete the checked SMS(s).
Refresh	N/A	Refresh the SMS Inbox List.
Delete	N/A	Delete the SMS for all checked box from Action.
Close	N/A	Close the Detail SMS Message screen.

SMS Sent Folder

You can read or delete SMS from this screen.

SMS Sent Folder					Delete	Close	Previous	0 ▼	Next	
ID	Receivers	Timestamp	SMS Text Preview	Actions						

SMS Sent Folder		
Item	Value setting	Description
ID	N/A	The number of SMS.
Receivers	N/A	Receiver list for the sent SMS.
Timestamp	N/A	What time the SMS is sent
SMS Text Preview	N/A	Preview the SMS text. Click the Detail button to read a certain message.
Action	The box is unchecked by default	Click the Detail button to read the SMS detail Besides, you can check the box(es), and then click the Delete button to delete the checked record(s).
Refresh	N/A	Refresh the SMS Sent Folder.
Delete	N/A	Delete the SMS for all checked box from Action.
Close	N/A	Close the Detail SMS Message screen.

4G Vehicle Gateway

7.1.3 SIM PIN

With most cases in the world, users need to insert a SIM card (a.k.a. UICC) into end devices to get on cellular network for voice service or data surfing. The SIM card is usually released by mobile operators or service providers. Each SIM card has a unique number (so-called ICCID) for network owners or service providers to identify each subscriber. As SIM card plays an important role between service providers and subscribers, some security mechanisms are required on SIM card to prevent any unauthorized access.

Enabling a PIN code in SIM card is an easy and effective way of protecting cellular devices from unauthorized access. This gateway device allows you to activate and manage PIN code on a SIM card through its web GUI.

Activate PIN code on SIM Card

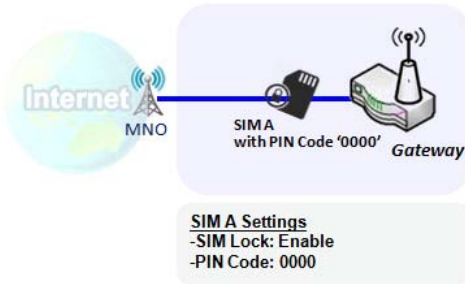

This gateway device allows you to activate PIN code on SIM card. This example shows how to activate PIN code on SIM-A for 3G/4G-1 with default PIN code “0000”.

Change PIN code on SIM Card

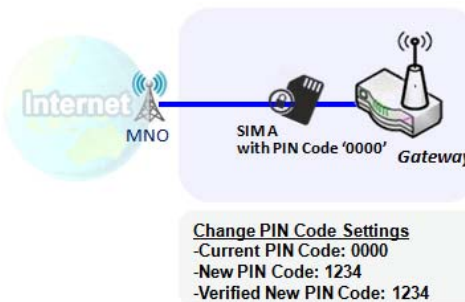

This gateway device allows you to change PIN code on SIM card. Following the example above, you need to type original PIN code “0000”, and then type new PIN code with ‘1234’. To confirm the new PIN code you type is what you want, you need to type new PIN code ‘1234’ in Verified New PIN Code again.

Unlock SIM card by PUK Code

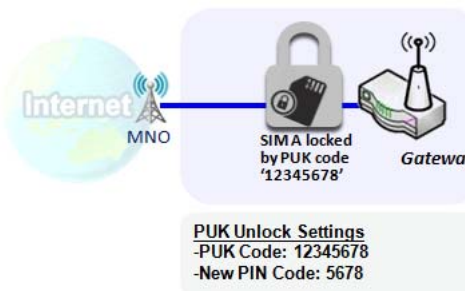

If you entered incorrect PIN code at configuration page for 3G/4G-1 WAN over three times, and then it will cause SIM card to be locked by PUK code. Then you have to call service number to get a PUK code to unlock SIM card. In the diagram, the PUK code is “12345678” and new PIN code is “5678”.

4G Vehicle Gateway

4G Vehicle Gateway

SIM PIN Setting

Go to **Service > Cellular Toolkit > SIM PIN** Tab

With the SIM PIN Function window, it allows you to enable or disable SIM lock (which means protected by PIN code), or change PIN code. You can also see the information of remaining times of failure trials as we mentioned earlier. If you run out of these failure trials, you need to get a PUK code to unlock SIM card.

Select a SIM Card



Item	Setting
▶ Physical Interface	3G/4G-1 ▼
▶ SIM Status	SIM-A Ready
▶ SIM Selection	SIM-A ▼ <input type="button" value="Switch"/>

Configuration Window		
Item	Value setting	Description
Physical Interface	The box is 3G/4G-1 by default	Choose a cellular interface (3G/4G-1 or 3G/4G-2) to change the SIM PIN setting for the selected SIM Card. Note: 3G/4G-2 is only available for the product with dual cellular module.
SIM Status	N/A	Indication for the selected SIM card and the SIM card status. The status could be Ready , Not Insert , or SIM PIN . Ready -- SIM card is inserted and ready to use. It can be a SIM card without PIN protection or that SIM card is already unlocked by correct PIN code. Not Insert -- No SIM card is inserted in that SIM slot. SIM PIN -- SIM card is protected by PIN code, and it's not unlocked by a correct PIN code yet. That SIM card is still at locked status.
SIM Selection	N/A	Select the SIM card for further SIM PIN configuration. Press the Switch button, then the Gateway will switch SIM card to another one. After that, you can configure the SIM card.

4G Vehicle Gateway

Enable / Change PIN Code

Enable or Disable PIN code (password) function, and even change PIN code function.

SIM function	
<input type="button" value="Save"/> <input type="button" value="Change PIN Code"/>	
Item	Setting
▶ PIN Lock	<input checked="" type="checkbox"/> Enable PIN Code: <input type="text"/> (4~8 digits)
▶ Remaining times	N/A

SIM function Window		
Item Setting	Value setting	Description
SIM lock	Depend on SIM card	Click the Enable button to activate the SIM lock function. For the first time you want to enable the SIM lock function, you have to fill in the PIN code as well, and then click Save button to apply the setting.
Remaining times	Depend on SIM card	Represent the remaining trial times for the SIM PIN unlocking.
Save	N/A	Click the Save button to apply the setting.
Change PIN Code	N/A	Click the Change PIN code button to change the PIN code (password). If the SIM Lock function is not enabled, the Change PIN code button is disabled. In the case, if you still want to change the PIN code, you have to enable the SIM Lock function first, fill in the PIN code, and then click the Save button to enable. After that, You can click the Change PIN code button to change the PIN code.

When **Change PIN Code** button is clicked, the following screen will appear.

Item	Setting
▶ Current PIN Code	<input type="text"/> (4~8 digits)
▶ New PIN Code	<input type="text"/> (4~8 digits)
▶ Verified New PIN Code	<input type="text"/> (4~8 digits)

Item	Value Setting	Description
Current PIN Code	A Must filled setting	Fill in the current (old) PIN code of the SIM card.
New PIN Code	A Must filled setting	Fill in the new PIN Code you want to change.
Verified New PIN Code	A Must filled setting	Confirm the new PIN Code again.
Apply	N/A	Click the Apply button to change the PIN code with specified new PIN code.
Cancel	N/A	Click the Cancel button to cancel the changes and keep current PIN code.

Note: If you changed the PIN code for a certain SIM card, you must also change the corresponding PIN code specified in the **Basic Network > WAN & Uplink > Internet Setup > Connection with SIM Card** page.

4G Vehicle Gateway

Otherwise, it may result in wrong SIM PIN trials with invalid (old) PIN code.

Unlock with a PUK Code

The PUK Function window is only available for configuration if that SIM card is locked by PUK code. It means that SIM card is locked and needs additional PUK code to unlock. Usually it happens after too many trials of incorrect PIN code, and the remaining times in SIM Function table turns to 0. In this situation, you need to contact your service provider and request a PUK code for your SIM card, and try to unlock the locked SIM card with the provided PUK code. After unlocking a SIM card by PUK code successfully, the SIM lock function will be activated automatically.



Item	Setting
▶ PUK status	PUK unlock.
▶ Remaining times	N/A
▶ PUK Code	<input type="text"/> (8 digits)
▶ New PIN Code	<input type="text"/> (4~8 digits)

PUK Function Window		
Item	Value setting	Description
PUK status	PUK Unlock / PUK Lock	Indication for the PUK status. The status could be PUK Lock or PUK Unlock . As mentioned earlier, the SIM card will be locked by PUK code after too many trials of failure PIN code. In this case, the PUK Status will turns to PUK Lock . In a normal situation, it will display PUK Unlock .
Remaining times	Depend on SIM card	Represent the remaining trial times for the PUK unlocking. Note : DO NOT make the remaining times down to zero, it will damage the SIM card FOREVER ! Call for your ISP's help to get a correct PUK and unlock the SIM if you don't have the PUK code.
PUK Code	A Must filled setting	Fill in the PUK code (8 digits) that can unlock the SIM card in PUK unlock status.
New PIN Code	A Must filled setting	Fill in the New PIN Code (4~8 digits) for the SIM card. You have to determine your new PIN code to replace the old, forgotten one. Keep the PIN code (password) in mind with care.
Save	N/A	Click the Save button to apply the setting.

Note: If you changed the PUK code and PIN code for a certain SIM card, you must also change the corresponding PIN code specified in the **Basic Network > WAN & Uplink > Internet Setup > Connection with SIM Card** page. Otherwise, it may result in wrong SIM PIN trials with invalid (old) PIN code.

4G Vehicle Gateway

7.1.4 USSD

Unstructured Supplementary Service Data (USSD) is a protocol used by GSM cellular telephones to communicate with the service provider's computers. USSD can be used for WAP browsing, prepaid callback service, mobile-money services, location-based content services, menu-based information services, and as part of configuring the phone on the network.

An USSD message is up to 182 alphanumeric characters in length. Unlike Short Message Service (SMS) messages, USSD messages create a real-time connection during an USSD session. The connection remains open, allowing a two-way exchange of a sequence of data. This makes USSD more responsive than services that use SMS.

Configuration	
Item	Setting
Physical Interface	3G/4G-1 SIM Status: SIM_A

USSD Profile List				
ID	Profile Name	USSD Command	Comments	Actions
Add Delete				

USSD Request	
Item	Setting
USSD Profile	--- Option ---
USSD Command	

USSD Scenario

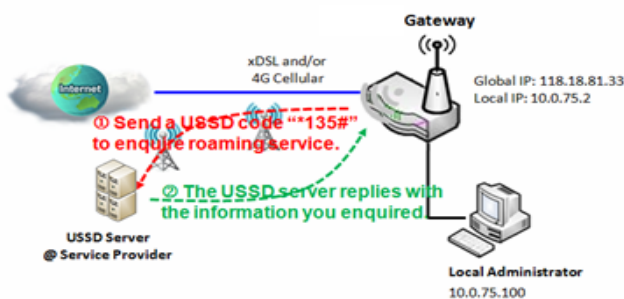

USSD allows you to have an instant bi-directional communication with carrier/ISP. In the diagram, the USSD command ***135#** is referred to data roaming services. After sending that USSD command to carrier, you can get a response at window USSD Response. Please note the USSD command varies for different carriers/ISP.

4G Vehicle Gateway

USSD Setting

Go to **Service > Cellular Toolkit > USSD** tab.

In "USSD" page, there are four windows for the USSD function. The "Configuration" window can let you specify which 3G/4G module (physical interface) is used for the USSD function, and system will show which SIM card in the module is the current used one. The second window is the "USSD Profile List" and it shows all your defined USSD profiles that store pre-commands for activating an USSD session. An "Add" button in the window can let you add one new USSD profile and define the command for the profile in the third window, the "USSD Profile Configuration". When you want to start the activation of an USSD connection session to the USSD server, select the USSD profile or type in the correct pre-command, and then click on the "Send" button for the session. The responses from the USSD server will be displayed beneath the "USSD Command" line. When commands typed in the "USSD Command" field are sent, received responses will be displayed in the "USSD Response" blank space. User can communicate with the USSD server by sending USSD commands and getting USSD responses via the gateway.

USSD Configuration

Item	Setting
Physical Interface	3G/4G-1 SIM Status: SIM_A

Configuration Item	Value setting	Description
Physical Interface	The box is 3G/4G-1 by default.	Choose a cellular interface (3G/4G-1 or 3G/4G-2) to configure the USSD setting for the connected cellular service (identified with SIM_A or SIM_B). Note: 3G/4G-2 is only available for for the product with dual cellular module.
SIM Status	N/A	Show the connected cellular service (identified with SIM_A or SIM_B).

Create / Edit USSD Profile

The cellular gateway allows you to custom your USSD profile. It supports up to a maximum of 35 USSD profiles.

ID	Profile Name	USSD Command	Comments	Actions
----	--------------	--------------	----------	---------

When **Add** button is applied, **USSD Profile Configuration** screen will appear.

4G Vehicle Gateway

USSD Request
Send
Clear
Cancel

Item	Setting
▶ USSD Profile	--- Option --- ▼
▶ USSD Command	<input style="width: 100%;" type="text"/>

USSD Profile Configuration		
Item	Value setting	Description
Profile Name	N/A	Enter a name for the USSD profile.
USSD Command	N/A	Enter the USSD command defined for the profile. Normally, it is a command string composed with numeric keypad "0~9", "*", and "#". The USSD commands are highly related to the cellular service, please check with your service provider for the details.
Comments	N/A	Enter a brief comment for the profile.

Send USSD Request

When **send** the USSD command, the USSD Response screen will appear.

When click the **Clear** button, the USSD Response will disappear.

USSD Request
Send
Clear
Cancel

Item	Setting
▶ USSD Profile	--- Option --- ▼
▶ USSD Command	<input style="width: 100%;" type="text"/>

USSD Request		
Item	Value setting	Description
USSD Profile	N/A	Select a USSD profile name from the dropdown list.
USSD Command	N/A	The USSD Command string of the selected profile will be shown here.
USSD Response	N/A	Click the Send button to send the USSD command, and the USSD Response screen will appear. You will see the response message of the corresponding service, receive the service SMS.

4G Vehicle Gateway

7.1.5 Network Scan

"Network Scan" function can let administrator specify the device how to connect to the mobile system for data communication in each 3G/4G interface. For example, administrator can specify which generation of mobile system is used for connection, 2G, 3G or LTE. Moreover, he can define their connection sequence for the gateway device to connect to the mobile system automatically. Administrator also can scan the mobile systems in the air manually, select the target operator system and apply it. The manual scanning approach is used for problem diagnosis.

Network Scan Setting

Go to **Service > Cellular Toolkit > Network Scan** tab.

In "Network Scan" page, there are two windows for the Network Scan function. The "Configuration" window can let you select which 3G/4G module (physical interface) is used to perform Network Scan, and system will show the current used SIM card in the module. You can configure each 3G/4G WAN interface by executing the network scanning one after another. You can also specify the connection sequence of the targeted generation of mobile system, 2G/3G/LTE.

Network Scan Configuration

Configuration	
Item	Setting
▶ Physical Interface	3G/4G-1 ▼ SIM Status: SIM_A
▶ Network Type	LTE Only ▼
▶ Scan Approach	Auto ▼

Configuration		
Item	Value setting	Description
Physical Interface	The box is 3G/4G-1 by default	Choose a cellular interface (3G/4G-1 or 3G/4G-2) for the network scan function. Note: 3G/4G-2 is only available for for the product with dual cellular module.
SIM Status	N/A	Show the connected cellular service (identified with SIM_A or SIM_B).
Network Type	Auto is selected by default.	Specify the network type for the network scan function. It can be Auto, 2G Only, 2G prefer, 3G Only, 3G prefer, or LTE Only. When Auto is selected, the network will be register automatically; If the prefer option is selected, network will be register for your option first; If the only option is selected, network will be register for your option only.
Scan Approach	Auto is selected by default.	When Auto selected, cellular module register automatically. If the Manually option is selected, a Network Provider List screen appears. Press Scan button to scan for the nearest base stations. Select (check the box) the preferred base stations then click Apply button to apply settings.

4G Vehicle Gateway

Save	N/A	Click Save to save the settings
-------------	-----	--

The second window is the "Network Provider List" window and it appears when the **Manually** Scan Approach is selected in the Configuration window. By clicking on the "Scan" button and wait for 1 to 3 minutes, the found mobile operator system will be displayed for you to choose. Click again on the "Apply" button to drive system to connect to that mobile operator system for the dedicated 3G/4G interface.

Network Provider List Scan Apply ▲			
Provider Name	Mobile System	Network Status	Action

4G Vehicle Gateway

7.2 SMS & Event

SMS & Event handling is the application that allows administrator to setup the pre-defined events, handlers, or response behavior with individual profiles. With properly configuring the event handling function, administrator can easily and remotely obtain the status and information via the purchased gateway. Moreover, he can also handle and manage some important system related functions, even the field bus devices and D/O devices which are already well connected to.

The supported events are categorized into two groups: the **managing events** and **notifying events**.

The **managing events** are the events that are used to manage the gateway or change the setting / status of the specific functionality of the gateway. On receiving the managing event, the gateway will take action to change the functionality, collect the required status for administration, and also change the status of a certain connected field bus device simultaneously.

The **notifying events** are the events that some related objects have been triggered and take corresponding actions on the occurrence of the events. It could be an event generated from the connected sensor, or a certain connected field bus device for alerting the administrator something happened with SMS message, Email, and SNMP Trap, etc...

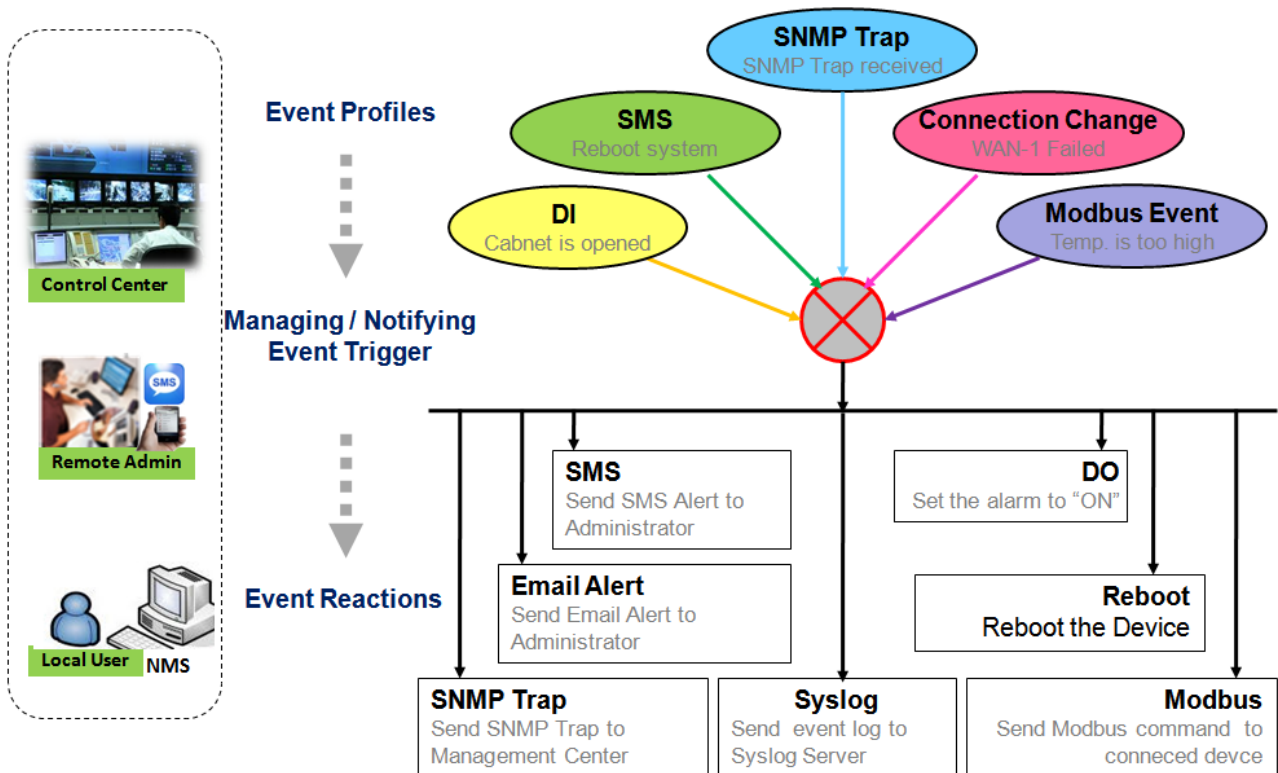

For ease of configuration, administrator can create and edit the common pre-defined managing / notifying event profiles for taking instant reaction on a certain event or managing the devices for some advanced useful purposes. For example, sending/receiving remote managing SMS for the gateway's routine maintaining, the

4G Vehicle Gateway

field bus device status monitoring, digital sensors detection controlling, and so on. All of such management and notification function can be realized effectively via the Event Handling feature.

The following is the summary lists for the provided profiles, and events:

(Note: The available profiles and events could be different for the purchased product.)

- Profiles (Rules):
 - SMS Configuration and Accounts
 - Email Accounts
 - Digital Input (DI) profiles
 - Digital Output (DO) profiles
 - Remote Host profiles

- Managing Events:
 - Trigger Type: SMS, SNMP Trap, and Digital Input (DI).
 - Actions: Get the Network Status; or Configure the LAN/VLAN behavior, WIFI behavior, NAT behavior, Firewall behavior, VPN behavior, System Management, Administration, Digital Output behavior, and Remote Host.

- Notifying Events:
 - Trigger Type: Digital Input, Power Change, Connection Change (WAN, LAN & VLAN, WiFi, DDNS), Administration, Modbus, and Data Usage.
 - Actions: Notify the administrator with SMS, Syslog, SNMP Trap or Email Alert; Change the status of connected Digital Output; Sending collected information to Remote Host.

To use the event handling function, First of all, you have to enable the event management setting and configure the event details with the provided profile settings. You can create or edit pre-defined profiles for individual managing / notifying events. The profile settings are separated into several items; they are the SMS Account Definition, Email Service Definition, Digital Input (DI) Profile Configuration, Digital Output (DO) Profile Configuration, and Remote Host Configuration.

Then, you have to configure each managing / notifying event with identifying the event's trigger condition, and the corresponding actions (reaction for the event) for the event. For each event, more than one action can be activated simultaneously.

4G Vehicle Gateway

7.2.1 Configuration

Go to **Service > SMS & Event > Configuration** Tab.

Event handling is the service that allows administrator to setup the pre-defined events, handlers, or response behavior with individual profiles.

Enable Event Management



The screenshot shows a window titled "Configuration" with a table containing one row. The table has two columns: "Item" and "Setting". The "Item" column contains "Event Management" and the "Setting" column contains an unchecked checkbox labeled "Enable".

Item	Setting
Event Management	<input type="checkbox"/> Enable

Configuration Item	Value setting	Description
Event Management	The box is unchecked by default	Check the Enable box to activate the Event Management function.

Enable SMS Management

To use the SMS management function, you have to configure some important settings first.

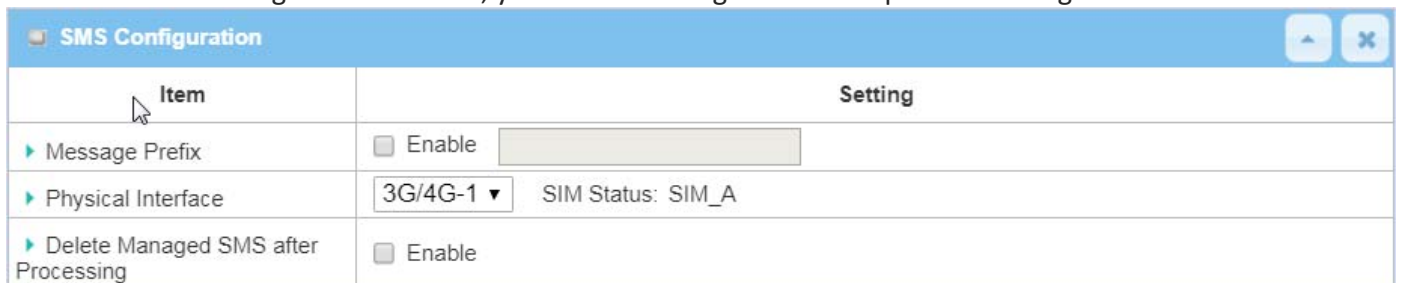

The screenshot shows a window titled "SMS Configuration" with a table containing three rows. The table has two columns: "Item" and "Setting". The "Message Prefix" row has an unchecked "Enable" checkbox and an empty text input field. The "Physical Interface" row has a dropdown menu set to "3G/4G-1" and a "SIM Status: SIM_A" label. The "Delete Managed SMS after Processing" row has an unchecked "Enable" checkbox.

Item	Setting
Message Prefix	<input type="checkbox"/> Enable <input type="text"/>
Physical Interface	3G/4G-1 SIM Status: SIM_A
Delete Managed SMS after Processing	<input type="checkbox"/> Enable

SMS Configuration Item	Value setting	Description
Message Prefix	The box is unchecked by default	Click the Enable box to enable the SMS prefix for validating the received SMS. Once the function is enabled, you have to enter the prefix behind the checkbox. The received managing events SMS must have the designated prefix as an initial identifier, then corresponding handlers will become effective for further processing.

4G Vehicle Gateway

Physical Interface	The box is 3G/4G-1 by default.	Choose a cellular interface (3G/4G-1 or 3G/4G-2) to configure the SMS management setting. Note: 3G/4G-2 is only available for for the product with dual cellular module.
SIM Status	N/A	Show the connected cellular service (identified with SIM_A or SIM_B).
Delete Managed SMS after Processing	The box is unchecked by default	Check the Enable box to delete the received managing event SMS after it has been processed.

Create / Edit SMS Account

Setup the SMS Account for managing the gateway through the SMS. It supports up to a maximum of 5 accounts.

ID	Phone Number	Phone Description	Application	Send confirmed SMS	Enable	Actions
----	--------------	-------------------	-------------	--------------------	--------	---------

You can click the **Add / Edit** button to configure the SMS account.

Item	Setting
▶ Phone Number	Specific Number ▼ <input type="text"/>
▶ Phone Description	<input type="text"/>
▶ Application	<input type="checkbox"/> Event Trigger <input type="checkbox"/> Notify Handle
▶ Send confirmed SMS	<input type="checkbox"/> Enable
▶ Enable	<input checked="" type="checkbox"/> Enable

Item	Value setting	Description
Phone Number	1. Mobile phone number format 2. A Must filled setting	Select the Phone number policy from the drop list, and specify a mobile phone number as the SMS account identifier if required. It can be Specific Number , or Allow Any . If Specific Number is selected, you have to specify the phone number as the SMS account identifier. Value Range: -1 ~ 32 digits.
Phone Description	1. Any text 2. An Optional setting	Specify a brief description for the SMS account.
Application	A Must filled setting	Specify the application type. It could be Event Trigger , Notify Handle , or both . If the Phone Number policy is Allow Any , the Noftify Handle will be unavailable.
Send confirmed SMS	1. An Optional setting 2. The box is unchecked by default.	Click Enable box to active the SMS response function. The gateway will send a confirmed message back to the sender whenever it received a SMS managing event. The confirmed message is similar to following

4G Vehicle Gateway

		format: "Device received a SMS with command xxxxx."
Enable	The box is unchecked by default.	Click Enable box to activate this account.
Save	NA	Click the Save button to save the configuration.

Create / Edit Email Service Account

Setup the Email Service Account for event notification. It supports up to a maximum of 5 accounts.

Email Service List
Add
Delete
▲
✕

ID	Email Server	Email Addresses	Enable	Actions
----	--------------	-----------------	--------	---------

You can click the **Add / Edit** button to configure the Email account.

Email Service Configuration
✕

Item	Setting
▶ Email Server	--- Option --- ▼
▶ Email Addresses	<input style="width: 100%;" type="text"/>
▶ Enable	<input checked="" type="checkbox"/> Enable
<input type="button" value="Save"/>	

Email Service Configuration		
Item	Value setting	Description
Email Server	--- Option ---	Select an Email Server profile from External Server setting for the email account setting.
Email Addresses	1. Internet E-mail address format 2. A Must filled setting	Specify the Destination Email Addresses.
Enable	The box is unchecked by default.	Click Enable box to activate this account.
Save	NA	Click the Save button to save the configuration

4G Vehicle Gateway

Create / Edit Digital Input (DI) Profile Rule (DI/DO support required)

Setup the Digital Input (DI) Profile rules. It supports up to a maximum of 10 profiles.

Digital Input (DI) Profile List								
ID	DI Profile Name	Description	DI Source	Continues Update Status	Normal Level	Signal Active Time (s)	Enable	Actions

When **Add** button is applied, the **Digital Input (DI) Profile Configuration** screen will appear.

Digital Input (DI) Profile Configuration	
Item	Setting
▶ DI Profile Name	<input type="text"/>
▶ Description	<input type="text"/>
▶ DI Source	ID1 ▾
▶ Continues Update Status	<input type="checkbox"/> Enable & Update Interval <input type="text" value="2"/> (2~86400 seconds)
▶ Normal Level	Low ▾
▶ Signal Active Time	<input type="text" value="1"/> (seconds)
▶ Profile	<input checked="" type="checkbox"/> Enable
<input type="button" value="Save"/>	

Digital Input (DI) Profile Configuration		
Item	Value setting	Description
DI Profile Name	1. String format 2. A Must filled setting	Specify the DI Profile Name. Value Range: -1 ~ 32 characters.
Description	1. Any text 2. An Optional setting	Specify a brief description for the profile.
DI Source	ID1 by default	Specify the DI Source. It could be ID1 or ID2 . The number of available DI source could be different for the purchased product.
Continue Update Status	The box is unchecked by default.	Click Enable box to activate this function for the DI event with designated update interval setting. If the event condition keeps active for a long time interval, the gateway will send repeated notify events for each check interval. Value Range: 2 ~ 86400 seconds. Note : To prevent receiving too much notify event for the same situation, you can adjust the check interval to a proper one for your application.
Normal Level	Low by default	Specify the Normal Level. It could be Low or High .
Signal Active Time	1. Numeric String format 2. A Must filled setting	Specify the Signal Active Time. It could be from 1 to 10 seconds. The Signal Active Time setting will be ignored when 'Continue Update Status' function is enabled Value Range: 1 ~ 10 seconds.
Profile	The box is unchecked by	Click Enable box to activate this profile setting.

4G Vehicle Gateway

	default.	
Save	NA	Click the Save button to save the configuration.

Create / Edit Digital Output (DO) Profile Rule (DI/DO support required)

Setup the Digital Output (DO) Profile rules. It supports up to a maximum of 10 profiles.

ID	DO Profile Name	Description	DO Source	Normal Level	Total Signal Period (ms)	Repeat & Counter	Duty Cycle(%)	Enable	Actions
----	-----------------	-------------	-----------	--------------	--------------------------	------------------	---------------	--------	---------

When **Add** button is applied, the **Digital Output (DO) Profile Configuration** screen will appear.

Item	Setting
▶ DO Profile Name	<input type="text"/>
▶ Description	<input type="text"/>
▶ DO Source	ID1 ▾
▶ Normal Level	Low ▾
▶ Total Signal Period	10 <input type="text"/> (ms)
▶ Repeat & Counter	<input type="checkbox"/> Enable & Counter: <input type="text" value="0"/>
▶ Duty Cycle	<input type="text"/> (%)
▶ Profile	<input checked="" type="checkbox"/> Enable
<input type="button" value="Save"/>	

Digital Output (DO) Profile Configuration		
Item	Value setting	Description
DO Profile Name	1. String format 2. A Must filled setting	Specify the DO Profile Name. Value Range: -1 ~ 32 characters.
Description	1. Any text 2. An Optional setting	Specify a brief description for the profile.
DO Source	ID1 by default	Specify the DO Source. It could be ID1.
Normal Level	Low by default	Specify the Normal Level. It could be Low or High .
Total Signal Period	1. Numeric String format 2. A Must filled setting	Specify the Total Signal Period. Value Range: 10 ~ 120000 ms.
Repeat & Counter	The box is unchecked by default.	Check the Enable box to activate the repeated Digital Output, and specify the Repeat times. Value Range: 0 ~ 65535.
Duty Cycle	1. Numeric String format 2. A Must filled setting	Specify the Duty Cycle for the Digital Output. Value Range: 1 ~100 %.
Profile	The box is unchecked by default.	Click Enable box to activate this profile setting.
Save	N/A	Click the Save button to save the configuration.

4G Vehicle Gateway

Create / Edit Remote Host Profile

Setup the Remote Host Profile. It supports up to a maximum of 10 profiles.

Remote Host List								↑	×
ID	Host Name	Host IP	Protocol Type	Port Number	Prefix Message	Suffix Message	Enable	Actions	

You can click the **Add / Edit** button to configure the profile.

Remote Host Configuration		×
Item	Setting	
▶ Host Name	<input type="text"/>	
▶ Host IP	<input type="text"/>	
▶ Protocol Type	TCP ▼	
▶ Port Number	<input type="text"/>	
▶ Prefix Message	<input type="text"/>	
▶ Suffix Message	<input type="text"/>	
▶ Enable	<input type="checkbox"/>	
Save		

Remote Host Configuration		
Item	Value setting	Description
Host Name	1. String format 2. A Must filled setting	Specify the Remote Host profile name. Value Range: -1 ~ 64 characters.
Host IP	1. A Must filled setting 2. IP Address format.	Specify the IP address for the Remote Host. IPv4 Format.
Protocol Type	1. A Must filled setting 2. TCP is selected by default	Specify the protocol to access the Remote Host. It could be TCP or UDP .
Port Number	1. A Must filled setting	Specify the Port number for accessing the Remote Host. Value Range: 1 ~ 65535.
Prefix Message	1. String format 2. An Optional filled setting	Specify the Prefix Message string as pre-defined identification for accessing the remote host, if required. Value Range: -1 ~ 64 characters.
Suffix Message	1. String format 2. An Optional filled setting	Specify the Suffix Message string as pre-defined identification for accessing the remote host, if required. Value Range: -1 ~ 64 characters.
Enable	The box is unchecked by default.	Click Enable box to activate this profile setting.
Save	NA	Click the Save button to save the configuration

4G Vehicle Gateway

Undo

NA

Click the **Undo** button to restore what you just configured back to the previous setting.

4G Vehicle Gateway

7.2.2 Managing Events

Managing Events allow administrator to define the relationship (rule) among event trigger, handlers and response.

Go to **Service > SMS & Event > Managing Events Tab**.

Enable Managing Events



The screenshot shows a configuration window titled 'Configuration'. It contains a table with two columns: 'Item' and 'Setting'. The 'Managing Events' item is listed with an unchecked 'Enable' checkbox.

Item	Setting
Managing Events	<input type="checkbox"/> Enable

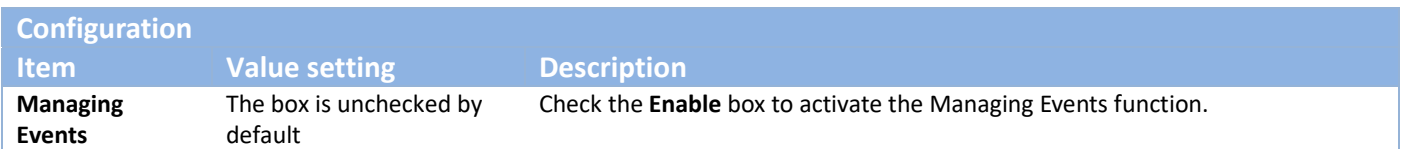

The screenshot shows a configuration window titled 'Configuration'. It contains a table with three columns: 'Item', 'Value setting', and 'Description'. The 'Managing Events' item is listed with the value 'The box is unchecked by default' and the description 'Check the **Enable** box to activate the Managing Events function.'

Item	Value setting	Description
Managing Events	The box is unchecked by default	Check the Enable box to activate the Managing Events function.

Create / Edit Managing Event Rules

Setup the Managing Event rules. It supports up to a maximum of 128 rules.



The screenshot shows a window titled 'Managing Event List' with 'Add' and 'Delete' buttons. It contains a table with columns: ID, Event Name, Event, Trigger Type, Description, Enable, and Actions.

ID	Event Name	Event	Trigger Type	Description	Enable	Actions
----	------------	-------	--------------	-------------	--------	---------

When **Add** or **Edit** button is applied, the **Managing Event Configuration** screen will appear.

4G Vehicle Gateway

Managing Event Configuration	
Item	Setting
▶ Event Name	<input type="text"/>
▶ Event	None ▼ None ▼ None ▼
▶ Trigger Type	Period ▼
▶ Interval	<input type="text" value="0"/> (0~86400 seconds)
▶ Description	<input type="text"/>
▶ Action	<input type="checkbox"/> Network Status <input type="checkbox"/> WAN <input type="checkbox"/> LAN&VLAN <input type="checkbox"/> WiFi <input type="checkbox"/> NAT <input type="checkbox"/> Firewall <input type="checkbox"/> VPN <input type="checkbox"/> GRE <input type="checkbox"/> System Manage <input type="checkbox"/> Administration <input type="checkbox"/> Digital Output <input type="checkbox"/> Remote Host
▶ Managing Event	<input checked="" type="checkbox"/> Enable

Managing Event Configuration		
Item	Value setting	Description
Event	None by default	<p>Specify the Event type (SMS, SNMP Trap, or Digital Input) and an event identifier / profile. Up to 3 event conditions can be specified for defining an event, and the event will be triggered when all the conditions hold simultaneously (AND relation).</p> <p>The supported Event types could be: SMS: Select SMS and fill the message in the textbox to as the trigger condition for the event; SNMP: Select SNMP Trap and fill the message in the textbox to specify SNMP Trap Event; Digital Input: Select Digital Input and a DI profile you defined to specify a certain Digital Input Event;</p> <p><i>Note: The available Event Type could be different for the purchased product.</i></p>
Trigger Type	Period is selected by default	<p>Specify the type of event trigger, either Period or Once. Period: Select Period and specify a time interval, the event will be repeatedly triggered on every time interval when the specified event condition holds. Once: Select Once and the event will be just triggered just one time when the specified event condition holds.</p>
Interval	0 is set by default	Specify the repeatedly event trigger time interval.

4G Vehicle Gateway

		<u>Value Range:</u> 0 ~86400 seconds.
Description	String format : any text.	Enter a brief description for the Managing Event.
Action	All box is unchecked by default.	<p>Specify Network Status, or at least one rest action to take when the expected event is triggered.</p> <p>Network Status: Select Network Status Checkbox to get the network status as the action for the event;</p> <p>LAN&VLAN: Select LAN&VLAN Checkbox and the interested sub-items (Port link On/Off), the gateway will change the settings as the action for the event;</p> <p>WiFi: Select WiFi Checkbox and the interested sub-items (WiFi radio On/Off), the gateway will change the settings as the action for the event;</p> <p>NAT: Select NAT Checkbox and the interested sub-items (Virtual Server Rule On/Off, DMZ On/Off), the gateway will change the settings as the action for the event;</p> <p>Firewall: Select Firewall Checkbox and the interested sub-items (Remote Administrator Host ID On/Off), the gateway will change the settings as the action for the event;</p> <p>VPN: Select VPN Checkbox and the interested sub-items (IPSec Tunnel ON/Off, PPTP Client On/Off, L2TP Client On/Off, OpenVPN Client On/Off), the gateway will change the settings as the action for the event;</p> <p>GRE: Select GRE Checkbox and the interested sub-items (GRE Tunnel On/Off), the gateway will change the settings as the action for the event;</p> <p>System Manage: Select System Manage Checkbox and the interested sub-items (WAN SSH Service On/Off, TR-069 On/Off), the gateway will change the settings as the action for the event;</p> <p>Administration: Select Administration Checkbox and the interested sub-items (Backup Config, Restore Config, Reboot, Save Current Setting as Default), the gateway will change the settings as the action for the event;</p> <p>Digital Output: Select Digital Output checkbox and a DO profile you defined as the action for the event;</p> <p>Remote Host: Select Remote Host checkbox and a Remote Host profile you defined as the action for the event;</p> <p><i>Note: The available Event Type could be different for the purchased product.</i></p>
Managing Event	The box is unchecked by default.	Click Enable box to activate this Managing Event setting.
Save	NA	Click the Save button to save the configuration
Undo	NA	Click the Undo button to restore what you just configured back to the previous setting.

4G Vehicle Gateway

7.2.3 Notifying Events

Go to **Service > SMS & Event > Notifying Events** Tab.

Notifying Events Setting allows administrator to define the relationship (rule) between event trigger and handlers.

Enable Notifying Events

Configuration	
Item	Setting
▶ Notifying Events	<input checked="" type="checkbox"/> Enable

Configuration Item	Value setting	Description
Notifying Events	The box is unchecked by default	Check the Enable box to activate the Notifying Events function.

Create / Edit Notifying Event Rules

Setup your Notifying Event rules. It supports up to a maximum of 128 rules.

Notifying Event List								
ID	Event Name	Event	Trigger Type	Description	Action	Time Schedule	Enable	Actions

When **Add** or **Edit** button is applied, the **Notifying Event Configuration** screen will appear.

Notifying Event Configuration	
Item	Setting
▶ Event Name	<input type="text"/>
▶ Event	None ▾ and None ▾ and None ▾
▶ Trigger Type	Period ▾
▶ Interval	0 (0~86400 seconds)
▶ Description	<input type="text"/>

4G Vehicle Gateway

▶ Delay to send	<input type="text"/> (0~3600 seconds)
▶ Action	<input type="checkbox"/> Digital Output <input type="checkbox"/> SMS <input type="checkbox"/> Syslog <input type="checkbox"/> SNMP Trap (Only Support v1 and v2c) <input type="checkbox"/> Email Alert <input type="checkbox"/> Remote Host <input type="checkbox"/> System
▶ Time Schedule	(0) Always ▼
▶ Notifying Events	<input checked="" type="checkbox"/> Enable
<input type="button" value="Save"/>	

Notifying Event Configuration		
Item	Value setting	Description
Event Name	Blank by default	Specify a name or identifier for this notifying event rule. Value Range: 0 ~ 64 characters.
Event	None by default	Specify the Event type and corresponding event configuration. Up to 3 event conditions can be specified for defining an event, and the event will be triggered when all the conditions hold simultaneously (AND relation). The supported Event Type could be: Digital Input: Select Digital Input and a DI profile you defined to specify a certain Digital Input Event; Power Change: Select Power Change and a trigger condition to specify the event on a certain power source. WAN: Select WAN and a trigger condition to specify a certain WAN Event; LAN&VLAN: Select LAN&VLAN and a trigger condition to specify a certain LAN&VLAN Event; WiFi: Select WiFi and a trigger condition to specify a certain WiFi Event; DDNS: Select DDNS and a trigger condition to specify a certain DDNS Event; Administration: Select Administration and a trigger condition to specify a certain Administration Event; Data Usage: Select Data Usage , the SIM Card (Cellular Service) and a trigger condition to specify a certain Data Usage Event; <i>Note: The available Event Type could be different for the purchased product.</i>
Trigger Type	Period is selected by default	Specify the type of event trigger, either Period or Once . Period: Select Period and specify a time interval, the event will be repeatedly triggered on every time interval when the specified event condition holds. Once: Select Once and the event will be just triggered just one time when the specified event condition holds.
Interval	0 is set by default	Specify the repeatedly event trigger time interval. Value Range: 0 ~86400 seconds.
Description	String format : any text.	Enter a brief description for the Notifying Event.
Delay to Send	Blank by default	Specify a delay time, if required, to send out the notifying event once it had been triggered.

4G Vehicle Gateway

		<u>Value Range:</u> 0 ~3600 seconds.
Action	All box is unchecked by default.	Specify at least one action to take when the expected event is triggered. Digital Output: Select Digital Output checkbox and a DO profile you defined as the action for the event; SMS: Select SMS , and the gateway will send out a SMS to all the defined SMS accounts as the action for the event; Syslog: Select Syslog and select/unselect the Enable Checkbox to as the action for the event; SNMP Trap: Select SNMP Trap , and the gateway will send out SNMP Trap to the defined SNMP Event Receivers as the action for the event; Email Alert: Select Email Alert , and the gateway will send out an Email to the defined Email accounts as the action for the event; Remote Host: Select Remote Host checkbox and a Remote Host profile you defined as the action for the event;
		<i>Note: The available Event Type could be different for the purchased product.</i>
Time Schedule	(0) Always is selected by default	Select a time scheduling rule for the Notifying Event.
Notifying Events	The box is unchecked by default.	Click Enable box to activate this Notifying Event setting.
Save	NA	Click the Save button to save the configuration
Undo	NA	Click the Undo button to restore what you just configured back to the previous setting.

4G Vehicle Gateway

7.3 Location Tracking

Location tracking applications are usually referred to applications that take benefits from Global Navigation Satellite System (GNSS). GNSS is the infrastructure that allows devices to determine its position, velocity, and time by processing satellites signals from outer space. GNSS includes varieties of satellite systems and Satellite-Based Augmentation Systems (SBAS). SBAS is usually used for improving positioning accuracy. The tables below show 4 major GNSS system in the world, and SBAS system in different areas.

Major GNSS System in the world

GNSS System	Owner
GPS	USA
GLONASS	Russia
Galileo	European Union
BeiDou (COMPASS)	China

Satellite-Based Augmentation System (SBAS)

SBAS	Area Coverage
EGNOS	Europe
WAAS	North America
GAGAN	India
MSAS	Japan

Position applications are widely-used by varieties of industrial applications, including Location-Based Services (LBS), Automatic Vehicle Location (AVL), Fleet Management, or assets tracking. However, in most case, GNSS is a one-way communication. That means GNSS-compatible device can only locate its location by receiving GNSS signal, but it can't forward its location data to any other identity through GNSS system. According to this limitation by GNSS system, devices usually need to equip other technology to transmit their location data to back-end server for track or further analysis. Furthermore, as the position applications are more applied on moving objects, a kind of wireless technology would be more suitable to be adopted to transmit location data. Nowadays, thanks to popularity and wide coverage of cellular technology (GSM, 3G, 4G/LTE), transmitting location data to remote center in real time is no longer a hurdle. In addition, the data format of location data is NMEA 0183 compatible, so the back-end server will be easy to interpret the collected location data.

Hereunder are the main features of GNSS function in cellulargateway, if optional GNSS function is supported.

4G Vehicle Gateway

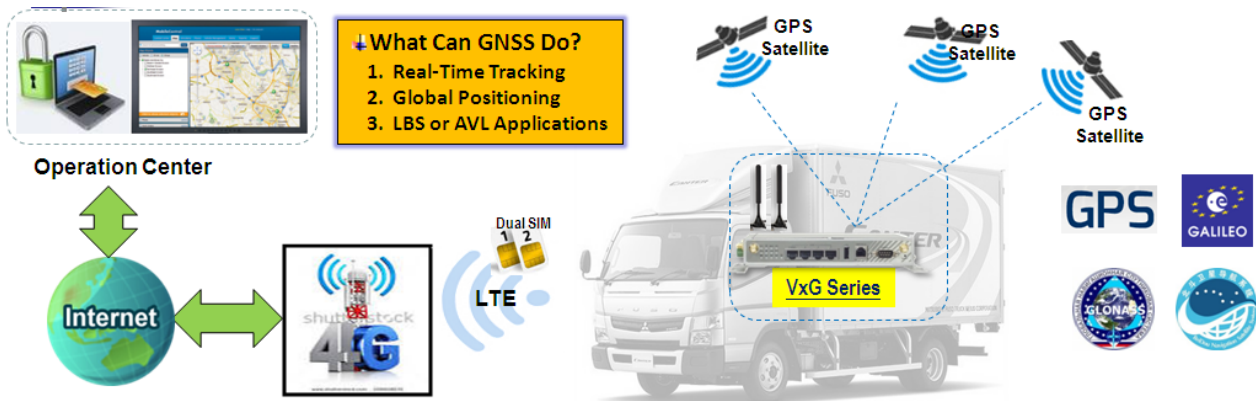

- Retrieve GNSS data from satellites and send to remote operation center periodically or save in local storage.
- Global positioning with multiple GNSS systems, including GPS, and optional for GLONASS, Galileo, or BeiDou.
- Mandatory for varieties of LBS (Location-Based Service) applications, such as advertisement, emergent call.
- Easy integration with AVL (Automatic Vehicle Location) applications, for managing fleet of service vehicles.
- Other value-added applications, such as asset tracking, electronic toll collection, intelligent transport system.

7.3.1 GNSS

With GNSS configuration page, you can configure those functions that are mentioned above. Please note the available GNSS features on different models may be different. Please check product datasheet for details.

The configuration steps include following items.

- Activate GNSS feature in gateway and finish settings of cellular WAN.
- Support NMEA 0183 (compatible to 3.0) protocol, and allow customized prefix and suffix.
- Configurable GPS data logging on local microSD card storage for route record tracking.
- Indicate remote host, time interval, TCP/UDP, and type of GPS data that would be sent.

● GPS Message Type

This item shows all supported types of NMEA 0183 data format. NMEA 0183 data format was defined and maintained by National Marine Electronics Association (NMEA). Select one or more types that you want to use for transmitting GPS data. In most case, this configuration depends on which data format that your central server can recognize. Only select the type you need, otherwise it will consume unnecessary network bandwidth. The table below shows more information for different types of NMEA 0183 message.

Type	Description	Example
GGA	Fix Information	\$GPGGA,123519,4807.038,N,01131.000,E,1,08,0.9,545.4,M,46.9,M,,*47
GLL	Lat/Lon Data	\$GPGLL,4916.45,N,12311.12,W,225444,A,*1D

4G Vehicle Gateway

GSA	Overall Satellite Data	\$GPGSA,A,3,04,05,,09,12,,,24,,,,,2.5,1.3,2.1*39
GSV	Detailed Satellite Data	\$GPGSV,2,1,08,01,40,083,46,02,17,308,41,12,07,344,39,14,22,228,45*75
RMC	Recommended Minimum Data	\$GPRMC,123519,A,4807.038,N,01131.000,E,022.4,084.4,230394,003.1,W*6A
VTG	Vector Track and Speed Over the Ground	\$GPVTG,054.7,T,034.4,M,005.5,N,010.2,K*48

Please note this option is hardware dependent. The available options of GPS message type show on this page is according to product specification. You may not see all options if your product doesn't support all of them.

● SBAS

SBAS is Satellite-Based Augmentation Systems that is used to improve accuracy of location data. There are several SBAS systems for different areas in the world.

SBAS	Area Coverage
EGNOS	Europe
WAAS	North America
GAGAN	India
MSAS	Japan

Please note this option is hardware dependent. You may not see this option if your product doesn't support it.

● Assisted GPS

Assisted GPS (as known as A-GPS) is used for speeding up location fix, especially when satellite signal is weak. If activating this option, gateway will download almanac data from A-GPS server through IP network instead of from satellite. You can also choose different valid period of almanac data. The shorter almanac data will get higher accuracy. However, the almanac data with shorter valid period needs to be updated more frequently. It will consume more network bandwidth. Please note this option is hardware dependent. You may not see this option if your product doesn't support it.

● Data to Storage

Besides transmitting location data to remote server, you can also store location data into internal storage (e.g. microSD card) or external storage (e.g. USB drive) if any. Regarding to data format, either can be NMEA 0183 raw data format or save it as GPX file format. The location data will be saved to a new file if the original file size is bigger than the pre-defined file size. The "Download log file" button allows you to browse all saved log files and download to your personal devices.

4G Vehicle Gateway

➤ Scenario of location tracking for fleet management

A fleet owner would like to see the locations of his trucks in real time. He also likes to know where his trucks have been passed through with time information. In his operation office, there is a server (IP: 100.100.100.1) which can interpret NMEA RMC data format and shows truck's location and track on map. This server is listening on TCP port 888 to receive NMEA RMC packet from trucks. IMEI number will be added before NMEA RMC data for identification of each truck. Hereunder is the configuration on each truck.

Basic Settings:

Configuration Path	[GNSS]-[Configuration]
GNSS	<i>Enable</i>
GNSS Type	<i>GPS</i>
GPS Message Types	<i>RMC</i>
SBAS	<i>Enable</i>
Assisted GPS	<i>Enable, 1</i>
Data to Storage	<i>Disable</i>

Settings for Remote Host:

Configuration Path	[GNSS]-[Remote Host Configuration]
Host Name	<i>Truck-1</i>
Host IP	<i>100.100.100.1</i>
Protocol Type	<i>TCP</i>
Port Number	<i>888</i>
Interval(s)	<i>15</i>
Prefix Message	<i>123456789012345</i>
Suffix Message	<i>[blank]</i>
Enable Checkbox	<i>[Checked]</i>

4G Vehicle Gateway

GNSS Setting

Go to **Service>Location Tracking> GNSS** Tab.

The GNSS allows user to set the configuration of GNSS, log NMEA data to storage, and send data to remote host. Ensure GNSS is enabled and saved

Setup GNSS Configuration

Configuration
⏪ ⏩

Item	Setting
▶ GNSS	<input checked="" type="checkbox"/> Enable
▶ GNSS Type	GPS ▼
▶ GNSS Message Types	<input checked="" type="checkbox"/> RMC
▶ Assisted GPS	<input checked="" type="checkbox"/> Enable
▶ Data to Storage	<input type="checkbox"/> Enable Select Device: Internal ▼ Interval: 5 (s) Data format: RAW ▼ Data file name: <input style="width: 200px;" type="text"/> Split file: <input type="checkbox"/> Enable Size: 200 KB ▼ <input type="button" value="Download log file"/> <input type="button" value="Delete log file"/>

GNSS Configuration		
Item	Value setting	Description
GNSS Enable	The box is unchecked by default	Check Enable box to activate GNSS functions.
GNSS Type	GPS is selected by default	Select a GNSS Type (GNSS System) that you want to use. Please note this option is hardware dependent. The available options of GNSS type show on this page is according to product specification. You may not see all of these four options if your product doesn't support all of them.
GNSS Message Types	These box is unchecked by default.	Select one or more GNSS Message Types that you want to use for transmitting or recording GPS data. There are many sentences in the NMEA standard for selecting, GGA, GLL, GSA, GSV, RMC and VTG . ALL Other includes DTM, GNS, GRS, GST, ZDA, and GBS sentences. Only select the type you need, otherwise it will consume unnecessary network bandwidth. Note: The supported message type is hardware dependent.
SBAS	The box is unchecked by default	Check Enable box to activate satellite-based augmentation system (SBAS). Note: Some devices do not support this function.
Assisted GPS	The box is checked by	Check Enable box to activate Assisted GPS (A-GPS).

4G Vehicle Gateway

	default	Select the duration for downloading the Differential Almanac Corrections data from A-GPS server through IP network. Note: Some devices may not support this function.
Data to Storage	The box is unchecked by default	<ul style="list-style-type: none"> ● Enable (The box is unchecked by default) Check Enable box to activate data to storage function. ● Select Device (A Must filled setting) Select Internal or External device to store log data. ● Interval (A Must filled setting) Specify the time interval between two continuous data log. By default, 5 second is set. <i>Value Range: 5 ~ 60 seconds.</i> ● Data Format (A Must filled setting) Select data format (RAW, or GPX) to store. ● Data file name (A Must filled setting) Define file name to store. ● Split Enable Check Enable box to activate file splitting function. ● Split Size & Unit Define file size and unit for log file. By default, 200 KB is defined. <i>Value Range: >= 10KB (Minimum file size is 10 KB).</i> ● Download log file Select a log file and Click Download log file to download through Web GUI. If the log format which is specified to download is GPX, we will convert standard GPX format for used.
Save	NA	Click the Save button to save the configuration

Create / Edit Remote Host

The Remote Host allows you to customize your rules for sending NMEA data to specific IP address and Port. The router supports up to a maximum of 10 rule sets.

ID	Host Name	Host IP	Protocol Type	Port Number	Interval(s)	Prefix Message	Suffix Message	Enable	Actions
----	-----------	---------	---------------	-------------	-------------	----------------	----------------	--------	---------

When **Add** button is applied, **Remote Host Configuration** screen will appear.

4G Vehicle Gateway

Remote Host Configuration	
Item	Setting
▶ Host Name	<input type="text"/>
▶ Host IP	<input type="text"/>
▶ Protocol Type	TCP ▼
▶ Port Number	<input type="text"/>
▶ Interval(s)	<input type="text" value="1"/>
▶ Prefix Message	<input type="text"/>
▶ Suffix Message	<input type="text"/>
▶ Enable	<input type="checkbox"/>

Remote Host Configuration		
Item	Value setting	Description
Host Name	String format: any text	Enter the host name for the designated remote host. Value Range: -1 ~ 64 characters.
Host IP	A Must filled setting	Specify the IP Address of remote host. It will be use as destination IP for sending NMEA packets.
Protocol Type	TCP is selected by default	Specify the Protocol (TCP or UDP) to use for sending NMEA packets.
Port Number	A Must filled setting	Specify a Port Number as destination port for sending NMEA packets. Value Range: 1 ~ 65535.
Interval(s)	A Must filled setting	Specify the time interval (seconds) between two NMEA packets. Value Range: 1 ~255 seconds.
Prefix Message	String format: any text	Specify optional prefix string with specific information if your backend server can recognize. For example, you can input the IMEI code of this device here, and then your backend server can recognize this GPS data is sent from this device. You can also leave this field blank.
Suffix Message	String format: any text	Specify optional suffix string with specific information if your backend server can recognize.
Enable	The box is unchecked by default	Check Enable box to activate this remote host rule.
Save	NA	Click the Save button to save the configuration

4G Vehicle Gateway

7.3.2 Track Viewer

Track Viewer allows user to see the track in Google Map from GPX file recorded by GNSS. In addition, when GNSS is enabled, current position will also be displayed in Track Viewer.

Go to **Service > Location Tracking > Track Viewer Tab**.

Setup Google Maps API Key

When user uses Track Viewer for the first time, UI will request Google Maps API key from user.

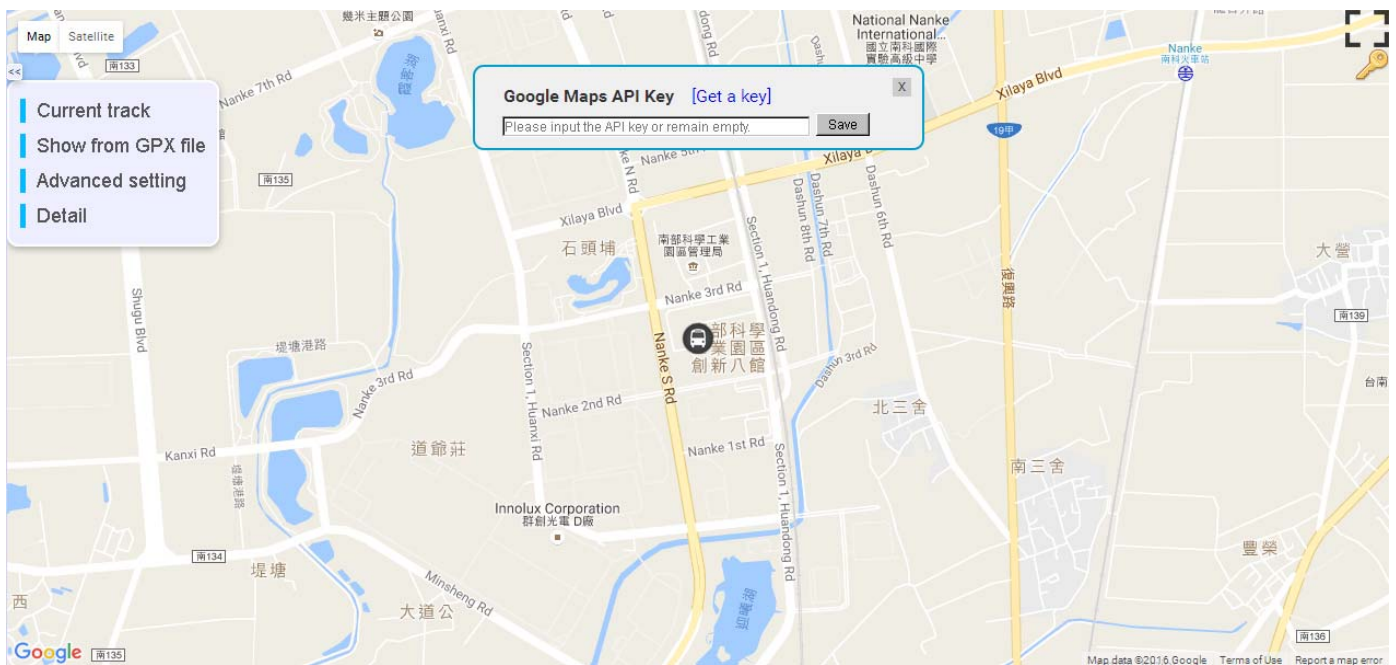

Google Maps API key		
Item	Value setting	Description
Google Maps API Key	An Optional setting.	The Track Viewer function is implemented with Google Maps JavaScript API, and it requires authentication for further operation. If you don't have Google Maps API key, click the link at [Get a key] to get a key from Google. Paste API key on the text box, and then click Save . You can choose to remain it empty and then click X directly. It can let you use the map temporarily. The key icon on the right top will appear until you input the API key.
Save	N/A	Click the Save button to use the API key and reload the page immediately.

If user enters the right key, the key input window and key icon on the right top side will disappear. If user enters an invalid key, UI will prompt the message and request user to change the value of the API key.

4G Vehicle Gateway

If user remains empty in the field of Google Maps API key and clicks “Save”, user can load and use Google map normally. However, we can’t guarantee the number of loading times user can reach if you don’t input the API key.

General Functions

Track Viewer lists following items in the side bar.

General Functions		
Item	Value setting	Description
Current Track	N/A	Show current position and current track on the map. Update interval is 5 seconds. If GNSS is disabled, Current Track button will be hidden.
Show from GPX file	N/A	Show the track from the GPX file. It can choose the file from either internal or external storage.
Advanced setting	N/A	User can set track color, line width, minimum distance, and API key here.
Detail	N/A	Select the Detail function to show a time-speed graph and information of the track.

Show Current Track

When **Current Track** button is clicked, then the following screen will appear.

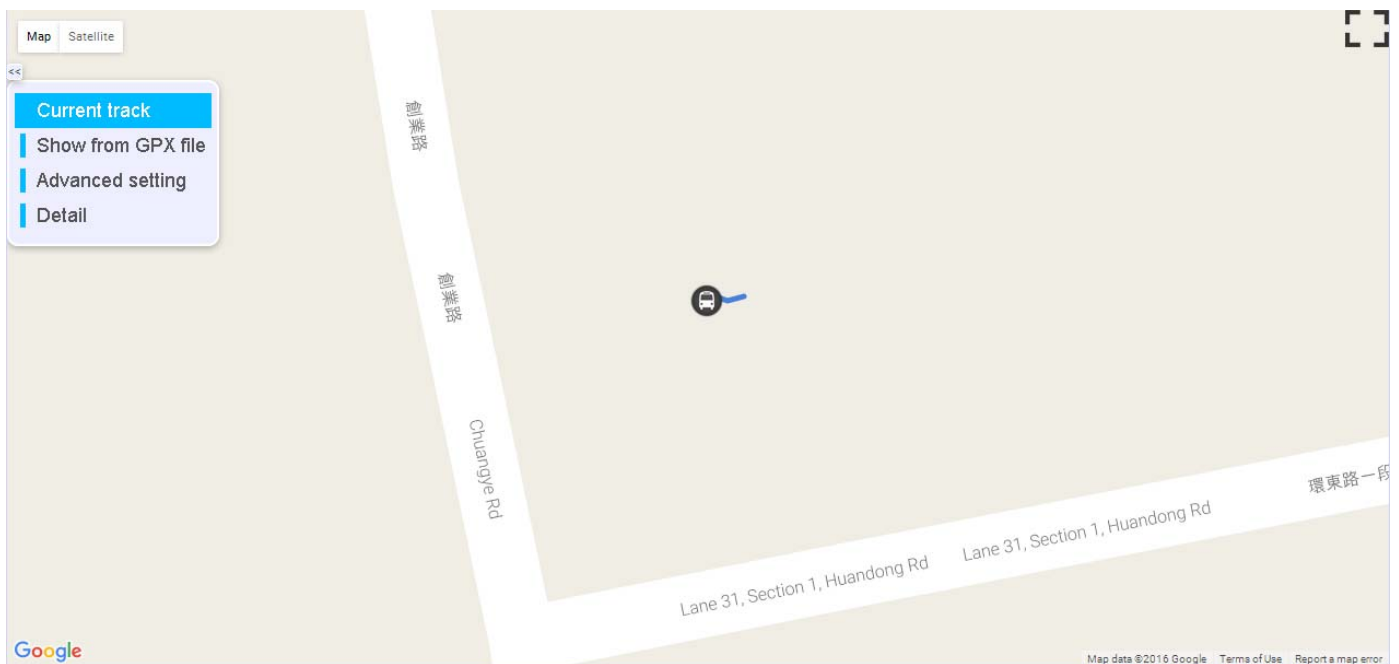

The bus icon indicates the current position of the device (or the vehicle that equipped with the device). Current track is drawn from the time page was loaded to current time.

4G Vehicle Gateway

Show from GPX File

When **Show from GPX file** button is clicked, then the following screen will appear.

Show from GPX file	
Item	Setting
▶ From	<input type="radio"/> Internal <input checked="" type="radio"/> External
▶ GPX file	GPX_1234.gpx

Show from GPX file		
Item	Value setting	Description
From	1. A Must filled setting. 2. Internal is selected by default.	Specify the storage where the GPX file located. It can be Internal or External , it depends on the storage setting in GNSS page. Note: External is disabled when no USB flash drive is detected.
GPX file	1. A Must filled setting.	Select the expected GPX file from the dropdown list.
Apply	N/A	Click the Apply button to load the GPX file.
Close	N/A	Click the Close button and the Show from GPX file screen will disappear.

Configure Advanced Setting

When **Advanced setting** button is clicked then applied screen will appear.

Advanced setting	
Item	Setting
▶ Track color	#0055D3
▶ Line width	5 (1-32)
▶ Minimum distance	0 (0-100)
▶ API Key	Change

Advanced Setting		
Item	Value setting	Description
Track color	1. A Must filled setting. 2. #0000FF is set by default.	Change the color of the track. The default value is #0000FF (Blue). Format: #□□□□□□ / #□□□□ / color names e.g. #0000FF, #00F, blue
Line width	1. A Must filled setting. 2. 5 is set by default.	Change the line width of the track. Range is from 1 to 32.
Minimum Distance	1. A Must filled setting. 2. 10 is set by default.	Set the minimum distance between two continuous points. Range is from 0 to 100. When the number is larger, the redundant points are eliminated and the number of points on the map becomes less.
API key	N/A	Click the Change button to modify Google Maps API key.
Apply	N/A	Click the Apply button to apply the setting.
Close	N/A	Click the Close button and the Advanced Setting screen will disappear.

4G Vehicle Gateway

Show Detail

When **Detail** button is clicked, then the following screen will appear.

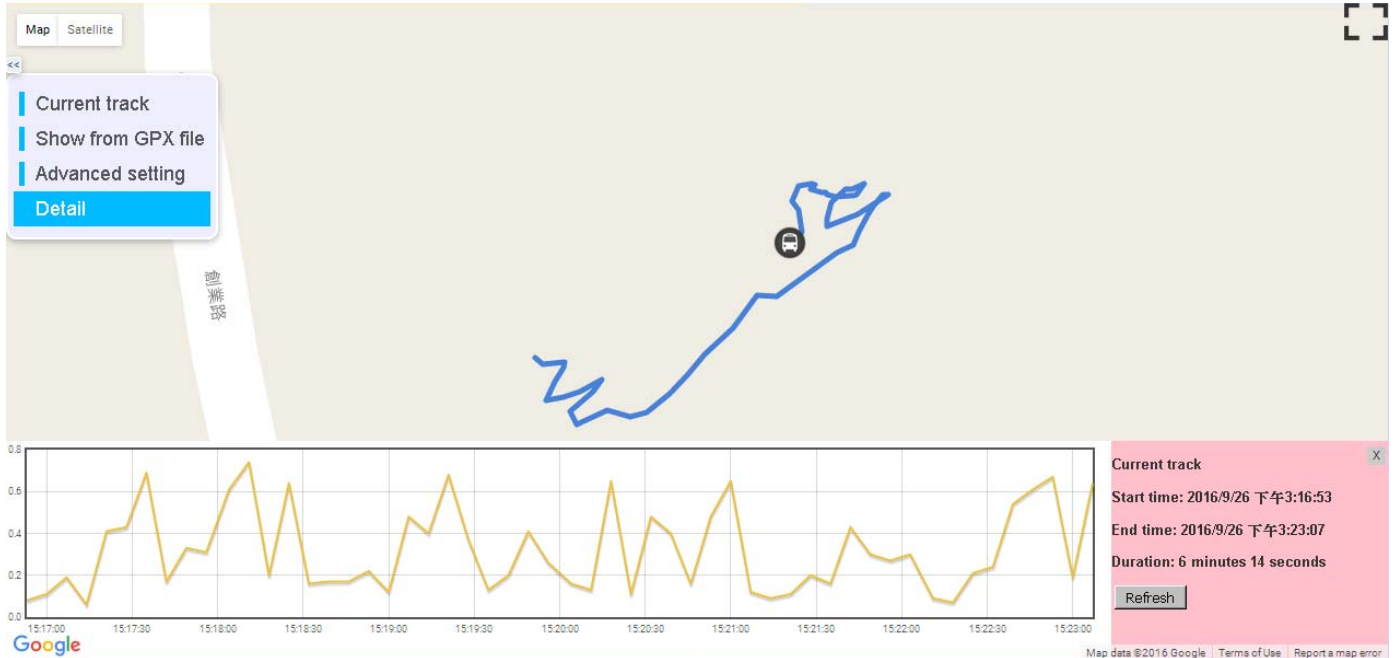

Detail		
Item	Value setting	Description
File name	N/A	Show the file name of current used GPX file. Showing the text Current Track if the map loads current track instead of GPX file.
Start time	N/A	Show the time of the start position. Time format depends on locale.
End time	N/A	Show the time of the end position. Time format depends on locale.
Duration	N/A	Show the time difference between Start time and End time. Format: ? years ? months ? days ? hours ? minutes ? seconds, hide the unit when '?'=0
Refresh	N/A	Only showing the button when the map loads current track. Click Refresh button to refresh the information of the track and update the time-speed graph immediately.
Time-speed graph	N/A	When mouse is over the curve in time-speed graph, the small text box will show the locale time and speed in that point and the yellow car icon will locate on the position at that timestamp in the map. When user clicks the mouse on the point of curve in time-speed graph, it will set the center point of the map to that position.

4G Vehicle Gateway

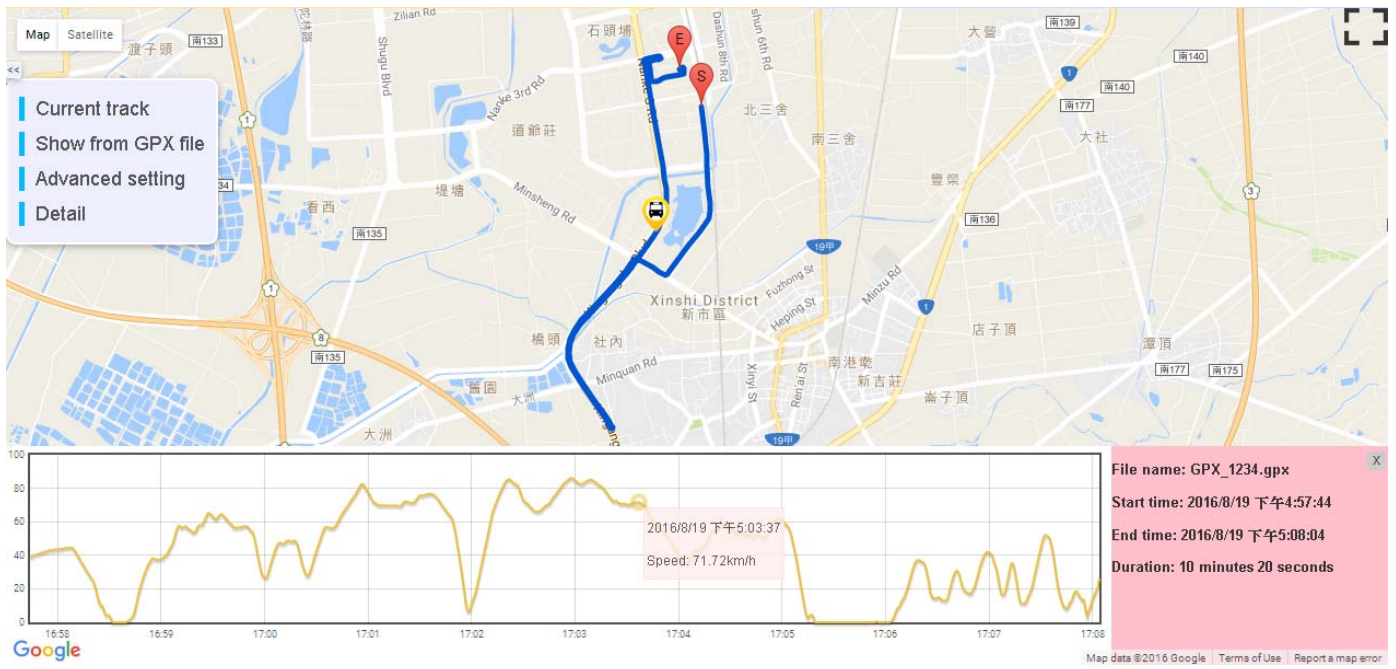

4G Vehicle Gateway

7.4 Power Control

In Power Control section, the device may support Ignition Sense function for In-vehicle gateway products, or Power Outlet control function for the products supporting external PDU function. With such kind of power control function, you can easily setup the gateway to properly operate with the external power source supplying from a vehicle battery, or manage the external device's ON/OFF with a remote PDU.

7.4.1 Ignition Sense

In most cases, the in-vehicle electronic devices will be shut down when car engine is off, but in some occasions you may need devices continue to work. An obvious problem is the power supply to almost all in-vehicle devices will be terminated when car engine is off to prevent in-vehicle devices draining out battery power. To have a solution for this situation, the In-Vehicle Cellular Gateway has been equipped with Ignition Sense function. The main advantages of this feature are:

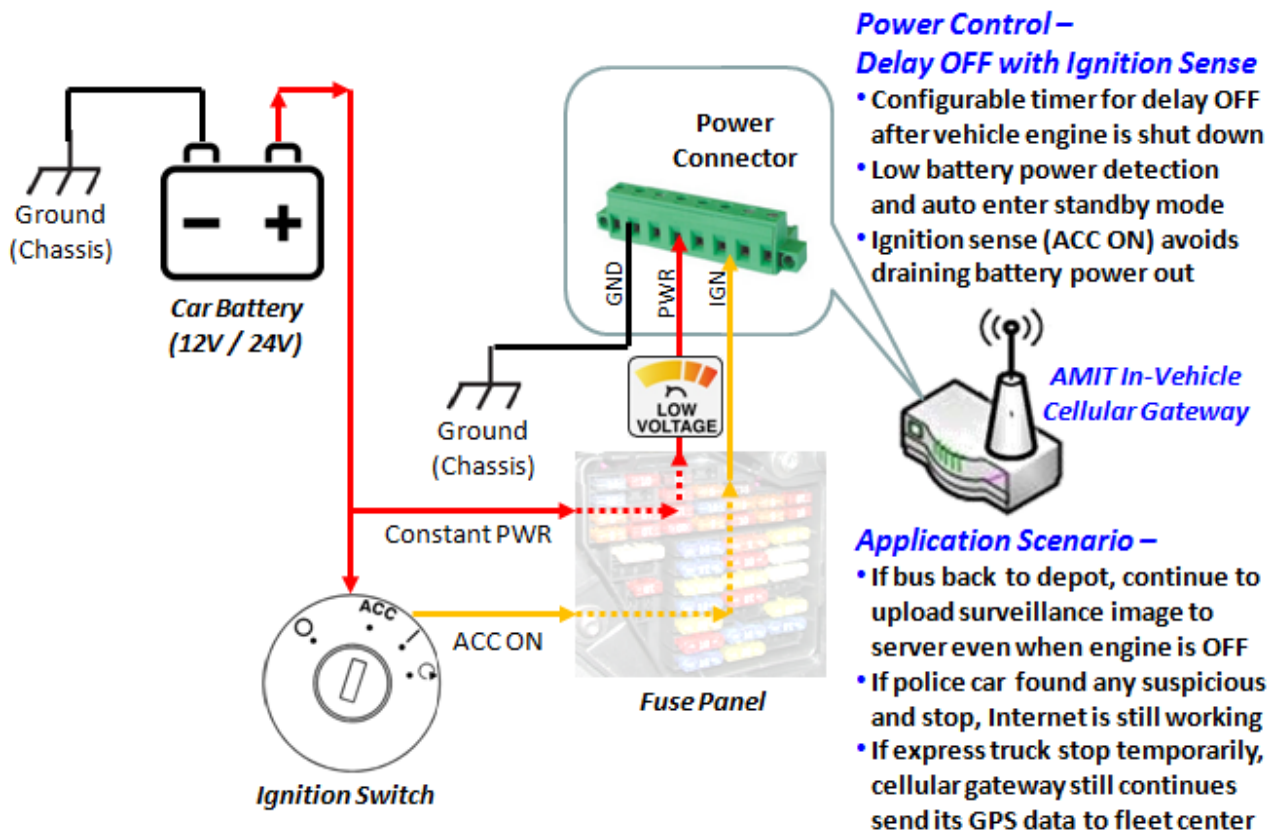

- Cellular gateway can continue to operate when car engine is shut down.
- Cellular gateway will enter standby mode automatically when a pre-set timer is due. If in standby mode, gateway would stop consuming battery power to prevent draining power out.

4G Vehicle Gateway

- Cellular gateway would enter standby mode automatically if lower input power voltage is detected.
- Cellular gateway will be back from standby mode to operation mode when car is started.

Delay Off and Low Power Detection

Configuration	
Item	Setting
▶ Ignition Sense	<input type="checkbox"/> Enable
▶ Shutdown Timer	0 (0~240 minutes)
▶ Voltage Sense	<input type="checkbox"/> Enable
▶ Shutdown Voltage Threshold	9 (volts) (Range:9V-36V)



Ignition Sense Settings

- Ignition Sense: Enable
- Shutdown Timer: 15
- Voltage Sense: Enable
- Shutdown Voltage Threshold: 22

In this example, the surveillance system on buse will transmit video files back to back-end server when buse is back to depot. Driver will shut the bus off and leave bus once bus is parked in depot, but the uplink connection for surveillance system still needs to be available until all video files are completely uploaded. Usually, video files on each bus can be uploaded completely within **15** minutes. To prevent draining out battery power, bus driver activates low voltage detection function to force gateway to be shut down if battery voltage is down to **22V**. (regular voltage is 24V)

4G Vehicle Gateway

Ignition Sense Setting

Go to **Service > Power Control > Ignition Sense Tab**.

With Ignition Sense configuration page, you can configure those functions that are mentioned above. Please note this feature is only available on specific models. Please check product datasheet for details.

ATTENTION

The ignition sense feature is disabled by default. Once this feature is enabled, this gateway won't power on until power from ignition pin of terminal block is detected (ACC ON).

Configuration	
Item	Setting
▶ Ignition Sense	<input type="checkbox"/> Enable
▶ Shutdown Timer	<input type="text" value="0"/> (0~240 minutes)
▶ Voltage Sense	<input type="checkbox"/> Enable
▶ Shutdown Voltage Threshold	<input type="text" value="9"/> (volts) (Range:9V-36V)

Configuration		
Item	Value setting	Description
Ignition Sense	The box is unchecked by default.	Click Enable box to activate this Ignition Sense function. By default, the function is disabled, and the gateway will be always ON when Power Source is attached.
Shutdown Timer	1.Number format : any number between 0 and 240. 2. 0 is set by default.	Enter a shutdown timer (0~240 minutes) to shutdown the power of the gateway after the engine has been stopped '0' means the gateway will never been shutdown even if ignition is removed (ACC OFF). Value Range: 0 ~ 240.
Voltage Sense	The box is unchecked by default.	Click Enable box to activate this Voltage Sense function. If the function is enabled, when input voltage is under the specified threshold value, the gateway will be shut down when ACC is OFF, no matter shutdown timer is due or not.
Shutdown Voltage Threshold	An optional setting.	Specify a threshold voltage to shut down the gateway when low battery power situation happens. Value Range: 9V ~ 36V.
Save	N/A	Click the Save button to save the configuration
Undo	N/A	Click the Undo button to restore what you just configured back to the previous setting.

Chapter 8 Status

8.1 Dashboard

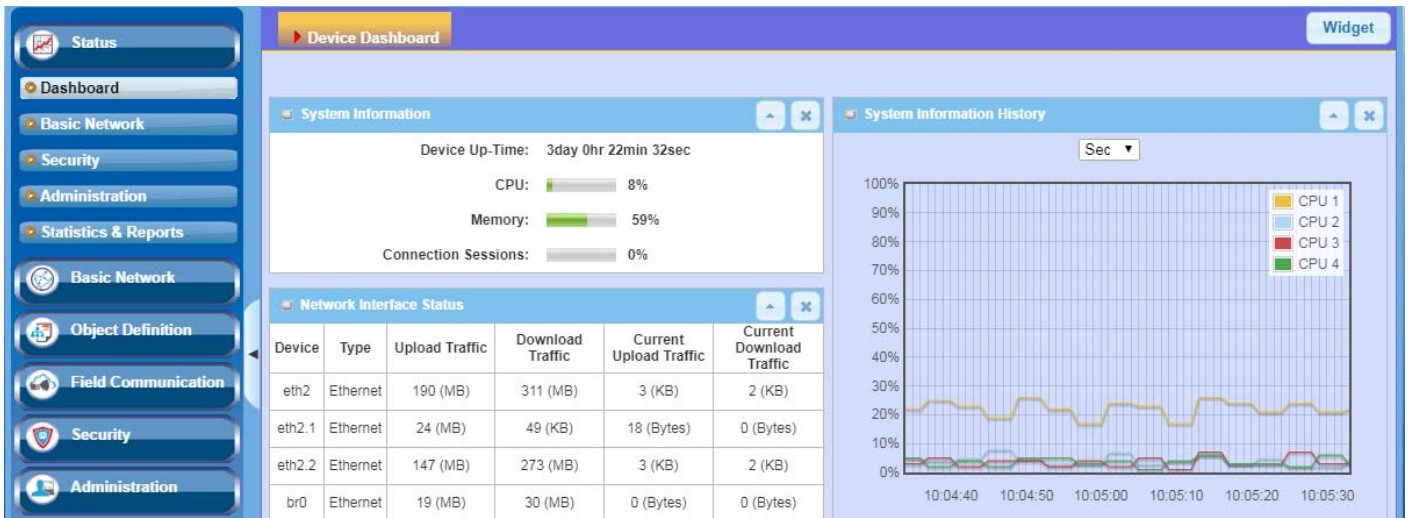

8.1.1 Device Dashboard

The **Device Dashboard** window shows the current status in graph or tables for quickly understanding the operation status for the gateway. They are the System Information, System Information History, and Network Interface Status. The display will be refreshed once per second.

From the menu on the left, select **Status > Dashboard > Device Dashboard** tab.

System Information Status

The **System Information** screen shows the device Up-time and the resource utilization for the CPU, Memory, and Connection Sessions.

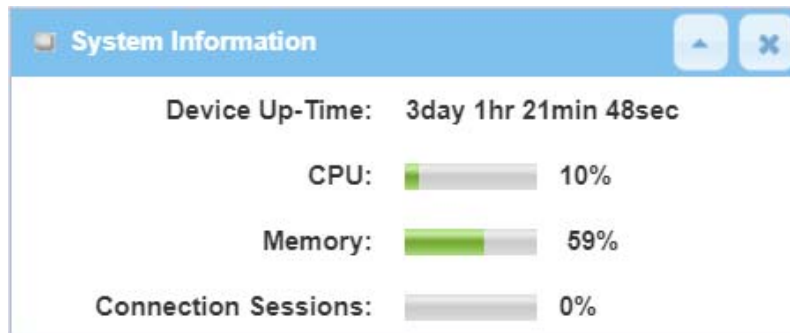

4G Vehicle Gateway

System Information History

The **System Information History** screen shows the statistic graphs for the CPU and memory.

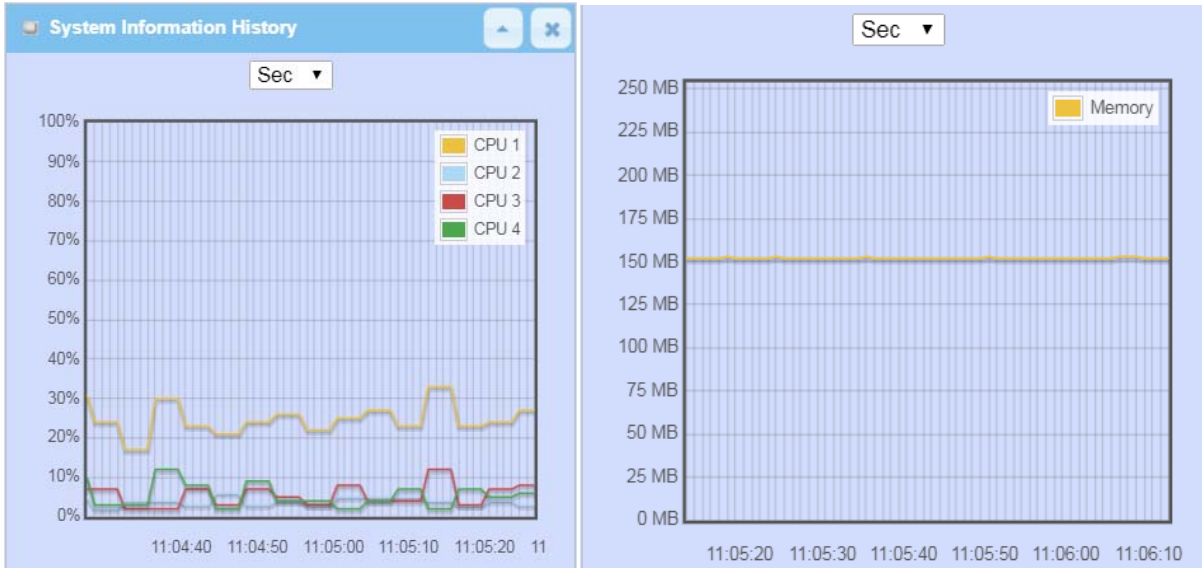

Network Interface Status

The **Network Interface Status** screen shows the statistic information for each network interface of the gateway. The statistic information includes the Interface Type, Upload Traffic, Download Traffic, and Current Upload / Download Traffic.

Device	Type	Upload Traffic	Download Traffic	Current Upload Traffic	Current Download Traffic
eth2	Ethernet	211 (MB)	321 (MB)	3 (KB)	3 (KB)
eth2.1	Ethernet	24 (MB)	71 (KB)	64 (Bytes)	0 (Bytes)
eth2.2	Ethernet	168 (MB)	283 (MB)	3 (KB)	3 (KB)
br0	Ethernet	19 (MB)	31 (MB)	42 (Bytes)	0 (Bytes)
ra0	Wireless LAN	1 (MB)	1 (MB)	0 (Bytes)	0 (Bytes)
rai0	Wireless LAN	21 (MB)	42 (MB)	0 (Bytes)	0 (Bytes)
ra1	Wireless LAN	0 (Bytes)	0 (Bytes)	0 (Bytes)	0 (Bytes)
rai1	Wireless LAN	362 (Bytes)	4 (KB)	0 (Bytes)	0 (Bytes)
tun0	Ethernet	0 (Bytes)	0 (Bytes)	0 (Bytes)	0 (Bytes)

4G Vehicle Gateway

8.2 Basic Network

8.2.1 WAN & Uplink Status

Go to **Status > Basic Network > WAN & Uplink** tab.

The **WAN & Uplink Status** window shows the current status for different network type, including network configuration, connecting information, modem status and traffic statistics. The display will be refreshed on every five seconds.

WAN interface IPv4 Network Status

WAN interface IPv4 Network Status screen shows status information for IPv4 network.

WAN Interface IPv4 Network Status										
ID	Interface	WAN Type	Network Type	IP Addr.	Subnet Mask	Gateway	DNS	MAC Address	Conn. Status	Action
WAN-1	3G/4G	3G/4G	NAT	10.59.152.73	255.255.255.252	10.59.152.74	168.95.1.1, 168.95.192.1	N/A	Connected 0 day 0:26:38	Edit
WAN-2		Disable								Edit

WAN interface IPv4 Network Status		
Item	Value setting	Description
ID	N/A	It displays corresponding WAN interface WAN IDs.
Interface	N/A	It displays the type of WAN physical interface. Depending on the model purchased, it can be Ethernet, 3G/4G, or WiFi Uplink.
WAN Type	N/A	It displays the method which public IP address is obtained from your ISP. Depending on the model purchased, it can be Static IP, Dynamic IP, PPPoE, PPTP, L2TP, 3G/4G.
Network Type	N/A	It displays the network type for the WAN interface(s). Depending on the model purchased, it can be NAT, Routing, Bridge, or IP Pass-through.
IP Addr.	N/A	It displays the public IP address obtained from your ISP for Internet connection. Default value is 0.0.0.0 if left unconfigured.
Subnet Mask	N/A	It displays the Subnet Mask for public IP address obtained from your ISP for Internet connection. Default value is 0.0.0.0 if left unconfigured.
Gateway	N/A	It displays the Gateway IP address obtained from your ISP for Internet connection. Default value is 0.0.0.0 if left unconfigured.
DNS	N/A	It displays the IP address of DNS server obtained from your ISP for Internet connection. Default value is 0.0.0.0 if left unconfigured.
MAC Address	N/A	It displays the MAC Address for your ISP to allow you for Internet access. Note: Not all ISP may require this field.
Conn. Status	N/A	It displays the connection status of the device to your ISP. Status are Connected or disconnected.

4G Vehicle Gateway

Action	N/A	<p>This area provides functional buttons.</p> <p>Renew button allows user to force the device to request an IP address from the DHCP server. Note: Renew button is available when DHCP WAN Type is used and WAN connection is disconnected.</p> <p>Release button allows user to force the device to clear its IP address setting to disconnect from DHCP server. Note: Release button is available when DHCP WAN Type is used and WAN connection is connected.</p> <p>Connect button allows user to manually connect the device to the Internet. Note: Connect button is available when Connection Control in WAN Type setting is set to Connect Manually (Refer to Edit button in Basic Network > WAN & Uplink > Internet Setup) and WAN connection status is disconnected.</p> <p>Disconnect button allows user to manually disconnect the device from the Internet. Note: Connect button is available when Connection Control in WAN Type setting is set to Connect Manually (Refer to Edit button in Basic Network > WAN & Uplink > Internet Setup) and WAN connection status is connected.</p>
---------------	-----	---

WAN interface IPv6 Network Status

WAN interface IPv6 Network Status screen shows status information for IPv6 network.

WAN Interface IPv6 Network Status						
ID	Interface	WAN type	Link-local IP Address	Global IP Address	Conn. Status	Action
WAN-1	3G/4G	IPv6		/64	Disconnected	<input type="button" value="Edit"/>

WAN interface IPv6 Network Status		
Item	Value setting	Description
ID	N/A	It displays corresponding WAN interface WAN IDs.
Interface	N/A	It displays the type of WAN physical interface. Depending on the model purchased, it can be Ethernet, 3G/4G, etc...
WAN Type	N/A	It displays the method which public IP address is obtained from your ISP. WAN type setting can be changed from Basic Network > IPv6 > Configuration .
Link-local IP Address	N/A	It displays the LAN IPv6 Link-Local address.
Global IP Address	N/A	It displays the IPv6 global IP address assigned by your ISP for your Internet connection.
Conn. Status	N/A	It displays the connection status. The status can be connected, disconnected and connecting.
Action	N/A	This area provides functional buttons. Edit Button when pressed, web-based utility will take you to the IPv6 configuration page. (Basic Network > IPv6 > Configuration .)

4G Vehicle Gateway

LAN Interface Network Status

LAN Interface Network Status screen shows IPv4 and IPv6 information of LAN network.

IPv4 Address	IPv4 Subnet Mask	IPv6 Link-local Address	IPv6 Global Address	MAC Address	Action
192.168.66.1	255.255.254.0	fe80::250:18ff:fe3a:4a5f	/64	00:50:18:3A:4A:5F	Edit IPv4 Edit IPv6

Item	Value setting	Description
IPv4 Address	N/A	It displays the current IPv4 IP Address of the gateway This is also the IP Address user use to access Router's Web-based Utility.
IPv4 Subnet Mask	N/A	It displays the current mask of the subnet.
IPv6 Link-local Address	N/A	It displays the current LAN IPv6 Link-Local address. This is also the IPv6 IP Address user use to access Router's Web-based Utility.
IPv6 Global Address	N/A	It displays the current IPv6 global IP address assigned by your ISP for your Internet connection.
MAC Address	N/A	It displays the LAN MAC Address of the gateway
Action	N/A	This area provides functional buttons. Edit IPv4 Button when press, web-based utility will take you to the Ethernet LAN configuration page. (Basic Network > LAN & VLAN > Ethernet LAN tab). Edit IPv6 Button when press, web-based utility will take you to the IPv6 configuration page. (Basic Network > IPv6 > Configuration .)

3G/4G Modem Status

3G/4G Modem Status List screen shows status information for 3G/4G WAN network(s).

Interface	Card Information	Link Status	Signal Strength	Network Name	Action
3G/4G	ZM8620	Connected	70% (-69dBm)	Chunghwa Telecom (LTE)	Detail

Item	Value setting	Description
Physical Interface	N/A	It displays the type of WAN physical interface. Note: Some device model may support two 3G/4G modules. Their physical interface name will be 3G/4G-1 and 3G/4G-2 .
Card Information	N/A	It displays the vendor's 3G/4G modem model name.

4G Vehicle Gateway

Link Status	N/A	It displays the 3G/4G connection status. The status can be Connecting, Connected, Disconnecting, and Disconnected.
Signal Strength	N/A	It displays the 3G/4G wireless signal level.
Network Name	N/A	It displays the name of the service network carrier.
Refresh	N/A	Click the Refresh button to renew the information.
Action	N/A	This area provides functional buttons. Detail Button when press, windows of detail information will appear. They are the Modem Information, SIM Status, and Service Information. Refer to next page for more.

When the **Detail** button is pressed, 3G/4G modem information windows such as Modem Information, SIM Status, Service Information, Signal Strength / Quality, and Error Message will appear.

Interface Traffic Statistics

Interface Traffic Statistics screen displays the Interface's total transmitted packets.

ID	Interface	Received Packets(Mb)	Transmitted Packets(Mb)	Action
WAN-1	3G/4G	217.13	167.09	Reset
WAN-2		-	-	

Item	Value setting	Description
ID	N/A	It displays corresponding WAN interface WAN IDs.
Interface	N/A	It displays the type of WAN physical interface. Depending on the model purchased, it can be Ethernet, 3G/4G, etc...
Received Packets (Mb)	N/A	It displays the downstream packets (Mb). It is reset when the device is rebooted.
Transmitted Packets (Mb)	N/A	It displays the upstream packets (Mb). It is reset when the device is rebooted.

4G Vehicle Gateway

8.2.2 LAN & VLAN Status

Go to **Status > Basic Network > LAN & VLAN** tab.

Client List

The **Client List** shows you the LAN Interface, IP address, Host Name, MAC Address, and Remaining Lease Time of each device that is connected to this gateway.

LAN Client List				
LAN Interface	IP Address	Host Name	MAC Address	Remaining Lease Time
Ethernet	Dynamic / 192.168.66.100	amit25613572	00-13-3B-0E-5B-1D	00:15:00

LAN Client List Item	Value setting	Description
LAN Interface	N/A	Client record of LAN Interface. String Format.
IP Address	N/A	Client record of IP Address Type and the IP Address. Type is String Format and the IP Address is IPv4 Format.
Host Name	N/A	Client record of Host Name. String Format.
MAC Address	N/A	Client record of MAC Address. MAC Address Format.
Remaining Lease Time	N/A	Client record of Remaining Lease Time. Time Format.

4G Vehicle Gateway

8.2.3 WiFi Status

Go to **Status > Basic Network > WiFi** tab.

The **WiFi Status** window shows the overall statistics of WiFi VAP entries.

WiFi Virtual AP List

The WiFi Virtual AP List shows all of the virtual AP information on each WiFi module. The **Edit** button allows for quick configuration changes.

WiFi Module One Virtual AP List									
Op. Band	ID	WiFi Enable	Op. Mode	SSID	Channel	WiFi System	Auth.&Security	MAC Address	Action
2.4G	VAP-1	<input checked="" type="checkbox"/>	WiFi Uplink	Staff_2.4G	1	b/g/n Mixed	WPA2-PSK(AES)	00:50:18:3A:4A:5F	Edit QR Code
2.4G	VAP-2	<input checked="" type="checkbox"/>	WiFi Uplink	default	1	b/g/n Mixed	Open(None)	02:50:18:38:4A:5F	Edit QR Code
2.4G	VAP-3	<input type="checkbox"/>	WiFi Uplink	default	1	b/g/n Mixed	WPA2-PSK(AES)	02:50:18:39:4A:5F	Edit QR Code
2.4G	VAP-4	<input type="checkbox"/>	WiFi Uplink	default	1	b/g/n Mixed	WPA2-PSK(AES)	02:50:18:3A:4A:5F	Edit QR Code
2.4G	VAP-5	<input type="checkbox"/>	WiFi Uplink	default	1	b/g/n Mixed	WPA2-PSK(AES)	02:50:18:3B:4A:5F	Edit QR Code
2.4G	VAP-6	<input type="checkbox"/>	WiFi Uplink	default	1	b/g/n Mixed	WPA2-PSK(AES)	02:50:18:3C:4A:5F	Edit QR Code
2.4G	VAP-7	<input type="checkbox"/>	WiFi Uplink	default	1	b/g/n Mixed	WPA2-PSK(AES)	02:50:18:3D:4A:5F	Edit QR Code

WiFi Virtual AP List		
Item	Value setting	Description
Op. Band	N/A	It displays the Wi-Fi Operation Band (2.4G or 5G) of VAP.
ID	N/A	It displays the ID of VAP.
WiFi Enable	N/A	It displays whether the VAP wireless signal is enabled or disabled.
Op. Mode	N/A	The Wi-Fi Operation Mode of VAP. Depends of device model, modes are AP Router, WDS Only and WDS Hybrid, Universal Repeater and Client.
SSID	N/A	It displays the network ID of VAP.
Channel	N/A	It displays the wireless channel used.
WiFi System	N/A	The WiFi System of VAP.
Auth. & Security	N/A	It displays the authentication and encryption type used.
MAC Address	N/A	It displays MAC Address of VAP.
Action	N/A	Click the Edit button to make a quick access to the WiFi configuration page. (Basic Network > WiFi > Configuration tab) The QR Code button allow you to generate QR code for quick connect to the VAP by scanning the QR code.

4G Vehicle Gateway

WiFi Uplink Status

The WiFi Uplink Status shows all information of connected WiFi uplink network on each WiFi module..

WiFi Module One Uplink Status							
SSID	BSSID	Channel	Security	RSSI0	RSSI1	Rate	Action
Only_For_Monkey	00:00:00:00:00:00	1	WPA2-PSK(AES)	0	0	0	<input type="button" value="Edit"/>

WiFi Module One Uplink Status		
Item	Value setting	Description
SSID	N/A	It displays the network ID of VAP.
BSSID	N/A	It displays the theBSSID for the connected wireless network.
Channel	N/A	It displays the wireless channel used.
Security	N/A	It displays the authentication and encryption setting for the WiFi uplink connection.
RSSI0, RSSI1	N/A	It displays the Rx sensitivity on each radio path..
Rate	N/A	It displays the link rate for the WiFi uplink connection.
Action	N/A	Click the Edit button to make a quick access to the WiFi uplink configuration page. (Basic Network > WAN & Uplink > Internet Setup tab)

WiFi IDS Status

The WiFi IDS Status shows all the WIDS statistics on each WiFi module.

WiFi Module One IDS Status								
Authentication Frame	Association Request Frame	Re-association Request Frame	Probe Request Frame	Disassociation Frame	Deauthentication Frame	EAP Request Frame	Malicious Data Frame	Action
0	0	0	0	0	0	0	0	<input type="button" value="Reset"/>

WiFi IDS Status		
Item	Value setting	Description
Authentication Frame	N/A	It displays the receiving Authentication Frame count.
Association Request Frame	N/A	It displays the receiving Association Request Frame count.
Re-association Request Frame	N/A	It displays the receiving Re-association Request Frame count.
Probe Request Frame	N/A	It displays the receiving Probe Request Frame count.
Disassociation Frame	N/A	It displays the receiving Disassociation Frame count.
Deauthentication Frame	N/A	It displays the receiving Deauthentication Frame count.
EAP Request Frame	N/A	It displays the receiving EAP Request Frame count.
Malicious Data Frame	N/A	It displays the number of receiving unauthorized wireless packets.
Action	N/A	Click the Reset button to clear the entire statistic and reset counter to 0.

4G Vehicle Gateway

Ensure WIDS function is enabled

Go to **Basic Network > WiFi > Advanced Configuration tab**

Note that the WIDS of **2.4GHz** or **5GHz WiFi** should be configured **separately**.

WiFi Traffic Statistic

The WiFi Traffic Statistic shows all the received and transmitted packets on each WiFi module.

WiFi Module One Traffic Statistics				
Op. Band	ID	Received Packets	Transmitted Packets	Action
2.4G	VAP-1	269	80	Reset
2.4G	VAP-2	26	8	Reset
2.4G	VAP-3	0	0	Reset
2.4G	VAP-4	0	0	Reset
2.4G	VAP-5	0	0	Reset
2.4G	VAP-6	0	0	Reset
2.4G	VAP-7	0	0	Reset

WiFi Traffic Statistic		
Item	Value setting	Description
Op. Band	N/A	It displays the Wi-Fi Operation Band (2.4G or 5G) of VAP.
ID	N/A	It displays the VAP ID.
Received Packets	N/A	It displays the number of received packets.
Transmitted Packet	N/A	It displays the number of transmitted packets.
Action	N/A	Click the Reset button to clear individual VAP statistics.
Refresh Button	N/A	Click the Refresh button to update the entire VAP Traffic Statistic instantly.

4G Vehicle Gateway

8.2.4 DDNS Status

Go to **Status > Basic Network > DDNS** tab.

The **DDNS Status** window shows the current DDNS service in use, the last update status, and the last update time to the DDNS service server.

DDNS Status

DDNS Status List				
Host Name	Provider	Effective IP	Last Update Status	Last Update Time

DDNS Status Item	Value Setting	Description
Host Name	N/A	It displays the name you entered to identify DDNS service provider
Provider	N/A	It displays the DDNS server of DDNS service provider
Effective IP	N/A	It displays the public IP address of the device updated to the DDNS server
Last Update Status	N/A	It displays whether the last update of the device public IP address to the DDNS server has been successful (Ok) or failed (Fail).
Last Update Time	N/A	It displays time stamp of the last update of public IP address to the DDNS server.
Refresh	N/A	The refresh button allows user to force the display to refresh information.

4G Vehicle Gateway

8.3 Security

The screenshot shows the VPN Status window with the following data:

IPsec Tunnel Status							
ID	Tunnel Name	Tunnel Scenario	Local Subnets	Remote IP/FQDN	Remote Subnets	Conn. Time	Status
OpenVPN Server Status						Conn. Time	Status
ID	User Name	Remote IP/FQDN	Virtual IP/Mac	Conn. Time	Status		
OpenVPN Client Status							
ID	OpenVPN Client Name	Interface	Remote IP/FQDN	Remote Subnet	Virtual IP	Conn. Time	Conn. Status
1	Master_client	WAN 1	m2mcluster.de	/	172.17.0.190	00:00:00:44	Connected
L2TP Server Status							
ID	User Name	Remote IP	Remote Virtual IP	Remote Call ID	Conn. Time	Status	
L2TP Client Status							
ID	L2TP Client Name	Interface	Virtual IP	Remote IP/FQDN	Default Gateway/Remote Subnet	Conn. Time	Status

8.3.1 VPN Status

Go to **Status > Security > VPN** tab.

The **VPN Status** window shows the overall VPN tunnel status. The display will be refreshed on every five seconds.

IPsec Tunnel Status

IPsec Tunnel Status windows show the configuration for establishing IPsec VPN connection and current connection status.

IPsec Tunnel Status							
ID	Tunnel Name	Tunnel Scenario	Local Subnets	Remote IP/FQDN	Remote Subnets	Conn. Time	Status

Item	Value setting	Description
Tunnel Name	N/A	It displays the tunnel name you have entered to identify.
Tunnel Scenario	N/A	It displays the Tunnel Scenario specified.
Local Subnets	N/A	It displays the Local Subnets specified.

4G Vehicle Gateway

Remote IP/FQDN	N/A	It displays the Remote IP/FQDN specified.
Remote Subnets	N/A	It displays the Remote Subnets specified.
Conn. Time	N/A	It displays the connection time for the IPSec tunnel.
Status	N/A	It displays the Status of the VPN connection. The status displays are Connected, Disconnected, Wait for traffic, and Connecting.
Edit Button	N/A	Click on Edit Button to change IPSec setting, web-based utility will take you to the IPSec configuration page. (Security > VPN > IPSec tab)

OpenVPN Server Status

According to OpenVPN configuration, the **OpenVPN Server/Client Status** shows the status and statistics for the OpenVPN connection from the server side or client side.

OpenVPN Server Status Edit					
ID	User Name	Remote IP/FQDN	Virtual IP/Mac	Conn. Time	Status
OpenVPN Server Status					
Item	Value setting	Description			
User Name	N/A	It displays the Client name you have entered for identification.			
Remote IP/FQDN	N/A	It displays the public IP address (the WAN IP address) of the connected OpenVPN Client			
Virtual IP/MAC	N/A	It displays the virtual IP/MAC address assigned to the connected OpenVPN client.			
Conn. Time	N/A	It displays the connection time for the corresponding OpenVPN tunnel.			
Status	N/A	It displays the connection status of the corresponding OpenVPN tunnel. The status can be Connected, or Disconnected.			

OpenVPN Client Status

OpenVPN Client Status Edit Detail							
ID	OpenVPN Client Name	Interface	Remote IP/FQDN	Remote Subnet	Virtual IP	Conn. Time	Conn. Status
OpenVPN Client Status							
Item	Value setting	Description					
OpenVPN Client Name	N/A	It displays the Client name you have entered for identification.					
Interface	N/A	It displays the WAN interface specified for the OpenVPN client connection.					
Remote IP/FQDN	N/A	It displays the peer OpenVPN Server's Public IP address (the WAN IP address) or FQDN.					
Remote Subnet	N/A	It displays the Remote Subnet specified.					
TUN/TAP Read(bytes)	N/A	It displays the TUN/TAP Read Bytes of OpenVPN Client.					
TUN/TAP Write(bytes)	N/A	It displays the TUN/TAP Write Bytes of OpenVPN Client.					
TCP/UDP	N/A	It displays the TCP/UDP Read Bytes of OpenVPN Client.					

4G Vehicle Gateway

Read(bytes)		
TCP/UDP Write(bytes)	N/A	It displays the TCP/UDP Write Bytes of OpenVPN Client. Connection
Conn. Time	N/A	It displays the connection time for the corresponding OpenVPN tunnel.
Conn. Status	N/A	It displays the connection status of the corresponding OpenVPN tunnel. The status can be Connected, or Disconnected.

4G Vehicle Gateway

L2TP Server/Client Status

L2TP Server/Client Status shows the configuration for establishing L2TP tunnel and current connection status.

L2TP Server Status Edit						
ID	User Name	Remote IP	Remote Virtual IP	Remote Call ID	Conn. Time	Status

L2TP Server Status		
Item	Value setting	Description
User Name	N/A	It displays the login name of the user used for the connection.
Remote IP	N/A	It displays the public IP address (the WAN IP address) of the connected L2TP client.
Remote Virtual IP	N/A	It displays the IP address assigned to the connected L2TP client.
Remote Call ID	N/A	It displays the L2TP client Call ID.
Conn. Time	N/A	It displays the connection time for the L2TP tunnel.
Status	N/A	It displays the Status of each of the L2TP client connection. The status displays Connected, Disconnect, Connecting
Edit	N/A	Click on Edit Button to change L2TP server setting, web-based utility will take you to the L2TP server page. (Security > VPN > L2TP tab)

L2TP Client Status Edit							
ID	L2TP Client Name	Interface	Virtual IP	Remote IP/FQDN	Default Gateway/Remote Subnet	Conn. Time	Status

L2TP Client Status		
Item	Value setting	Description
Client Name	N/A	It displays Name for the L2TP Client specified.
Interface	N/A	It displays the WAN interface with which the gateway will use to request PPTP tunneling connection to the PPTP server.
Virtual IP	N/A	It displays the IP address assigned by Virtual IP server of L2TP server.
Remote IP/FQDN	N/A	It displays the L2TP Server's Public IP address (the WAN IP address) or FQDN.
Default Gateway/Remote Subnet	N/A	It displays the specified IP address of the gateway device used to connect to the internet to connect to the L2TP server –the default gateway. Or other specified subnet if the default gateway is not used to connect to the L2TP server –the remote subnet.
Conn. Time	N/A	It displays the connection time for the L2TP tunnel.
Status	N/A	It displays the Status of the VPN connection. The status displays Connected, Disconnect, and Connecting.
Edit	N/A	Click on Edit Button to change L2TP client setting, web-based utility will take you to the L2TP client page. (Security > VPN > L2TP tab)

4G Vehicle Gateway

PPTP Server/Client Status

PPTP Server/Client Status shows the configuration for establishing PPTP tunnel and current connection status.

PPTP Server Status Edit						
ID	User Name	Remote IP	Remote Virtual IP	Remote Call ID	Conn. Time	Status

PPTP Server Status		
Item	Value setting	Description
User Name	N/A	It displays the login name of the user used for the connection.
Remote IP	N/A	It displays the public IP address (the WAN IP address) of the connected PPTP client.
Remote Virtual IP	N/A	It displays the IP address assigned to the connected PPTP client.
Remote Call ID	N/A	It displays the PPTP client Call ID.
Conn. Time	N/A	It displays the connection time for the PPTP tunnel.
Status	N/A	It displays the Status of each of the PPTP client connection. The status displays Connected, Disconnect, and Connecting.
Edit Button	N/A	Click on Edit Button to change PPTP server setting, web-based utility will take you to the PPTP server page. (Security > VPN > PPTP tab)

PPTP Client Status Edit							
ID	PPTP Client Name	Interface	Virtual IP	Remote IP/FQDN	Default Gateway/Remote Subnet	Conn. Time	Status

PPTP Client Status		
Item	Value setting	Description
Client Name	N/A	It displays Name for the PPTP Client specified.
Interface	N/A	It displays the WAN interface with which the gateway will use to request PPTP tunneling connection to the PPTP server.
Virtual IP	N/A	It displays the IP address assigned by Virtual IP server of PPTP server.
Remote IP/FQDN	N/A	It displays the PPTP Server's Public IP address (the WAN IP address) or FQDN.
Default Gateway / Remote Subnet	N/A	It displays the specified IP address of the gateway device used to connect to the internet to connect to the PPTP server –the default gateway. Or other specified subnet if the default gateway is not used to connect to the PPTP server –the remote subnet.
Conn. Time	N/A	It displays the connection time for the PPTP tunnel.
Status	N/A	It displays the Status of the VPN connection. The status displays Connected, Disconnect, and Connecting.
Edit Button	N/A	Click on Edit Button to change PPTP client setting, web-based utility will take you to the PPTP server page. (Security > VPN > PPTP tab)

4G Vehicle Gateway

8.3.2 Firewall Status

Go to **Status > Security > Firewall Status** Tab.

The **Firewall Status** provides user a quick view of the firewall status and current firewall settings. It also keeps the log history of the dropped packets by the firewall rule policies, and includes the administrator remote login settings specified in the Firewall Options. The display will be refreshed on every five seconds.

By clicking the icon [+], the status table will be expanded to display log history. Clicking the **Edit** button the screen will be switched to the configuration page.

Packet Filter Status

Packet Filters Edit			
Activated Filter Rule	Detected Contents	IP	Time

Packet Filter Status		
Item	Value setting	Description
Activated Filter Rule	N/A	This is the Packet Filter Rule name.
Detected Contents	N/A	This is the logged packet information, including the source IP, destination IP, protocol, and destination port –the TCP or UDP. String format: Source IP to Destination IP : Destination Protocol (TCP or UDP)
IP	N/A	The Source IP (IPv4) of the logged packet.
Time	N/A	The Date and Time stamp of the logged packet. Date & time format. ("Month" "Day" "Hours":"Minutes":"Seconds")

Note: Ensure Packet Filter Log Alert is enabled.

*Refer to **Security > Firewall > Packet Filter** tab. Check Log Alert and save the setting.*

URL Blocking Status

URL Blocking Edit			
Activated Blocking Rule	Blocked URL	IP	Time

URL Blocking Status		
Item	Value setting	Description
Activated Blocking Rule	N/A	This is the URL Blocking Rule name.
Blocked URL	N/A	This is the logged packet information.
IP	N/A	The Source IP (IPv4) of the logged packet.

4G Vehicle Gateway

Time	N/A	The Date and Time stamp of the logged packet. Date & time format. ("Month" "Day" "Hours":"Minutes":"Seconds")
-------------	-----	---

Note: Ensure URL Blocking Log Alert is enabled.

Refer to **Security > Firewall > URL Blocking** tab. Check Log Alert and save the setting.

Web Content Filter Status

Web Content Filters Edit				
Activated Filter Rule		Detected Contents	IP	Time
Web Content Filter Status				
Item	Value setting	Description		
Activated Filter Rule	N/A	Logged packet of the rule name. String format.		
Detected Contents	N/A	Logged packet of the filter rule. String format.		
IP	N/A	Logged packet of the Source IP. IPv4 format.		
Time	N/A	Logged packet of the Date Time. Date time format ("Month" "Day" "Hours":"Minutes":"Seconds")		

Note: Ensure Web Content Filter Log Alert is enabled.

Refer to **Security > Firewall > Web Content Filter** tab. Check Log Alert and save the setting.

MAC Control Status

MAC Control Edit				
Activated Control Rule		Blocked MAC Addresses	IP	Time
MAC Control Status				
Item	Value setting	Description		
Activated Control Rule	N/A	This is the MAC Control Rule name.		
Blocked MAC Addresses	N/A	This is the MAC address of the logged packet.		
IP	N/A	The Source IP (IPv4) of the logged packet.		
Time	N/A	The Date and Time stamp of the logged packet. Date & time format. ("Month" "Day" "Hours":"Minutes":"Seconds")		

Note: Ensure MAC Control Log Alert is enabled.

Refer to **Security > Firewall > MAC Control** tab. Check Log Alert and save the setting.

4G Vehicle Gateway

Application Filters Status

Application Filters			
Edit			
Filtered Application Category	Filtered Application Name	IP	Time
Application Filters Status			
Item	Value setting	Description	
Filtered Application Category	N/A	The name of the Application Category being blocked.	
Filtered Application Name	N/A	The name of the Application being blocked.	
IP	N/A	The Source IP (IPv4) of the logged packet.	
Time	N/A	The Date and Time stamp of the logged packet. Date & time format. ("Month" "Day" "Hours":"Minutes":"Seconds")	

Note: Ensure Application Filter Log Alert is enabled.

Refer to **Security > Firewall > Application Filter** tab. Check Log Alert and save the setting.

IPS Status

IPS			
Edit			
Detected Intrusion		IP	Time
IPS Firewall Status			
Item	Value setting	Description	
Detected Intrusion	N/A	This is the intrusion type of the packets being blocked.	
IP	N/A	The Source IP (IPv4) of the logged packet.	
Time	N/A	The Date and Time stamp of the logged packet. Date & time format. ("Month" "Day" "Hours":"Minutes":"Seconds")	

Note: Ensure IPS Log Alert is enabled.

Refer to **Security > Firewall > IPS** tab. Check Log Alert and save the setting.

4G Vehicle Gateway

Firewall Options Status

Options Edit			
Stealth Mode	SPI	Discard Ping from WAN	Remote Administrator Management
Disable	Disable	Disable	IP: 192.168.121.54, User Name: admin, Time: Apr 1 11:14:54

Firewall Options Status		
Item	Value setting	Description
Stealth Mode	N/A	Enable or Disable setting status of Stealth Mode on Firewall Options. String Format: Disable or Enable
SPI	N/A	Enable or Disable setting status of SPI on Firewall Options. String Format : Disable or Enable
Discard Ping from WAN	N/A	Enable or Disable setting status of Discard Ping from WAN on Firewall Options. String Format: Disable or Enable
Remote Administrator Management	N/A	Enable or Disable setting status of Remote Administrator. If Remote Administrator is enabled, it shows the currently logged in administrator's source IP address and login user name and the login time. Format: IP : "Source IP", User Name: "Login User Name", Time: "Date time" Example: IP: 192.168.127.39, User Name: admin, Time: Mar 3 01:34:13

Note: Ensure Firewall Options Log Alert is enabled.

*Refer to **Security > Firewall > Options** tab. Check Log Alert and save the setting.*

4G Vehicle Gateway

8.4 Administration

8.4.1 Configure & Manage Status

Go to **Status > Administration > Configure & Manage** tab.

The **Configure & Manage Status** window shows the status for managing remote network devices. The type of management available in your device is depended on the device model purchased. The commonly used ones are the SNMP, TR-069, and UPnP. The display will be refreshed on every five seconds.

SNMP Linking Status

SNMP Link Status screen shows the status of current active SNMP connections.



User Name	IP Address	Port	Community	Auth. Mode	Privacy Mode	SNMP Version
-----------	------------	------	-----------	------------	--------------	--------------

SNMP Link Status		
Item	Value setting	Description
User Name	N/A	It displays the user name for authentication. This is only available for SNMP version 3.
IP Address	N/A	It displays the IP address of SNMP manager.
Port	N/A	It displays the port number used to maintain connection with the SNMP manager.
Community	N/A	It displays the community for SNMP version 1 or version 2c only.
Auth. Mode	N/A	It displays the authentication method for SNMP version 3 only.
Privacy Mode	N/A	It displays the privacy mode for version 3 only.
SNMP Version	N/A	It displays the SNMP Version employed.

SNMP Trap Information

SNMP Trap Information screen shows the status of current received SNMP traps.

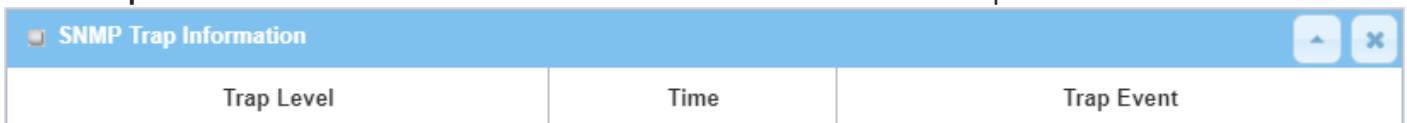

Trap Level	Time	Trap Event
------------	------	------------

SNMP Trap Information		
Item	Value setting	Description
Trap Level	N/A	It displays the trap level.
Time	N/A	It displays the timestamp of trap event.
Trap Event	N/A	It displays the IP address of the trap sender and event type.

4G Vehicle Gateway

TR-069 Status

TR-069 Status screen shows the current connection status with the TR-068 server.

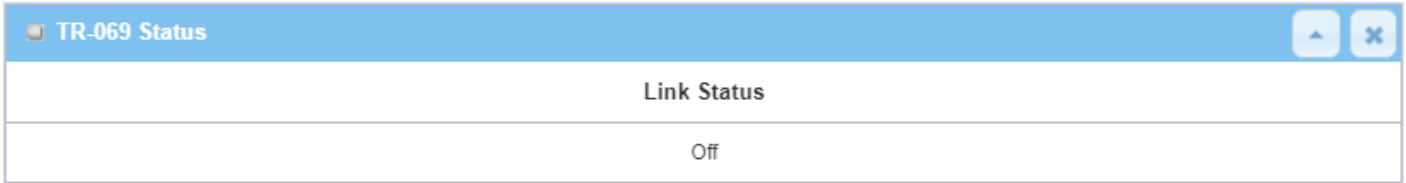

Item	Value setting	Description
Link Status	N/A	It displays the current connection status with the TR-068 server. The connection status is either On when the device is connected with the TR-068 server or Off when disconnected.

4G Vehicle Gateway

8.4.2 Log Storage Status

Go to **Status > Administration > Log Storage** tab.

The **Log Storage Status** screen shows the status for selected device storage.

Log Storage Status

Log Storage Status screen shows the status of current the selected device storage. The status includes Device Description, Usage, File System, Speed, and status.

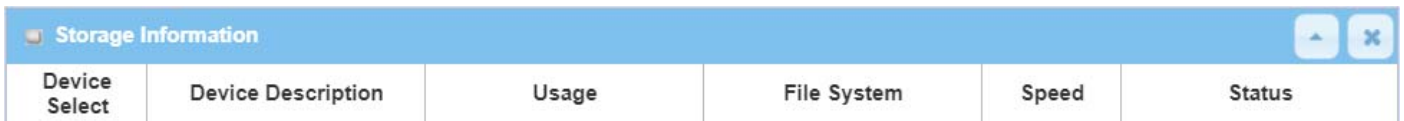

Storage Information					
Device Select	Device Description	Usage	File System	Speed	Status

4G Vehicle Gateway

8.4.3 GNSS Status

Go to **Status > Administration > GNSS** tab.

The **GNSS Information** screen shows the status for current GNSS positioning information for the gateway.



Condition	No. of Satellites	Satellites ID / Signal Strength (dBm)	Position (Lat, Long)	Altitude (meters)	True Course	Ground Speed (km/h)
Not Fixed	0				0	0.00

The available GNSS information includes GNSS Condition, No. of Satellites, Satellites ID / Signal Strength, Position (Lat., Long.), Altitude (meters), True Course, and the equivalent Ground Speed (km/h).

4G Vehicle Gateway

8.5 Statistics & Report

8.5.1 Connection Session

Go to **Status > Statistics & Reports > Connection Session** tab.

Internet Surfing Statistic shows the connection tracks on this router.

Internet Surfing List (14 entries) Previous Next First Last Export (.xml) Export (.csv)					
Refresh					
User Name	Protocol	Internal IP & Port	MAC	External IP & Port	Duration Time
	UDP	192.168.127.58:3847		88.198.95.100:1194	2019/04/01 12:09~
	UDP	192.168.127.58:4486		192.168.123.10:53	2019/04/01 12:09~
	UDP	192.168.127.58:2899		192.168.123.10:53	2019/04/01 12:09~
	UDP	192.168.127.58:1251		192.168.123.10:53	2019/04/01 12:09~
	UDP	192.168.127.58:3145		192.168.123.10:53	2019/04/01 12:09~

Internet Surfing Statistic		
Item	Value setting	Description
Previous	N/A	Click the Previous button; you will see the previous page of track list.
Next	N/A	Click the Next button; you will see the next page of track list.
First	N/A	Click the First button; you will see the first page of track list.
Last	N/A	Click the Last button; you will see the last page of track list.
Export (.xml)	N/A	Click the Export (.xml) button to export the list to xml file.
Export (.csv)	N/A	Click the Export (.csv) button to export the list to csv file.
Refresh	N/A	Click the Refresh button to refresh the list.

4G Vehicle Gateway

8.5.2 Network Traffic

Go to **Status > Statistics & Reports > Network Traffic** tab.

Network Traffic Statistics screen shows the historical graph for the selected network interface.

You can change the interface drop list and select the interface and sampling time interval you want to monitor.

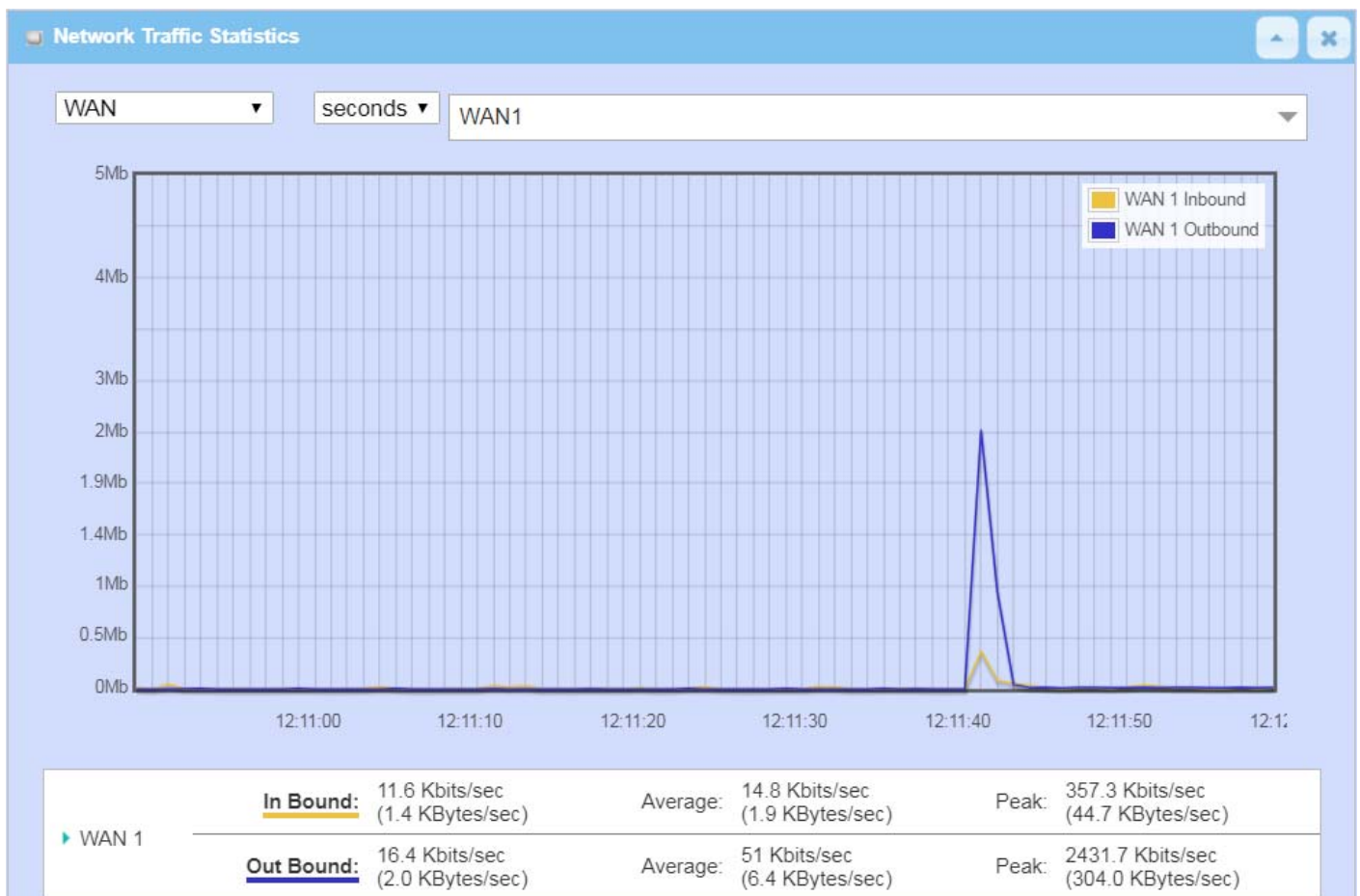

4G Vehicle Gateway

8.5.3 Login Statistics

Go to **Status > Statistics & Reports > Login Statistics**

Login Statistics shows the login information.

Device Manager Login Statistics				
Refresh				
User Name	Protocol Type	IP Address	Info	Duration Time
admin	HTTP	192.168.123.190	Admin	2018/01/01 00:00~
admin	HTTP	192.168.123.190	Admin	2018/01/01 00:02~
admin	HTTP	192.168.123.190	Login Fail	2019/06/05 16:30~
admin	HTTP	192.168.123.190	Admin	2019/06/05 16:30~

Device Manager Login Statistic Item	Value setting	Description
Previous	N/A	Click the Previous button; you will see the previous page of login statistics.
Next	N/A	Click the Next button; you will see the next page of login statistics.
First	N/A	Click the First button; you will see the first page of login statistics.
Last	N/A	Click the Last button; you will see the last page of login statistics.
Export (.xml)	N/A	Click the Export (.xml) button to export the login statistics to xml file.
Export (.csv)	N/A	Click the Export (.csv) button to export the login statistics to csv file.
Refresh	N/A	Click the Refresh button to refresh the login statistics.

4G Vehicle Gateway

8.5.4 Cellular Usage

Go to **Status > Statistics & Reports > Cellular Usage** tab.

Cellular Usage screen shows data usage statistics for the selected cellular interface. The cellular data usage can be accumulated per hour or per day.

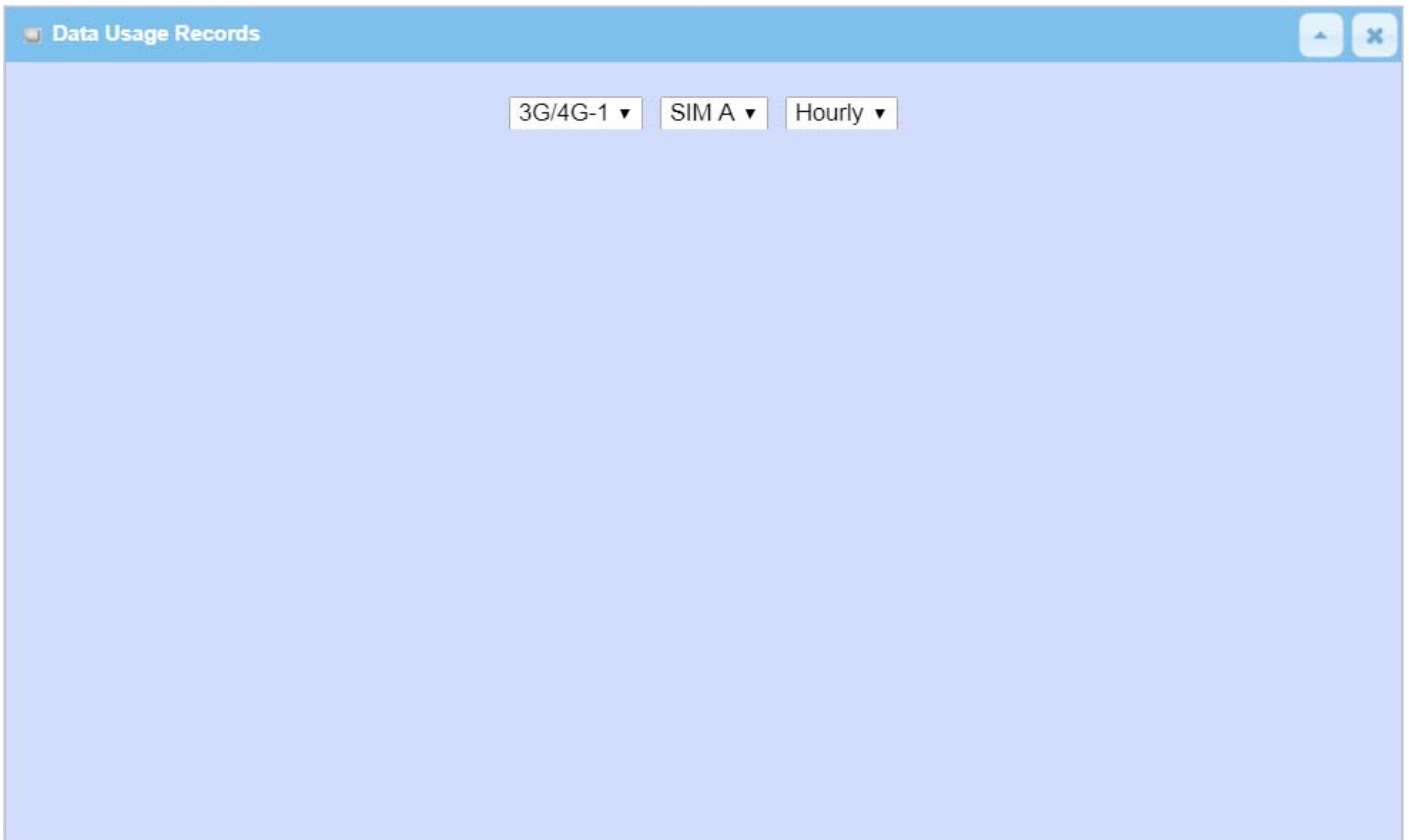

4G Vehicle Gateway

8.5.5 Portal Usage

Go to **Status > Statistics & Reports > Portal Usage** tab.

Portal Usage shows the information about internal Captive Portal user login statistics.

Captive Portal User Login Statistics						
User Name	Status	Create Time	Remaining Lease Time	Time Used	Expiration Time	User Level
<div style="display: flex; justify-content: space-between; align-items: center;"> Captive Portal User Login Statistics Previous Next First Last Refresh </div>						
Item	Value setting	Description				
User Name	N/A	It displays the User Name of user account created in Object Define > User > User Profile .				
Status	N/A	It displays the Status of user account about logging captive portal. Online for the user logged to the captive portal; Offline for the user already logouted.				
Create Time	N/A	It displays the Create Time that user account created.				
Remaining Lease Time	N/A	It displays the Remaining Lease Time of the user account. If the remaining time is zero, the corresponding user account can't be use for login captive portal anymore. If the Lease Time of user account is empty, the remaining lease time field is shown empty. It means that the user account can be used all the time.				
Time Used	N/A	It displays the Time Used since the user login to the captive portal.				
Expiration Time	N/A	It displays the Expiration Time of the user account. Tell user that what time the user account will be useless. If the Lease Time of user account is empty, the expiration time field is also empty. It means that the user account can be used all the time.				
User Leve		It displays the User Level of the user account. It can be Admin, Staff, Guest, and Passenger .				
Previous	N/A	Click the Previous button; you will see the previous page of login statistics.				
Next	N/A	Click the Next button; you will see the next page of login statistics				
First	N/A	Click the First button; you will see the first page of login statistics				
Last	N/A	Click the Last button; you will see the last page of login statistics				
Refresh	N/A	Click the Refresh button to refresh the login statistics				

4G Vehicle Gateway

Appendix A GPL WRITTEN OFFER

This product incorporates open source software components covered by the terms of third party copyright notices and license agreements contained below.

GPSTabel

Version 1.4.4

Copyright (C) 2002-2005 Robert Lipe<robertlipe@usa.net>

GPL License: <https://www.gpsbabel.org/>

Curl

Version 7.19.6

Copyright (c) 1996-2009, Daniel Stenberg, <daniel@haxx.se>.

MIT/X derivate License: <https://curl.haxx.se/>

OpenSSL

Version 1.0.2m

Copyright (C) 1995-1998 Eric Young (eay@cryptsoft.com)

GPL License: <https://www.openssl.org/>

brctl - ethernet bridge administration

Stephen Hemminger <shemminger@osdl.org>

Lennert Buytenhek <buytenh@gnu.org>

version 1.1

GNU GENERAL PUBLIC LICENSE Version 2, June 1991

tc - show / manipulate traffic control settings

Stephen Hemminger<shemminger@osdl.org>

Alexey Kuznetsov<kuznet@ms2.inr.ac.ru>

version iproute2-ss050330

GNU GENERAL PUBLIC LICENSE Version 2, June 1991

dhcp-fwd — starts the DHCP forwarding agent

Enrico Scholz <enrico.scholz@informatik.tu-chemnitz.de>

version 0.7

GNU GENERAL PUBLIC LICENSE Version 2, June 1991

lftp - Sophisticated file transfer program

Alexander V. Lukyanov <lav@yars.free.net>

version:4.5.x

Copyright (c) 1996-2014 by Alexander V. Lukyanov (lav@yars.free.net)

dnsmasq - A lightweight DHCP and caching DNS server.

4G Vehicle Gateway

Simon Kelley <simon@thekelleys.org.uk>

version:2.72

dnsmasq is Copyright (c) 2000-2014 Simon Kelley

socat - Multipurpose relay

Version: 2.0.0-b8

GPLv2

<http://www.dest-unreach.org/socat/>

LibModbus

Version: 3.0.3

LGPL v2

<http://libmodbus.org/news/>

LibIEC60870

GPLv2

Copyright (C) 1989, 1991 Free Software Foundation, Inc. 59 Temple Place, Suite 330, Boston, MA 02111-1307 USA

<https://sourceforge.net/projects/mrts/>

Openswan

Version: v2.6.38 GNU GENERAL PUBLIC LICENSE Version 2, June 1991

Copyright (C) 1989, 1991 Free Software Foundation, Inc. 59 Temple Place, Suite 330, Boston, MA 02111-1307 USA

Everyone is permitted to copy and distribute verbatim copies of this license document, but changing it is not allowed.

<https://www.openswan.org/>

Opennhp

Version: v0.14.1

OpenNHRP is an NHRP implementation for Linux. It has most of the RFC2332 and Cisco IOS extensions.

Project homepage: <http://sourceforge.net/projects/opennhp>

Git repository: <git://opennhp.git.sourceforge.net/gitroot/opennhp>

LICENSE

OpenNHRP is licensed under the MIT License. See MIT-LICENSE.txt for additional details.

OpenNHRP embeds libev. libev is dual licensed with 2-clause BSD and GPLv2+ licenses. See libev/LICENSE for additional details.

OpenNHRP links to c-ares. c-ares is licensed under the MIT License.

<https://sourceforge.net/projects/opennhp/>

IPSec-tools

Version: v0.8

4G Vehicle Gateway

No GPL be written

<http://ipsec-tools.sourceforge.net/>

PPTP

Version: pptp-1.7.1

GNU GENERAL PUBLIC LICENSE Version 2, June 1991

Copyright (C) 1989, 1991 Free Software Foundation, Inc. 675 Mass Ave, Cambridge, MA 02139, USA

Everyone is permitted to copy and distribute verbatim copies of this license document, but changing it is not allowed.

<http://pptpclient.sourceforge.net/>

PPTPServ

Version: 1.3.4

GNU GENERAL PUBLIC LICENSE Version 2, June 1991

Copyright (C) 1989, 1991 Free Software Foundation, Inc. 675 Mass Ave, Cambridge, MA 02139, USA

Everyone is permitted to copy and distribute verbatim copies

of this license document, but changing it is not allowed. <http://poptop.sourceforge.net/>

L2TP

Version: 0.4

Copying All software included in this package is Copyright 2002 Roaring Penguin Software Inc. You may distribute it under the terms of the GNU General Public License (the "GPL"), Version 2, or (at your option) any later version.

<http://www.roaringpenguin.com/>

L2TPServ

Version: v 1.3.1 GNU GENERAL PUBLIC LICENSE Version 2, June 1991

Copyright (C) 1989, 1991 Free Software Foundation, Inc. 59 Temple Place, Suite 330, Boston, MA 02111-1307 USA

Everyone is permitted to copy and distribute verbatim copies of this license document, but changing it is not allowed.

<http://www.xelerance.com/software/xl2tpd/>

Mpstat: from sysstat, system performance tools for Linux

Version: 10.1.6

Copyright: (C) 1999-2013 by Sebastien Godard (sysstat <at> orange.fr)

SSHD: dropbear, a SSH2 server

Version: 0.53.1

Copyright: (c) 2002-2008 Matt Johnston

Libncurses: The ncurses (new curses) library is a free software emulation of curses in System V Release 4.0 (SVr4), and more.

4G Vehicle Gateway

Version: 5.9

Copyright: (c) 1998,2000,2004,2005,2006,2008,2011,2015 Free Software Foundation, Inc., 51 Franklin Street, Boston, MA 02110-1301, USA

MiniUPnP: The miniUPnP daemon is an UPnP IGD (internet gateway device) which provide NAT traversal services to any UPnP enabled client on the network.

Version: 1.7

Copyright: (c) 2006-2011, Thomas BERNARD

CoovaChilli is an open-source software access controller for captive portal (UAM) and 802.1X access provisioning.

Version: 1.3.0

Copyright: (C) 2007-2012 David Bird (Coova Technologies) <support@coova.com>

Krb5: Kerberos is a network authentication protocol. It is designed to provide strong authentication for client/server applications by using secret-key cryptography.

Version: 1.11.3

Copyright: (C) 1985-2013 by the Massachusetts Institute of Technology and its contributors

OpenLDAP: a suite of the Lightweight Directory Access Protocol (v3) servers, clients, utilities, and development tools.

Version: 2.4

Copyright: 1998-2014 The OpenLDAP Foundation

Samba3311: the free SMB and CIFS client and server for UNIX and other operating systems

Version: 3.3.11

Copyright: (C) 2007 Free Software Foundation, Inc. <<http://fsf.org/>>

NTPClient: an NTP (RFC-1305, RFC-4330) client for unix-alike computers

Version: 2007_365

Copyright: 1997, 1999, 2000, 2003, 2006, 2007 Larry Doolittle

exFAT: FUSE-based exFAT implementation

Version: 0.9.8

Copyright: (C) 2010-2012 Andrew Nayenko

NTFS_3G: The NTFS-3G driver is an open source, freely available read/write NTFS driver for Linux, FreeBSD, Mac OS X, NetBSD, Solaris and Haiku.

Version: 2009.4.4

Copyright: (C) 1989, 1991 Free Software Foundation, Inc., 51 Franklin Street, Fifth Floor, Boston, MA 02110-1301 USA

mysql-5_1_72: a release of MySQL, a dual-license SQL database server

Version: 5.1.72

4G Vehicle Gateway

Copyright: (c) 2000, 2013, Oracle and/or its affiliates

FreeRadius: a high performance and highly configurable RADIUS server

Version: 2.1.12

Copyright: (C) 1999-2011 The FreeRADIUS server project and contributors

Linux IPv6 Router Advertisement Daemon – radvd

Version: V 1.15

Copyright (c) 1996,1997 by Lars Fenneberg<lf@elemental.net>

BSD License: <http://www.litech.org/radvd/>

WIDE-DHCPv6

Dynamic Host Configuration Protocol for IPv6 (DHCPv6) clients, servers, and relay agents.

Version: 20080615

Copyright (C) 1998-2004 WIDE Project.

BSD License: <https://sourceforge.net/projects/wide-dhcpv6/>

Python version 2.7.12

This Python distribution contains no GNU General Public Licensed (GPLed) code so it may be used in proprietary projects just like prior Python distributions. There are interfaces to some GNU code but these are entirely optional

OpenPAM Radula

This software was developed for the FreeBSD Project by ThinkSec AS and Network Associates Laboratories, the Security Research Division of Network Associates, Inc. under DARPA/SPAWAR contract N66001-01-C-8035 ("CBOSS"), as part of the DARPA CHATS research program.

ISC DHCP Version 4.3.5

Copyright (c) 2004-2016 by Internet Systems Consortium, Inc. ("ISC")